

WLAD.01 Ground Plane and Clearance Evaluation Test Report TE150054



Any unauthorized use, reproduction, dissemination, distribution or other disclosure of the contents is strictly prohibited. All copyrights, trademarks and any other intellectual property rights related are owned by Taoglas Group Holding Limited.

Table of Contents

1	Introduction	4
2	Prerequisite: Full Board Performance Evaluation	4
2.1	Antenna Matching Circuit	7
3	Measurement Methodology	8
4	Ground Plane Size Evaluation – Long Side	9
4.1	Return Loss and VSWR	9
4.2	Efficiency, Peak Gain and Average Gain	10
4.3	Conclusion	11
5	Ground Plane Size Evaluation – Short Side	12
5.1	Return Loss and VSWR	12
5.2	Efficiency, Peak Gain and Average Gain	13
5.3	Conclusion	14
6	Ground Plane Size Evaluation – Overall Size	15
6.1	Return Loss and VSWR	15
6.2	Efficiency, Peak Gain and Average Gain	16
6.3	Conclusion	17
7	Ground Plane Size Evaluation – Circular Board	18
7.1	Return Loss and VSWR (25mm & 20mm Diameter)	19
7.2	Efficiency, Peak Gain, Average Gain (25mm & 20mm Diameter)	20
7.3	Conclusion	21
8	Extremely Small Board sizes	22
8.1	Return Loss and VSWR (16*20mm, 12*20mm and 12*11mm)	22
8.2	Efficiency, Peak Gain, Average Gain (16*20mm, 12*20mm and 12*11mm)	23
8.3	Conclusion	24
9	Clearance Evaluation.....	25
9.1	Return Loss and VSWR (Left-Hand Side vs Right-Hand Side)	26
9.2	Efficiency, Peak Gain, Average Gain (Left-Hand Side vs Right-Hand Side)	27
9.3	Return Loss and VSWR (LHS 5mm, 10mm, 15mm, 20mm)	28
9.4	Efficiency, Peak Gain, Average Gain (LHS 5mm, 10mm, 15mm, 20mm)	29
9.5	Return Loss and VSWR (Above, Under, Front, Below)	31
9.6	Efficiency, Peak Gain, Average Gain (Above, Under, Front, Below)	32
9.7	Conclusion	33

10	Effect above Ground Plane	34
10.1	WLAD.01 positioned above centre of 300mm x 300mm ground plane	34
10.1.1	Return Loss and VSWR	35
10.1.2	Efficiency, Peak Gain & Average Gain	36
10.2	WLAD.01 positioned above edge of 300mm x 300mm ground plane	38
10.2.1	Return Loss and VSWR	38
10.2.2	Efficiency	39
10.2.3	Peak Gain	40
10.2.4	Average Gain	40
10.3	WLAD.01 positioned above centre 150mm x 90mm ground plane.....	41
10.3.1	Return Loss and VSWR	41
10.3.2	Efficiency	42
10.3.3	Peak Gain	43
10.3.4	Average Gain	43
10.4	WLAD.01 positioned above edge of 150mm x 90mm ground plane	44
10.4.1	Return Loss and VSWR	44
10.4.2	Efficiency	45
10.4.3	Peak Gain	46
10.4.4	Average Gain	46
10.5	Conclusion.....	47

1 Introduction

Evaluation of ground plane size influence on Taoglas WLA.01 antenna efficiency (when mounted on the WLAD.01 evaluation board) will be reported on in this document. This will be done by subsequently shortening one of the ground plane sides (and then the other) and measuring the antenna efficiency at the antenna operation frequency range from 2.4GHz to 2.5GHz.

Next, evaluation of metal clearance for the WLA.01 antenna will be done by placing metallic mock-up objects in its vicinity and evaluating the antenna performance at each step.

Equipment Used:

- Copper Mountain Planar 804/1
- ETS-Lindgren Anechoic Chamber

The WLAD.01 evaluation boards come from batch number T0349058.

2 Prerequisite: Full Board Performance Evaluation

First starting point is performance evaluation of the full WLAD.01 board size and comparison to the data sheet. This is done just for return loss and efficiency, as other performance figures (VSWR, peak gain and average gain) are strongly correlated.

The return loss for two unaltered evaluation boards (the state they are when unpacked from factory packaging, "Sample 1" and "Sample 2") is shown in Figure 2 along with the return loss for one evaluation board whose matching circuit was altered in order to achieve better performance at 2.45GHz ("Sample matched"). As seen the altered board has significantly better return loss value than the factory ones.

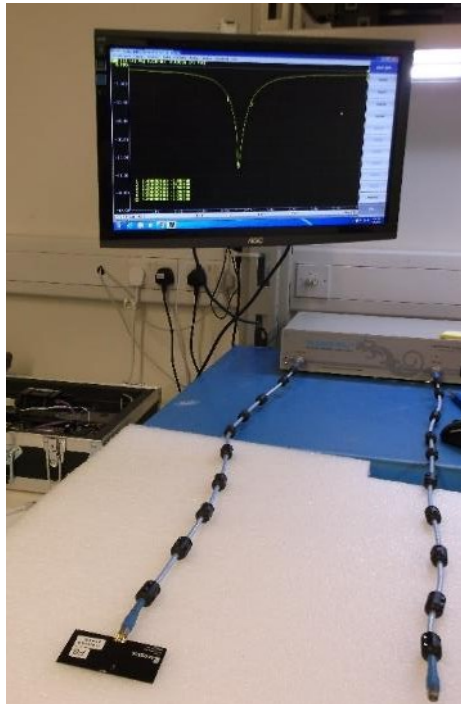

Figure 1. S_{11} measurement set-up

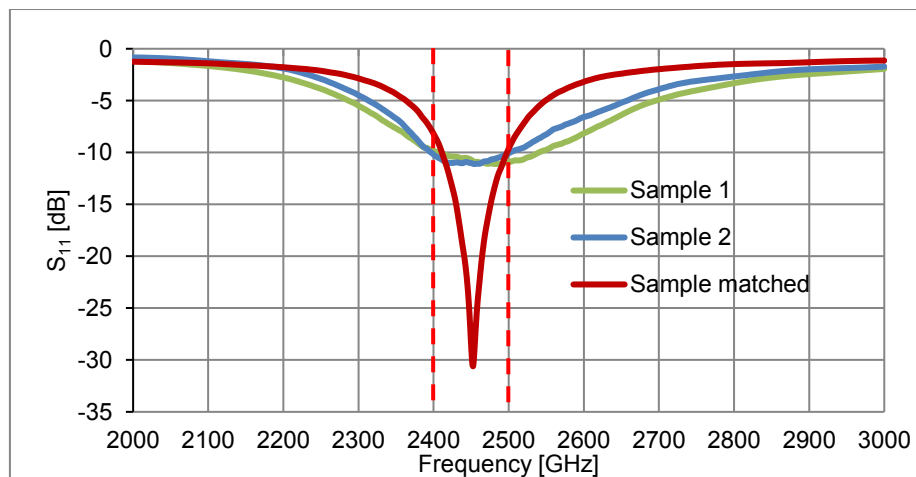

Figure 2. S_{11} for the three WLAD.01 samples

Next, efficiency is measured for all three WLAD.01 evaluation boards, and the results in Figure 4 show that the “Sample matched” antenna performs better than the two factory samples. Comparing these values to the datasheet, significant difference is seen – datasheet states efficiency of 84% at 2.45 GHz while actual efficiency for “Sample matched” antenna is 71%.



Figure 3. Chamber measurements set-up

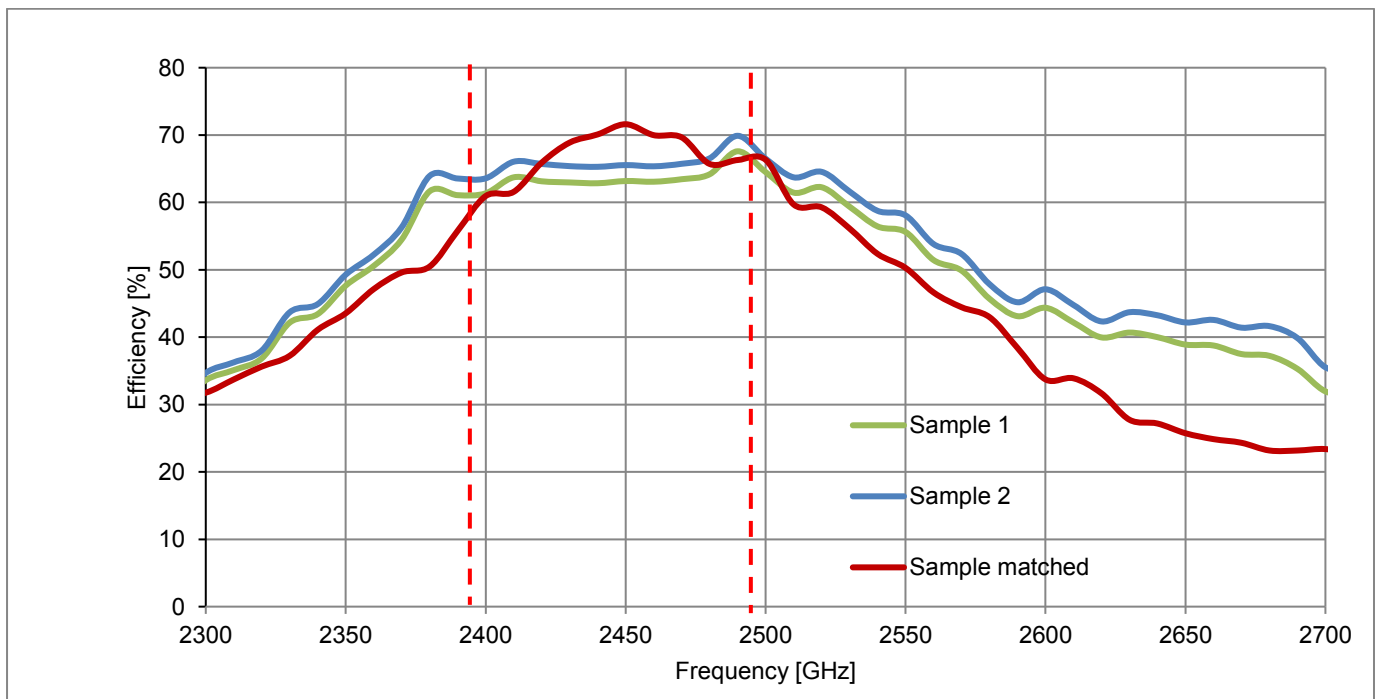

Figure 4. Efficiency for the three WLAD.01 samples

2.1 Antenna Matching Circuit

The WLAD.01 evaluation board comes pre-matched with an L-network composed of S1 and S2 elements and with the Fine Tuning Element (FTE) as presented in *Figure 5*. A position for S2 element is also available on the board but it has not to be used – it allows for another degree of freedom when it is needed for matching.

Table 1 shows the values for all of the elements for pre-matched values (Sample 1 and Sample 2) and newly matched (Sample matched.)

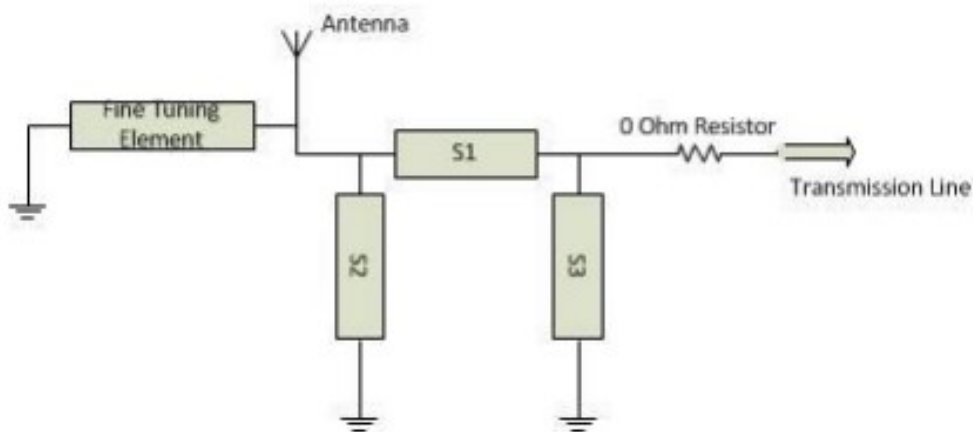

Figure 5. WLA.01 matching circuit diagram

Table 1 Matching values for WLAD.01 boards

	Pre-matched (Sample 1 and Sample 2)	Sample Matched
Fine Tuning Element (FTE)	4.7 pF	4.7 pF
S1	3.3 nH	1.8 pF
S2	-	-
S3	1.2 pF	0.5 pF

3 Measurement Methodology

The adopted method for these studies will be as presented in Figure 6. Due to obvious difference in efficiency performance when the antenna is better matched this methodology is adopted. This means that the antenna will be re-matched each time it detunes due to cutting in order to measure the best possible efficiency for the case. The starting matching will be as for “Sample matched” antenna.

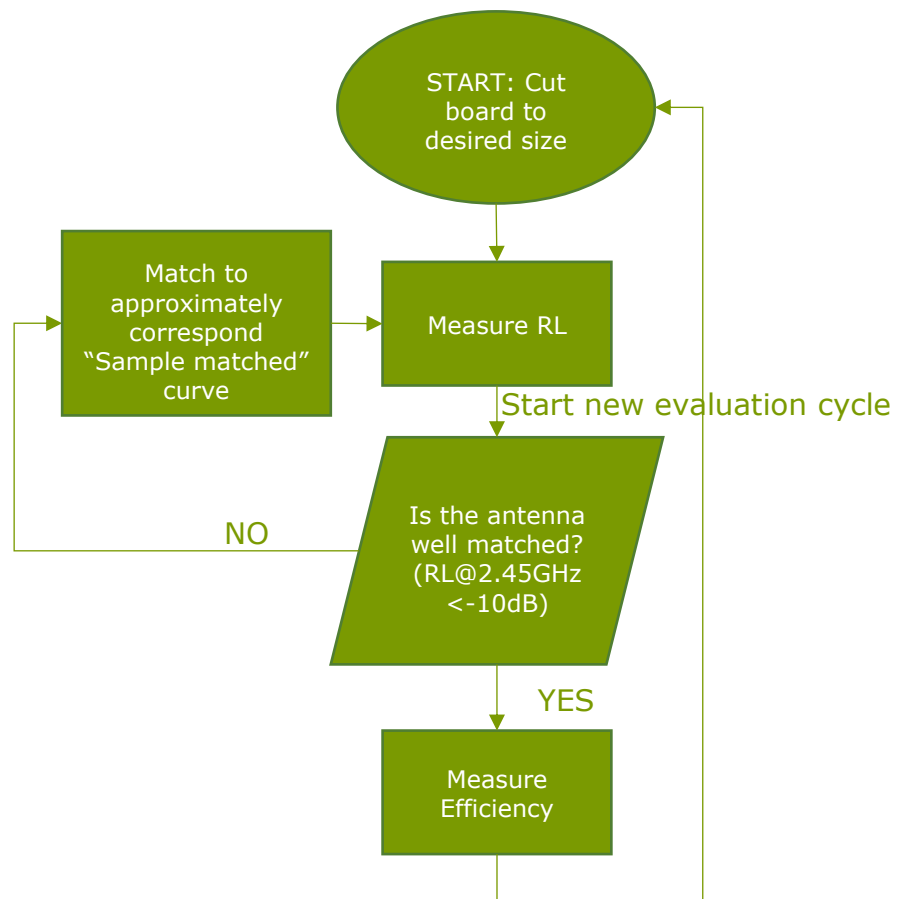

Figure 6. Flowchart of evaluation methodology

4 Ground Plane Size Evaluation – Long Side

The influence of the long side of the ground plane, while the short side is constantly 40mm, is evaluated following the methodology presented in Figure 6. The following lengths are tested: 80mm, 70mm, 60mm, 50mm, 40mm, 30mm, 20mm, and 16mm.

The antenna needed to be re-matched at following sizes: 40*40 mm (FTE=5pF, S1=1.3pF, S3=1.2pF), and 20*40mm (FTE=5pF, S1=1.5pF, S3=1.3pF).

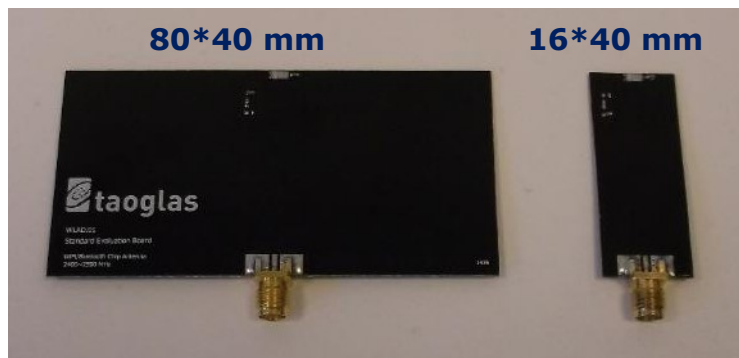

Figure 7. Antenna prototypes (biggest and smallest) for long side ground plane size evaluation

4.1 Return Loss and VSWR

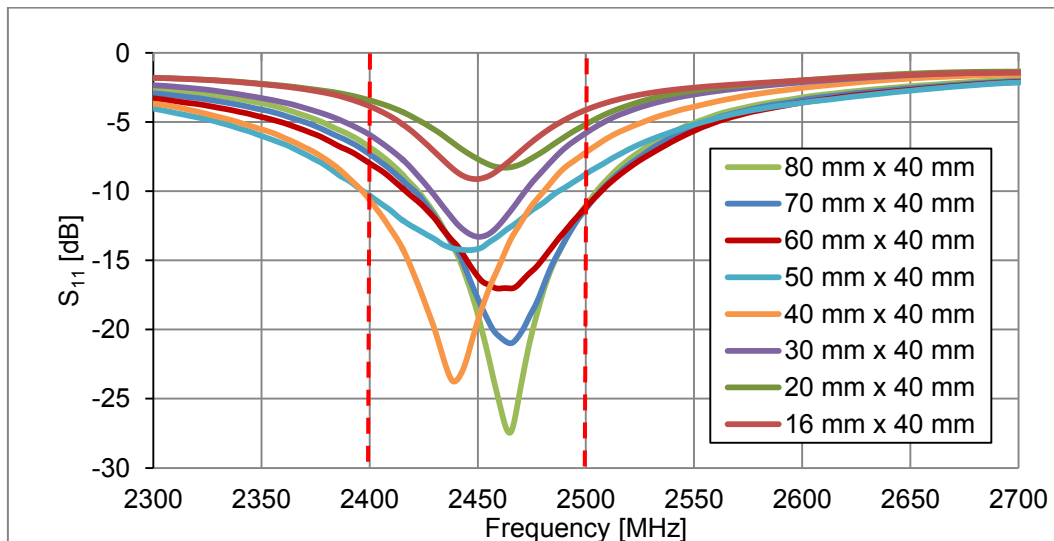

Figure 8. S_{11} plot for 2400-2500MHz band

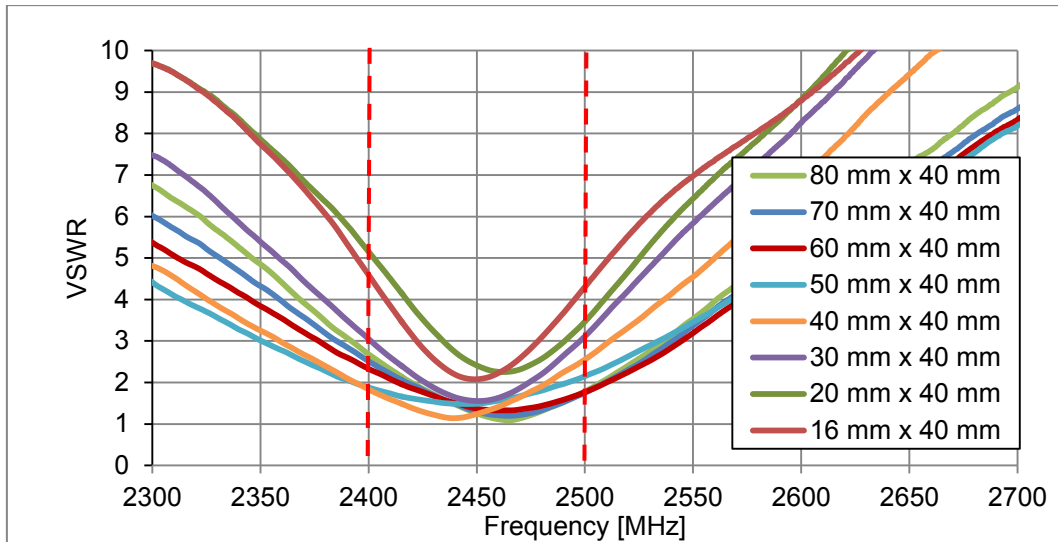

Figure 9. VSWR plot for 2400-2500MHz band

4.2 Efficiency, Peak Gain and Average Gain

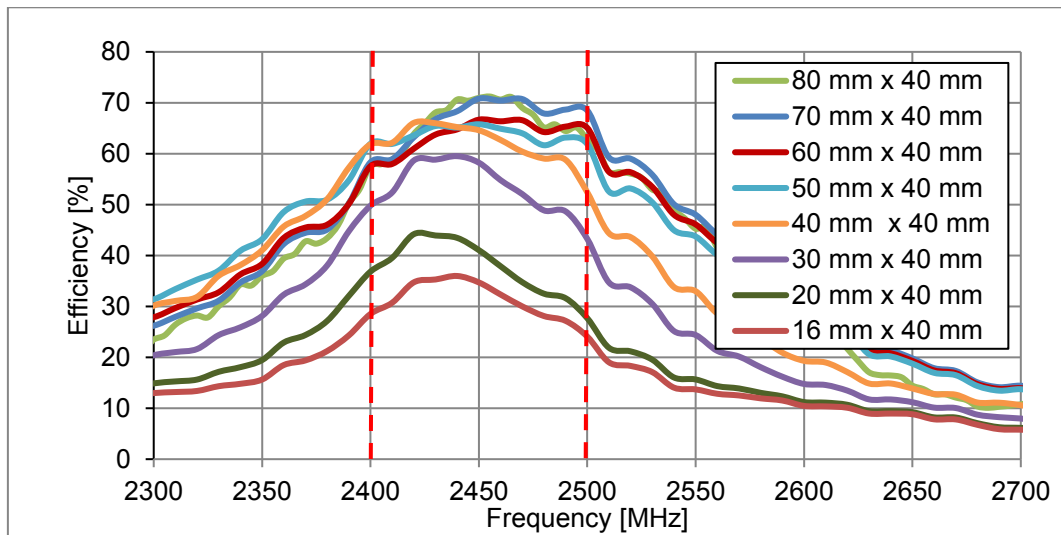

Figure 10. Efficiency plot for 2400-2500MHz band

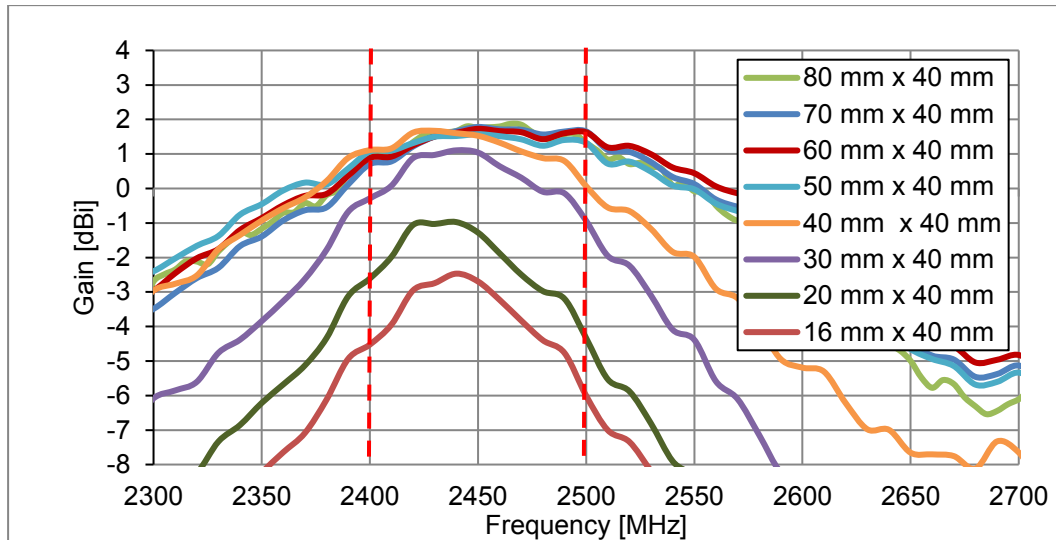

Figure 11. Peak Gain plot for 2400-2500MHz band

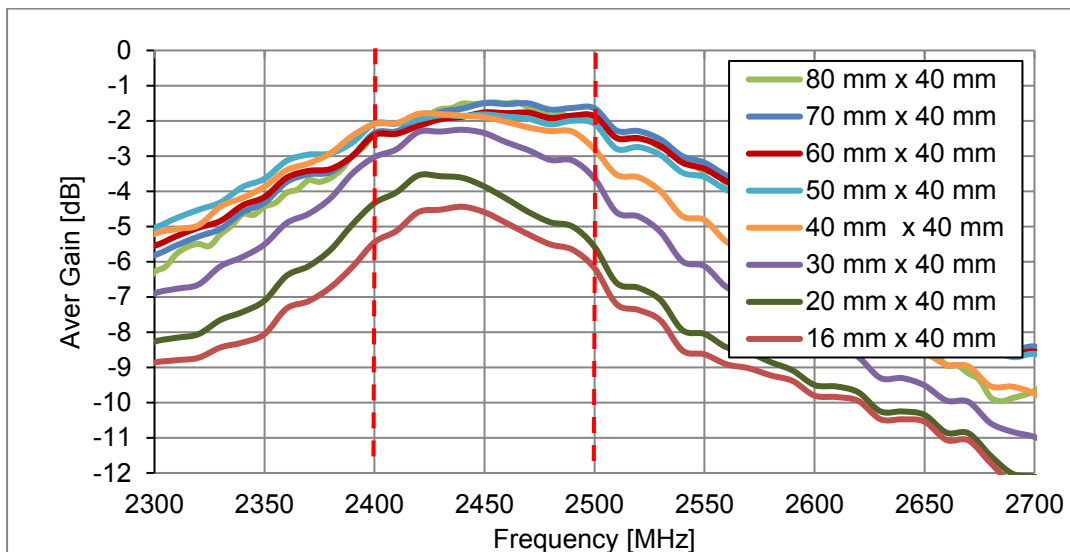

Figure 12. Average Gain plot for 2400-2500MHz band

4.3 Conclusion

The WLAD.01 board demonstrates good return loss and efficiency performance for long side length between 80mm and 50mm without any need for re-matching. After re-matching for 40mm length the performance is only slightly affected. For subsequent sizes of 30mm, 20mm, and 16mm the performance is increasingly negatively impacted for return loss and efficiency. The 16mm length is the smallest possible due to evaluation board outline, and CPW trace geometry. For this smallest size of 16*40mm the efficiency is between 25% and 30% for the 2400-2500MHz band.

5 Ground Plane Size Evaluation – Short Side

The influence of the short side of the ground plane, while the long side is constantly 80mm, is evaluated following the methodology presented in Figure 6. The following lengths are tested: 40mm, 35mm, 30mm, 25mm, and 20mm.

The antenna did not need to be re-matched at any of the steps.

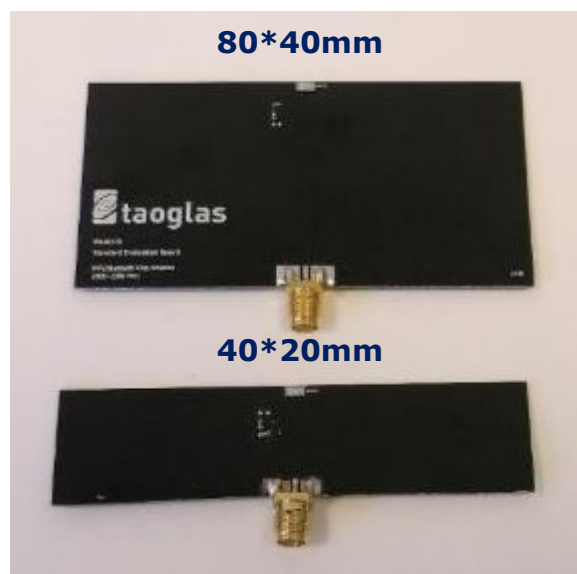

Figure 13. Antenna prototypes (biggest and smallest) for short side ground plane size evaluation

5.1 Return Loss and VSWR

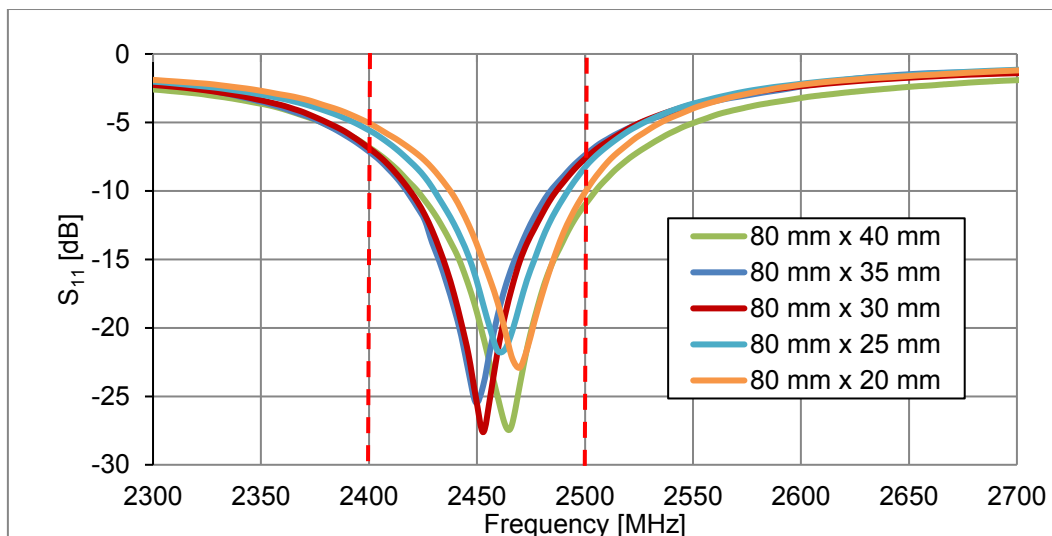

Figure 14. S_{11} plot for 2400-2500MHz band

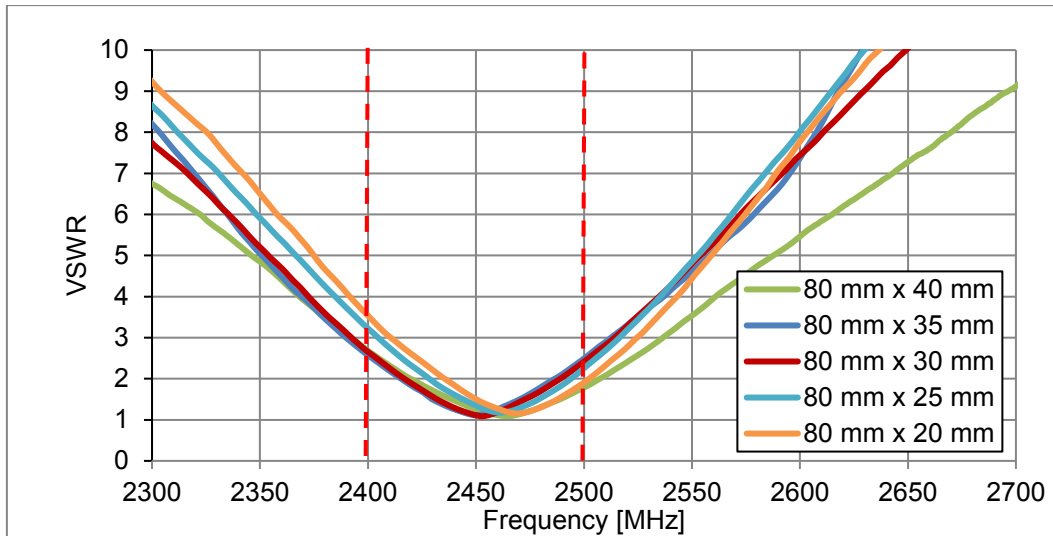

Figure 15. Return Loss plot for 2400-2500MHz band

5.2 Efficiency, Peak Gain and Average Gain

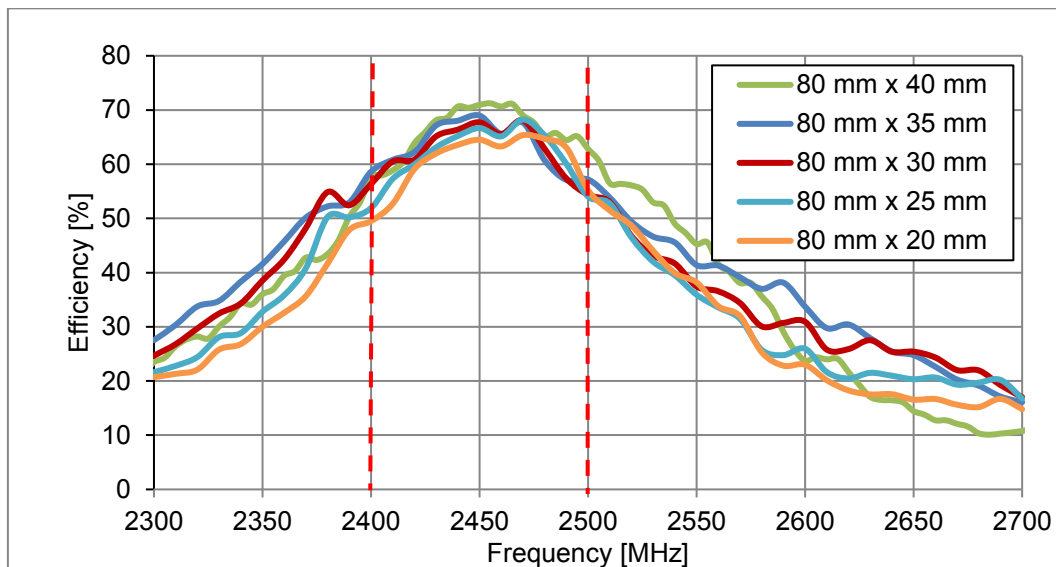

Figure 16. Efficiency plot for 2400-2500MHz band

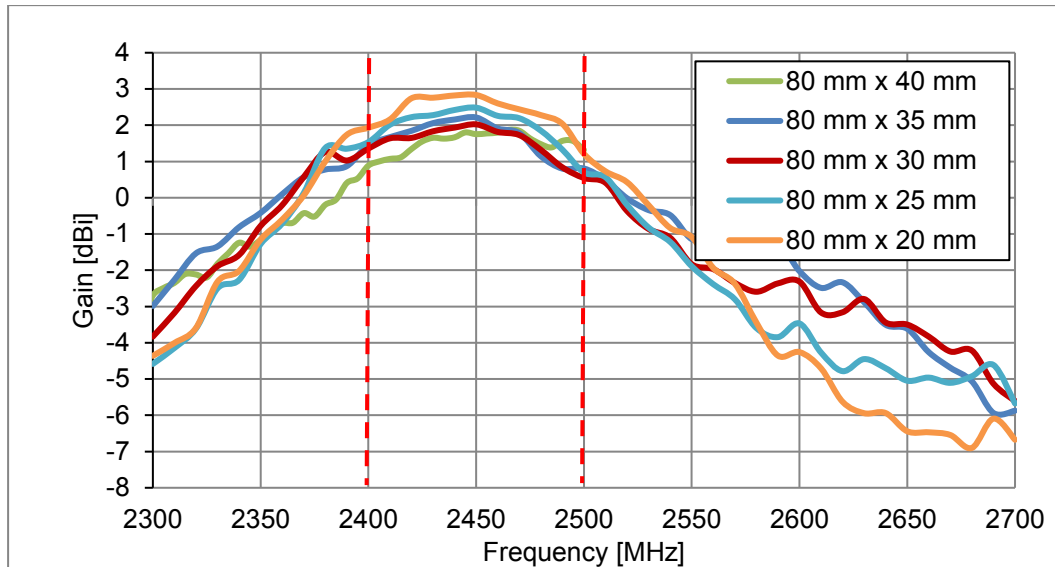

Figure 17. Peak Gain plot for 2400-2500MHz band

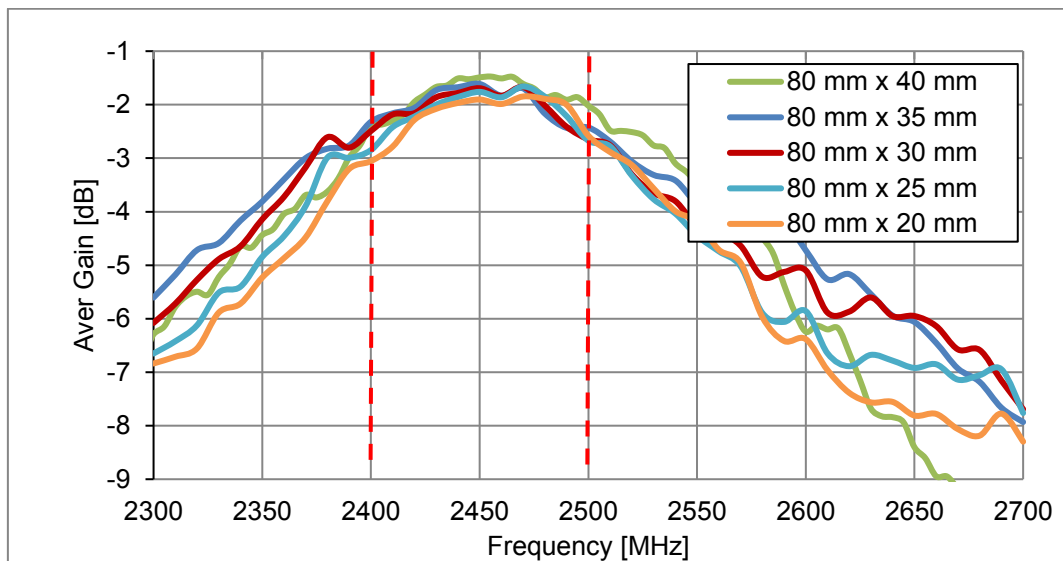

Figure 18. Average Gain plot for 2400-2500MHz band

5.3 Conclusion

From S_{11} and efficiency measurements it can be concluded that as long as the long side is 80mm the short size can be as short as 20mm without any influence on WLA.01 antenna performance. In Figure 16 it can be noted that there is a slight gradual decrease in efficiency (around 1%) with each subsequent size decrease, however opposite trend is noted for the peak gain in Figure 12. This is because the radiation pattern becomes slightly more directive with the short side length decrease. The same trend was not noted for the long side length decrease.

6 Ground Plane Size Evaluation – Overall Size

The influence of the overall size of the ground plane is evaluated following the methodology presented in Figure 6. Taking into consideration already observed performance influence the following sizes are tested: 60*30mm, 40*30mm, 30*20mm, and 20*20mm.

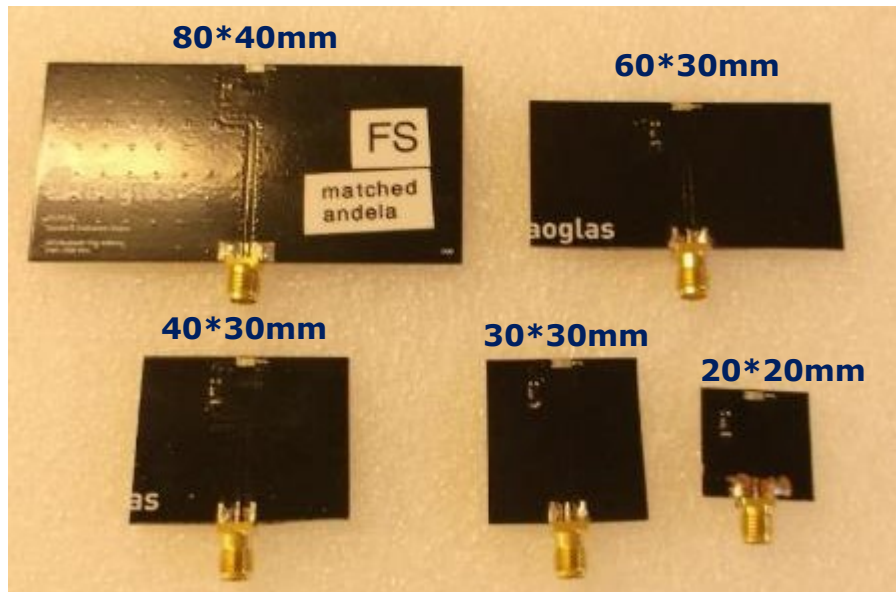

Figure 19. Different board size prototypes

The antenna needed to be re-matched at following sizes: 40*30mm (FTE=4.7pF, S1=1.3pF, S3=1pF), and 20*20 mm (FTE=4.7pF, S1=1.8pF, S3=1.2pF).

6.1 Return Loss and VSWR

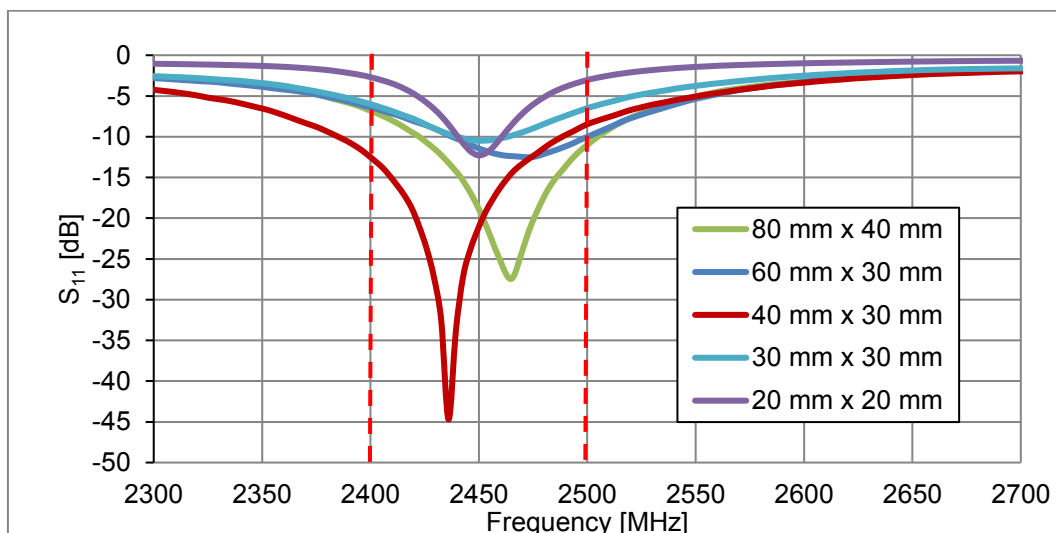

Figure 20. S_{11} plot for 2400-2500MHz band

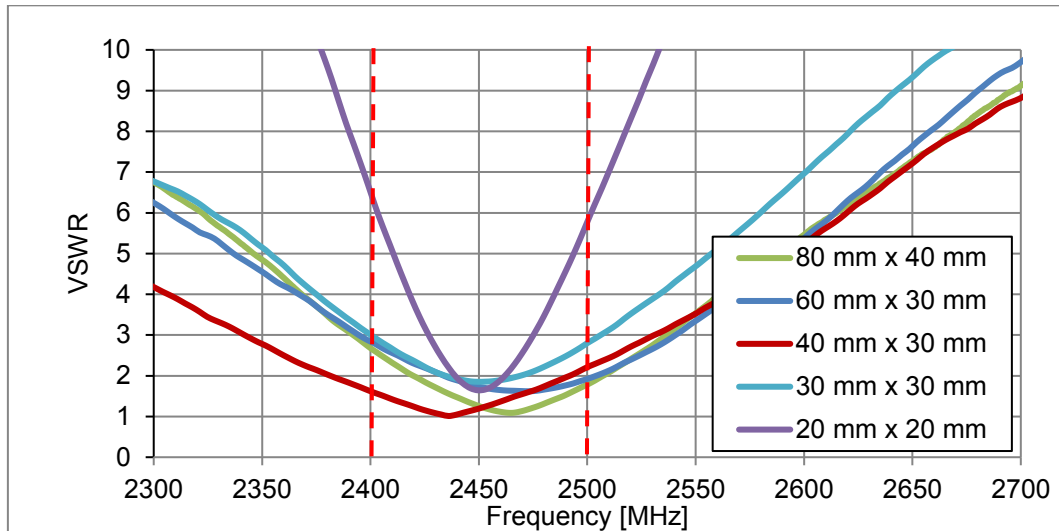

Figure 21. VSWR plot for 2400-2500MHz band

6.2 Efficiency, Peak Gain and Average Gain

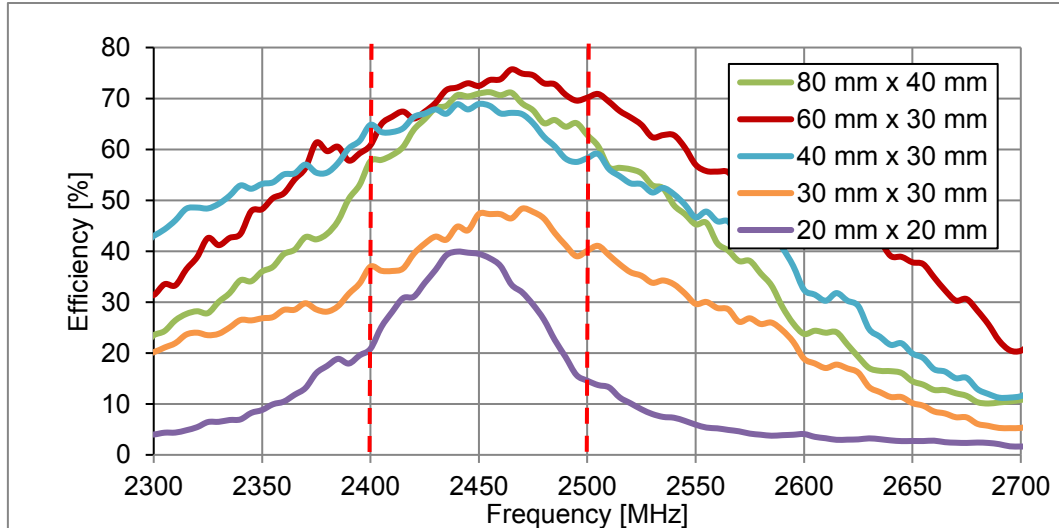

Figure 22. Efficiency plot for 2400-2500MHz band

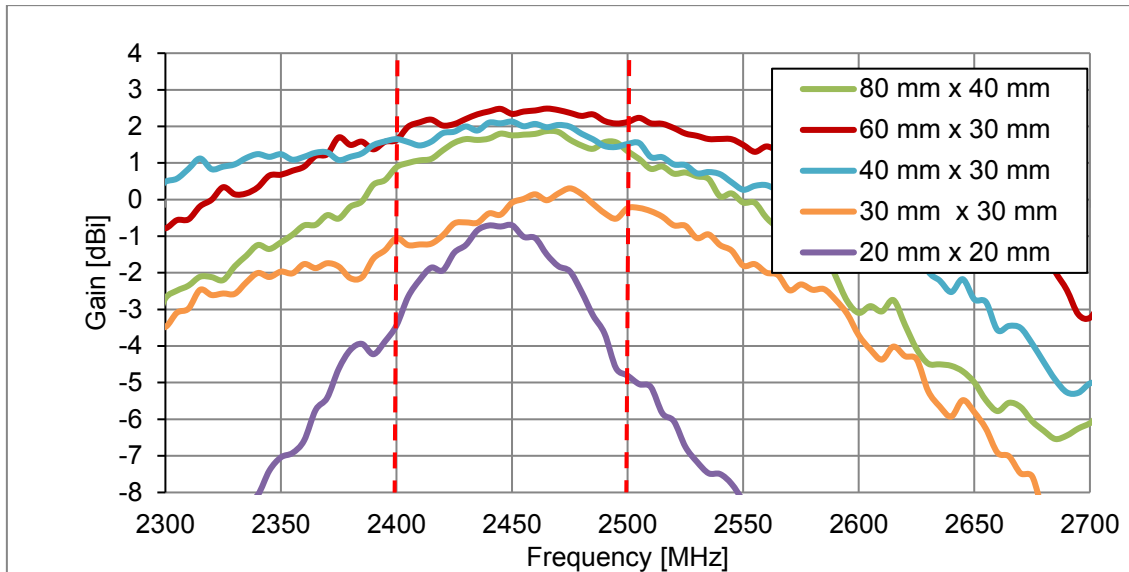

Figure 23. Peak gain plot for 2400-2500MHz band

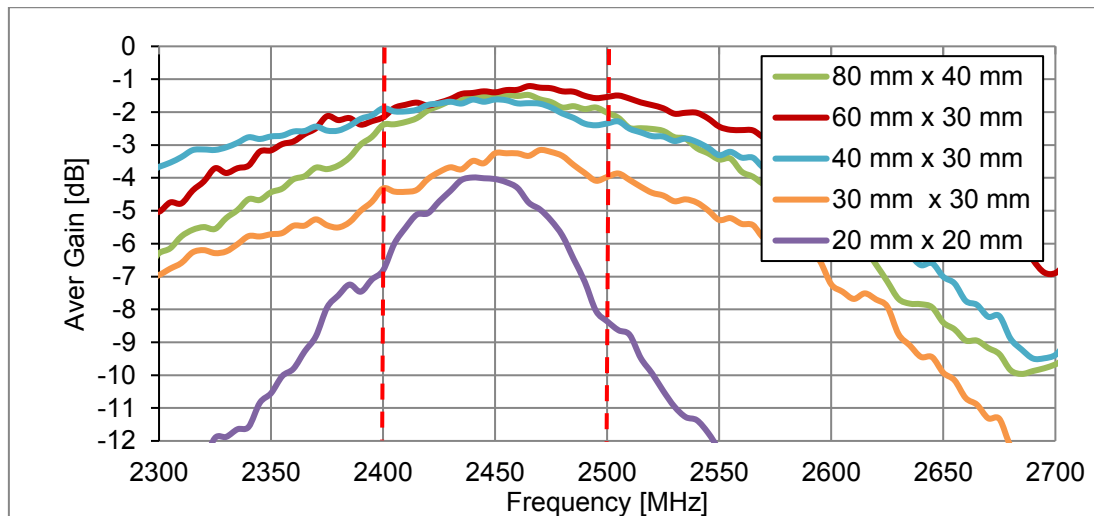

Figure 24. Average gain plot for 2400-2500MHz band

6.3 Conclusion

The antenna can be easily matched for the entire band from 2400MHz to 2500MHz for the following sizes: 60*40mm, and 40*30mm. However for the 30*30mm size only better than -6 dB S_{11} matching is possible, while for 20*20mm it is not achieved on the entire band. This is clearly reflected in the loss of efficiency for the smallest two board sizes. To achieve efficiency higher than 60% the ground plane size should not be smaller than 40*30mm. Better than 40% efficiency is achievable for the 30*30mm size. The smallest size board achieves efficiency between 15% and 30%.

7 Ground Plane Size Evaluation – Circular Board

The following two board sizes were also tested: 25mm diameter and 20mm diameter. These shapes were considered for wearable applications.

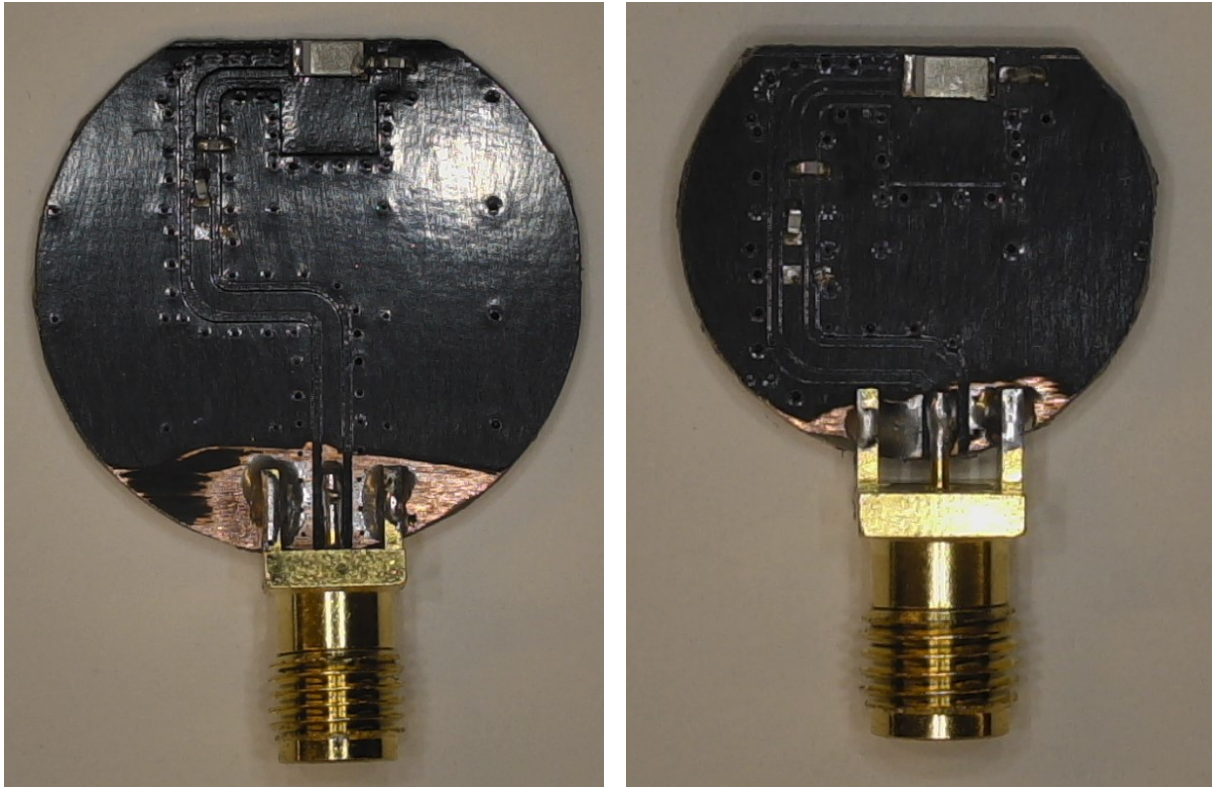

Figure 25. 25mm & 18mm Circular Diameter

The 25mm Circular Board needed to be re-matched with the following values: FTE = 4.3pF, S1 = 1pF, S3 = 2.2pF.

The 18mm Circular Board needed to be re-matched with the following values: FTE = 4.3pF, S2 = 1.3pF, S1 = 1pF

7.1 Return Loss and VSWR (25mm & 20mm Diameter)

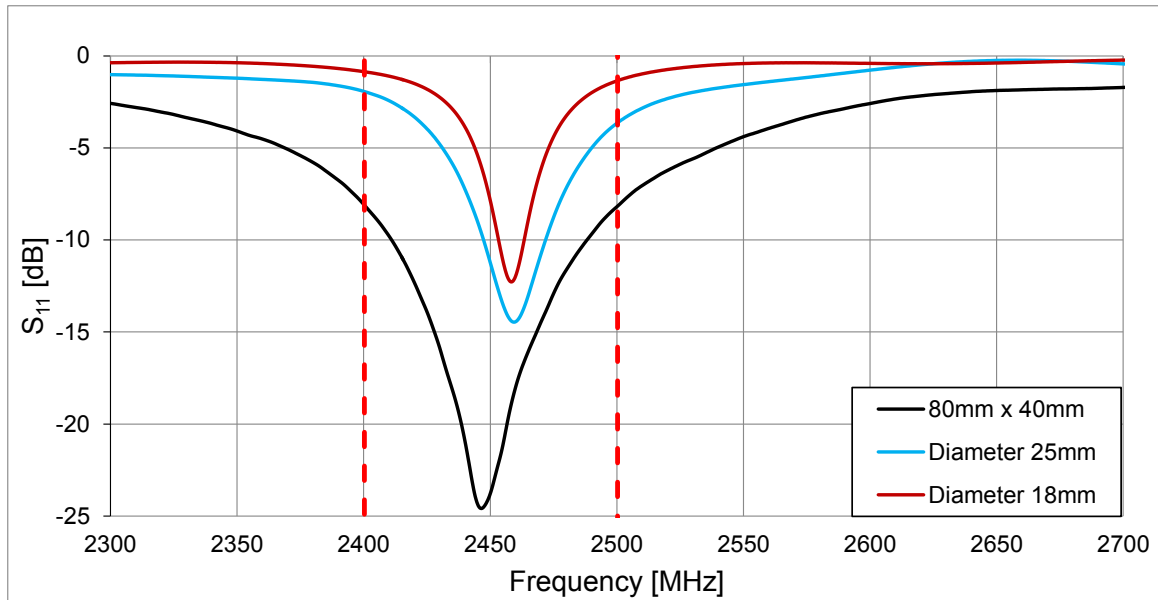

Figure 26. S_{11} Plot for 2400-2500MHz band

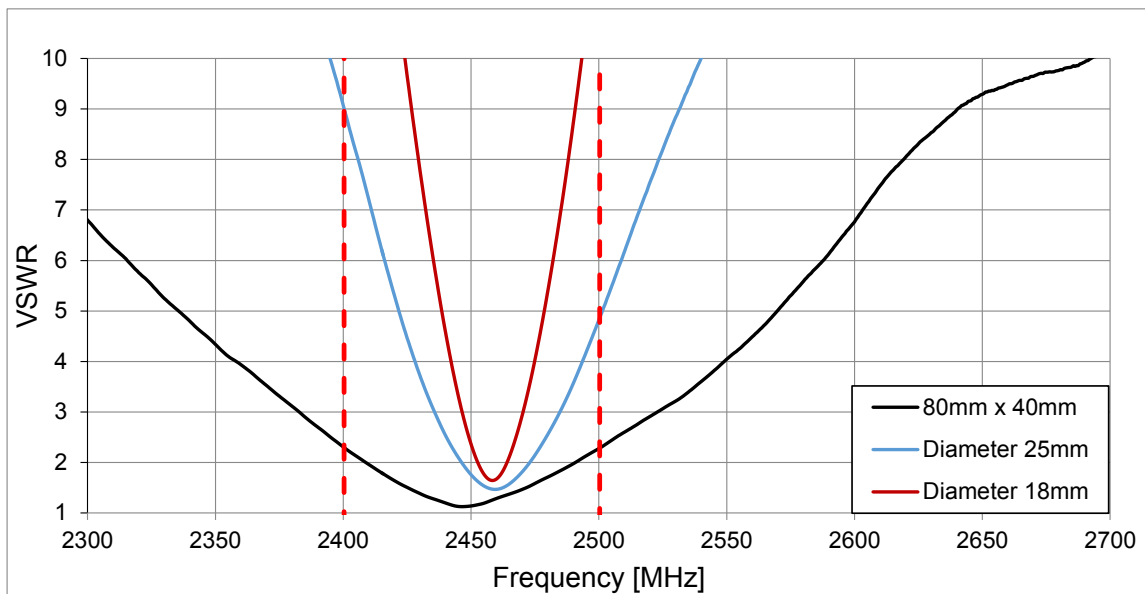

Figure 27. VSWR plot for 2400-2500MHz band

7.2 Efficiency, Peak Gain, Average Gain (25mm & 20mm Diameter)

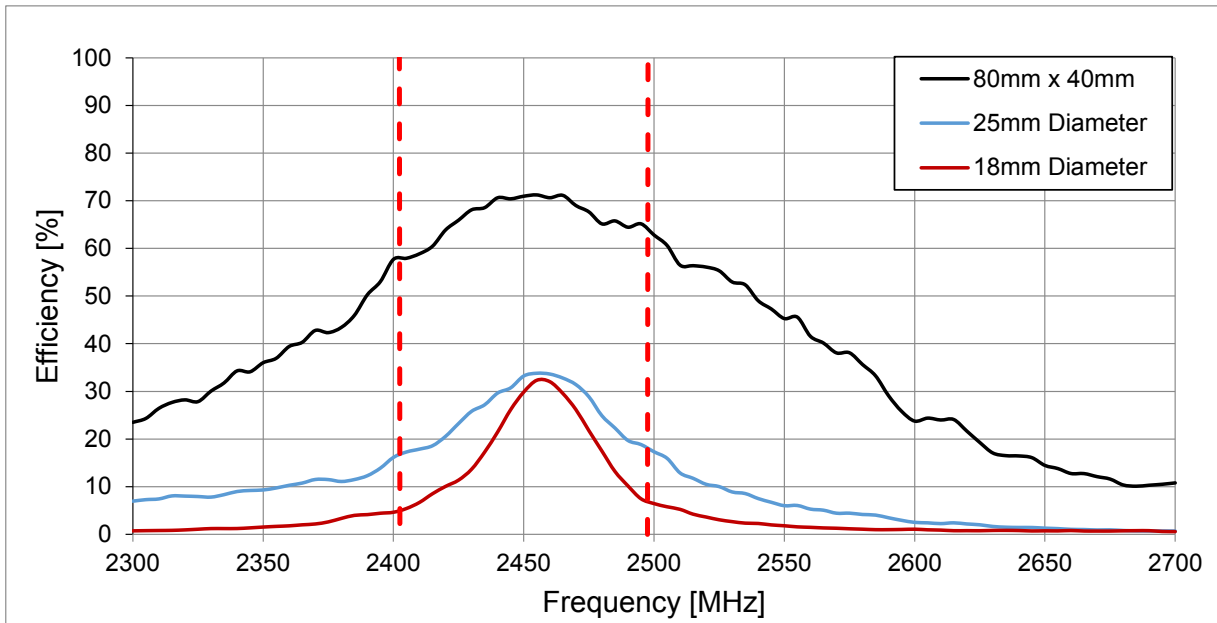

Figure 28. Efficiency plot for 2400-2500MHz band

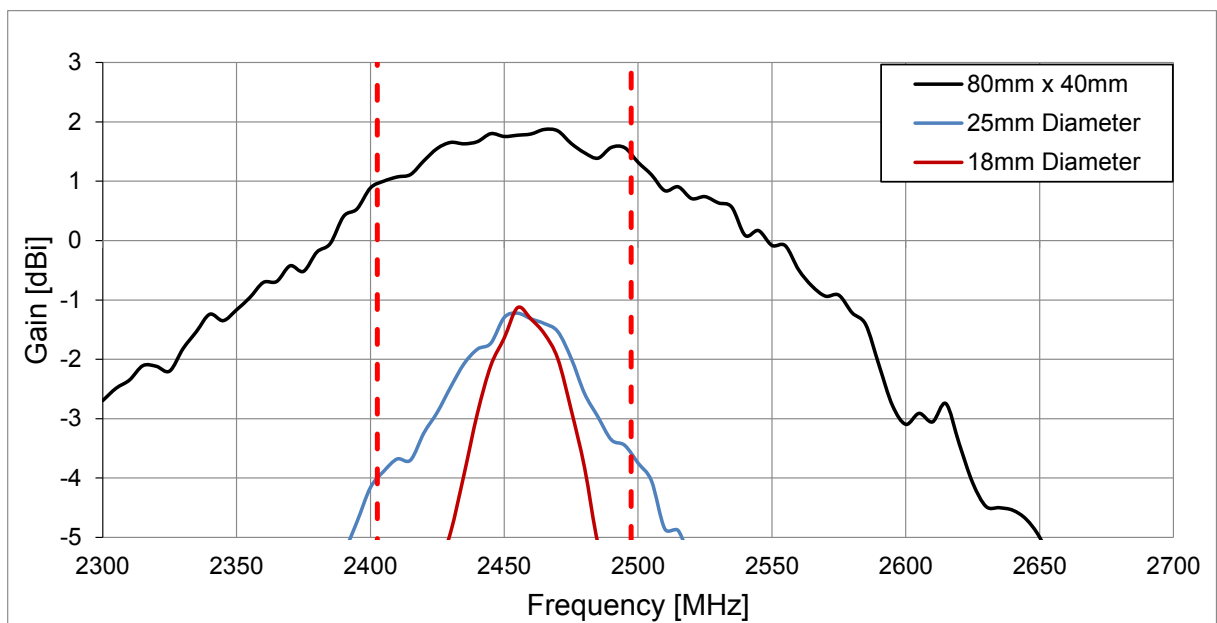

Figure 29. Peak Gain plot for 2400-2500MHz band

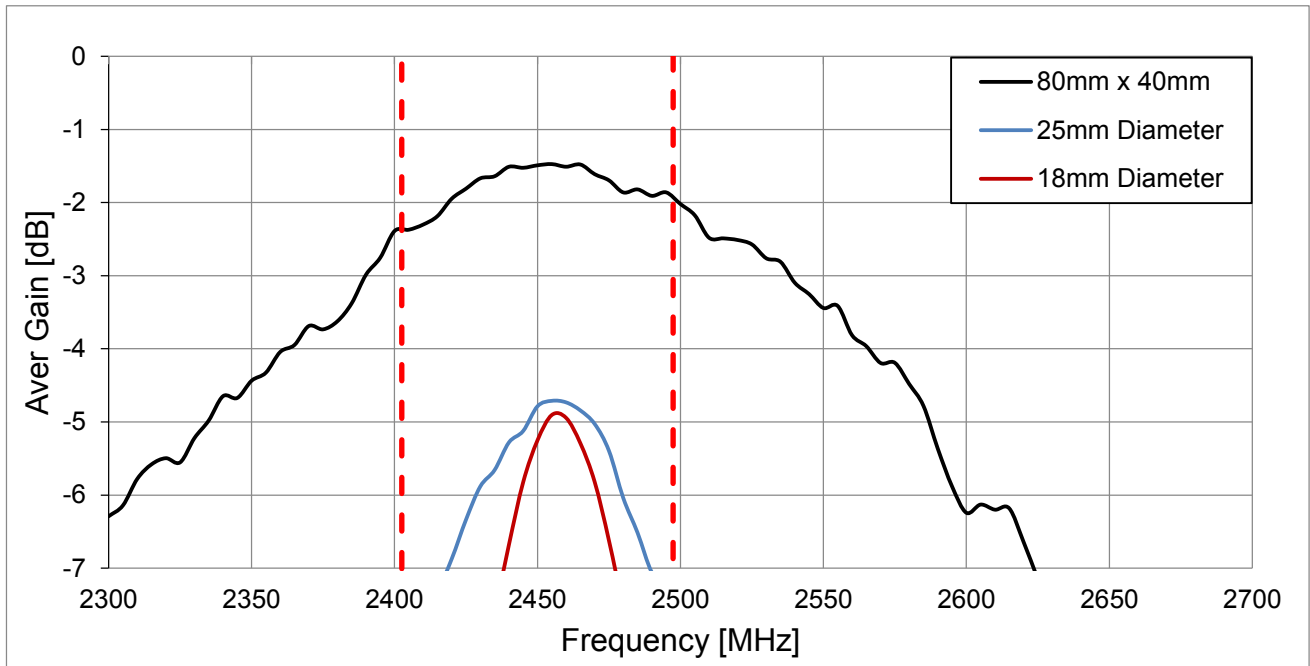

Figure 30. Average Gain plot for 2400-2500MHz band

7.3 Conclusion

The board sizes shows a considerable reduction in bandwidth with a reduced ground plane. Efficiency is less than 40% for the 20mm diameter board. Both boards at the band edges have efficiency lower than 20%. Board sizes smaller than this should show a further reduction in efficiency.

8 Extremely Small Board sizes

The influence of creating the smallest ground plane possible with the evaluation board is considered. Three possible sizes are measured 16*20mm, 12*20mm and finally 12*11mm

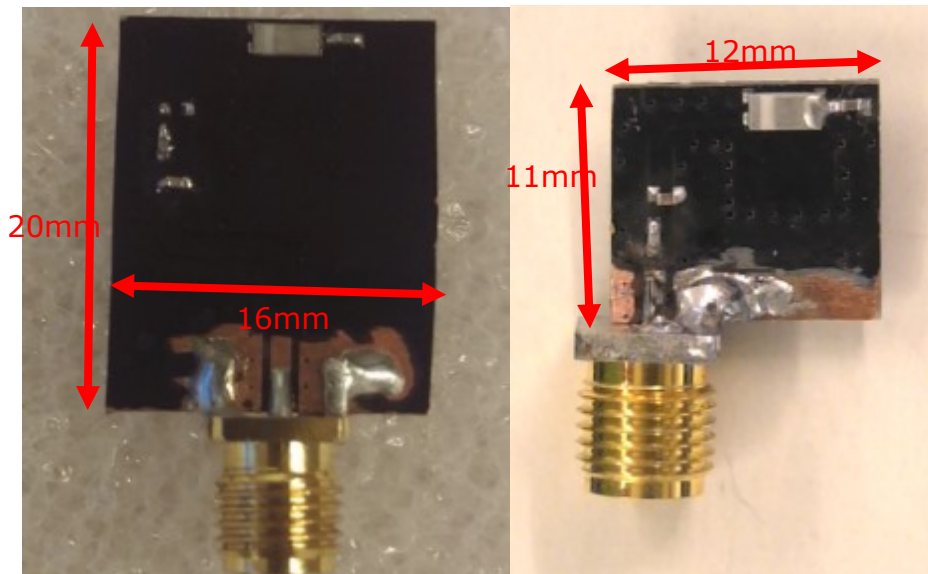

The antenna needed to be re-matched for the board 12*11mm (FTE = 3.9pF, S1=1.8pF, S2 = 1pF), while the other sizes remain equal to 20*20mm matching.

8.1 Return Loss and VSWR (16*20mm, 12*20mm and 12*11mm)

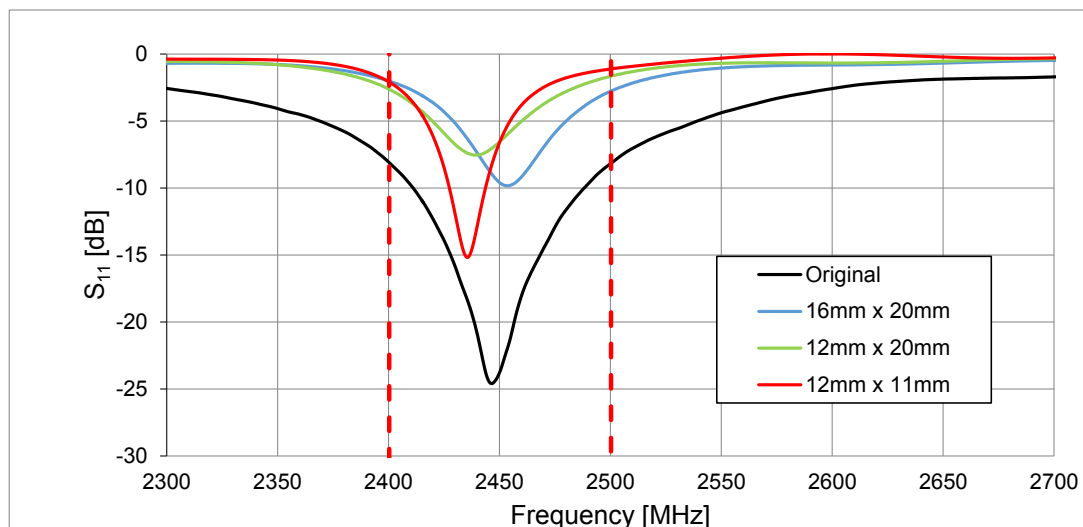

Figure 31. S₁₁ plot for 2400-2500MHz band

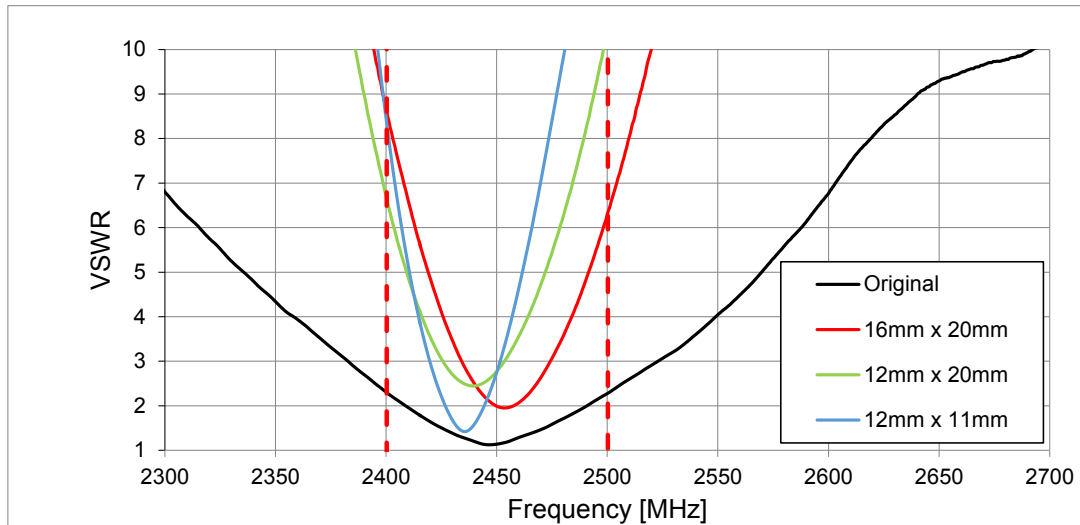

Figure 32. VSWR plot for 2400-2500MHz band

8.2 Efficiency, Peak Gain, Average Gain (16*20mm, 12*20mm and 12*11mm)

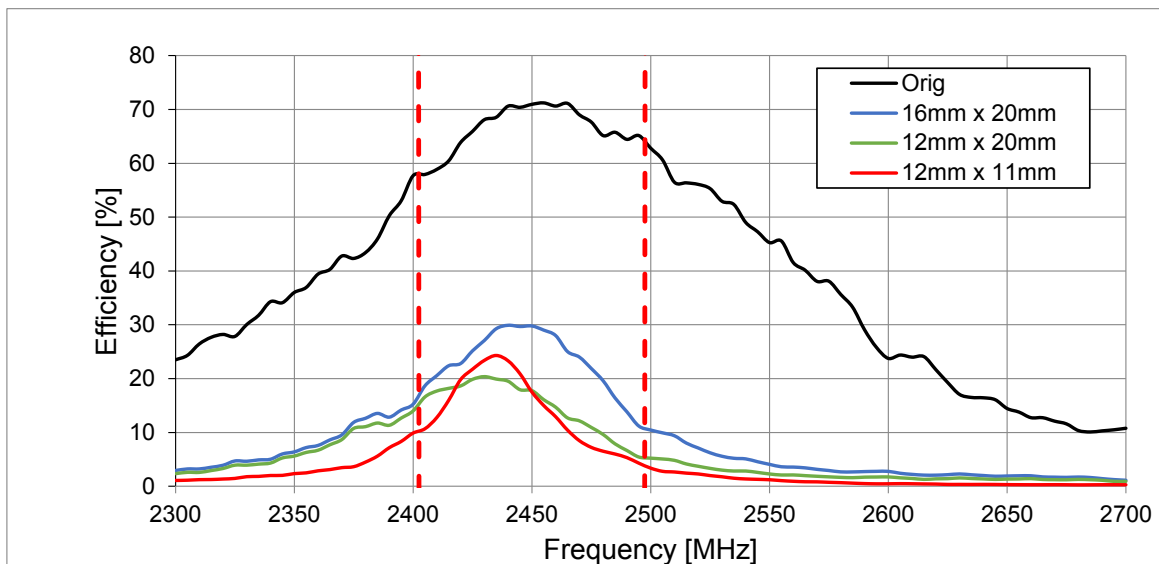

Figure 33. Efficiency plot for 2400-2500MHz band

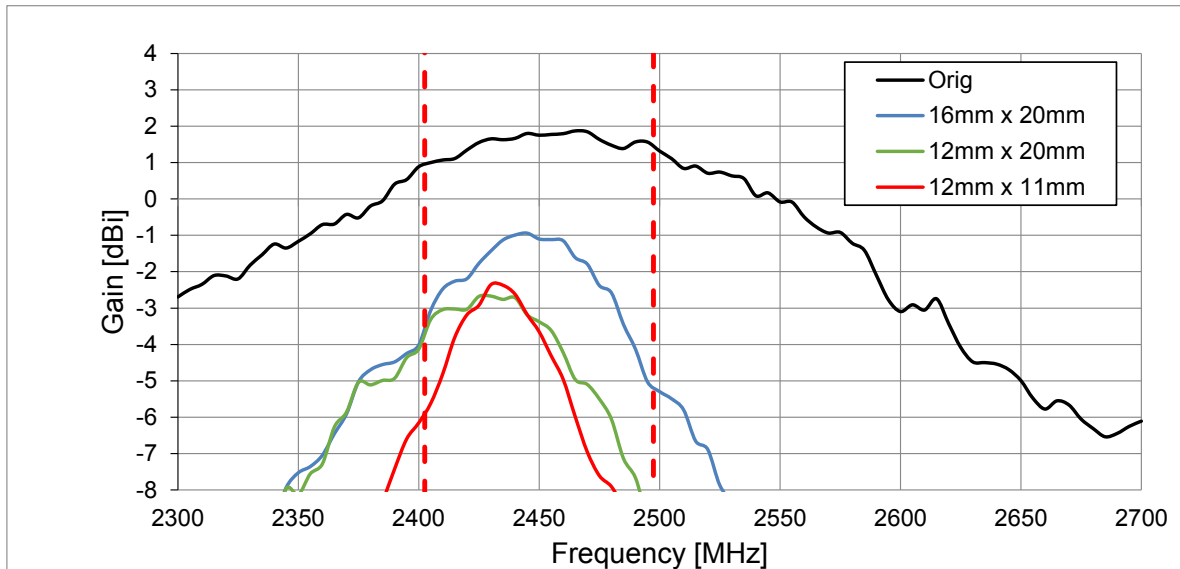

Figure 34. Peak Gain plot for 2400-2500MHz band

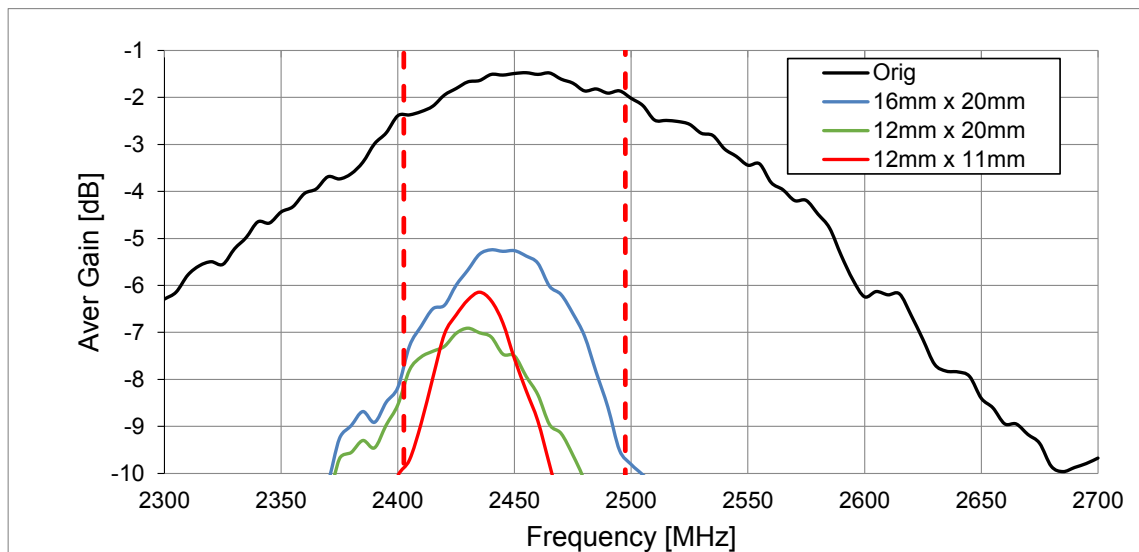

Figure 35. Average Gain plot for 2400-2500MHz band

8.3 Conclusion

The small board sizes show the efficiency further reduces to less than 30% and less than 10% at band edges. These levels of efficiency will result in very poor performance.

9 Clearance Evaluation

The influence of component clearance surrounding the antenna is evaluated. A copper piece (12*12*4mm) representing a module / component is placed around the device in various positions. The copper piece was placed on the left-hand side (LHS) 5mm, 10mm, 15mm, 20mm from the WLA.01 antenna. It was also placed on the right-hand side (RHS) at 5mm and also below and in front of the antenna at 5mm (all at the top side of the PCB board where the antenna is placed, except the front position which is placed in line with antenna away from the edge of PCB). Additionally, it was placed above and under the antenna PCB board at 5mm distance.

The antenna was not re-matched at any of the steps in order to observe the effects.

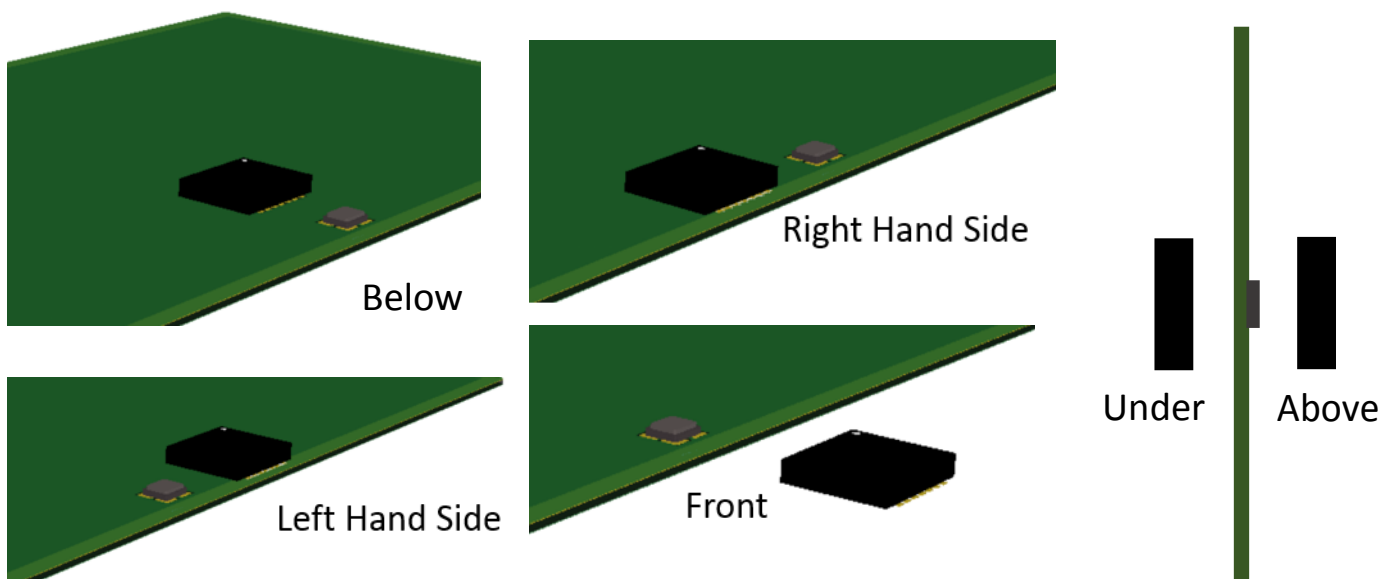

Figure 36. Component positions for clearance evaluation.

9.1 Return Loss and VSWR (Left-Hand Side vs Right-Hand Side)

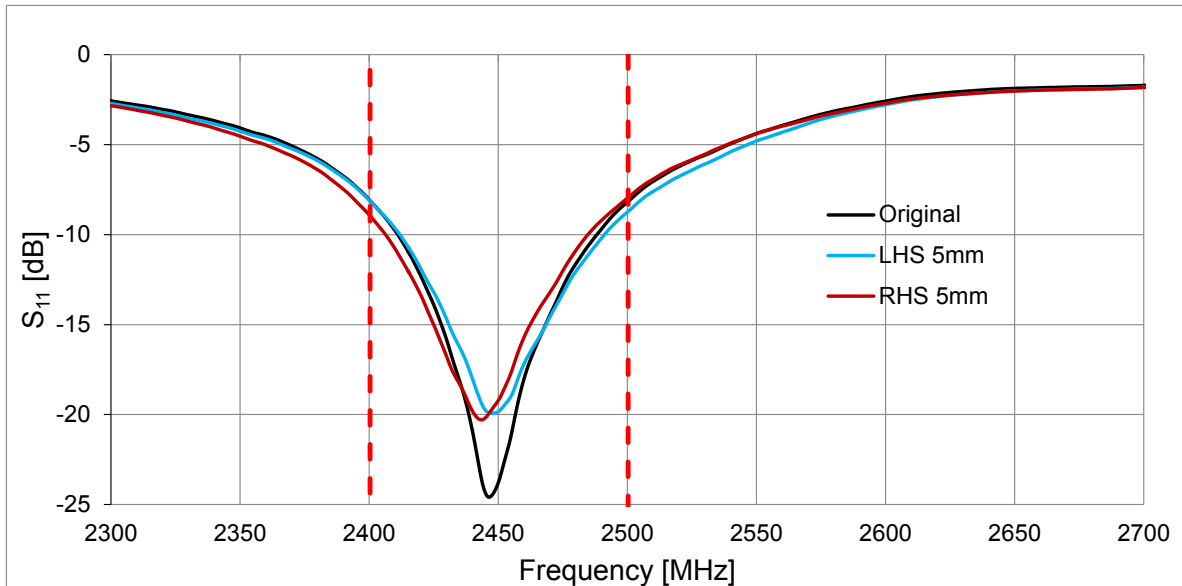

Figure 37. S_{11} plot for 2400-2500MHz band

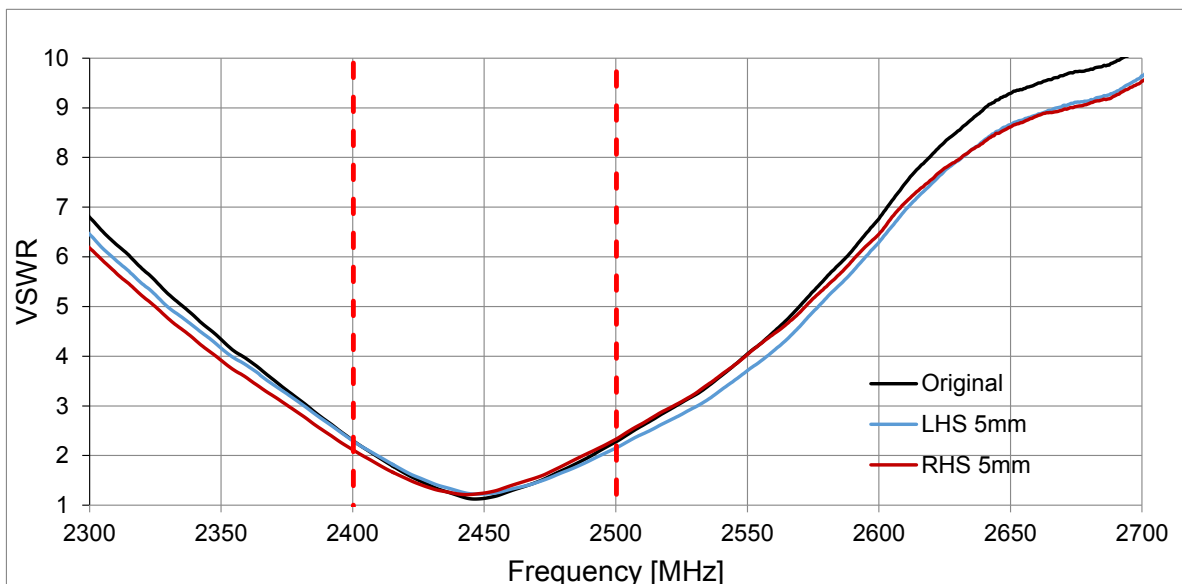

Figure 38. VSWR plot for 2400-2500MHz band

9.2 Efficiency, Peak Gain, Average Gain (Left-Hand Side vs Right-Hand Side)

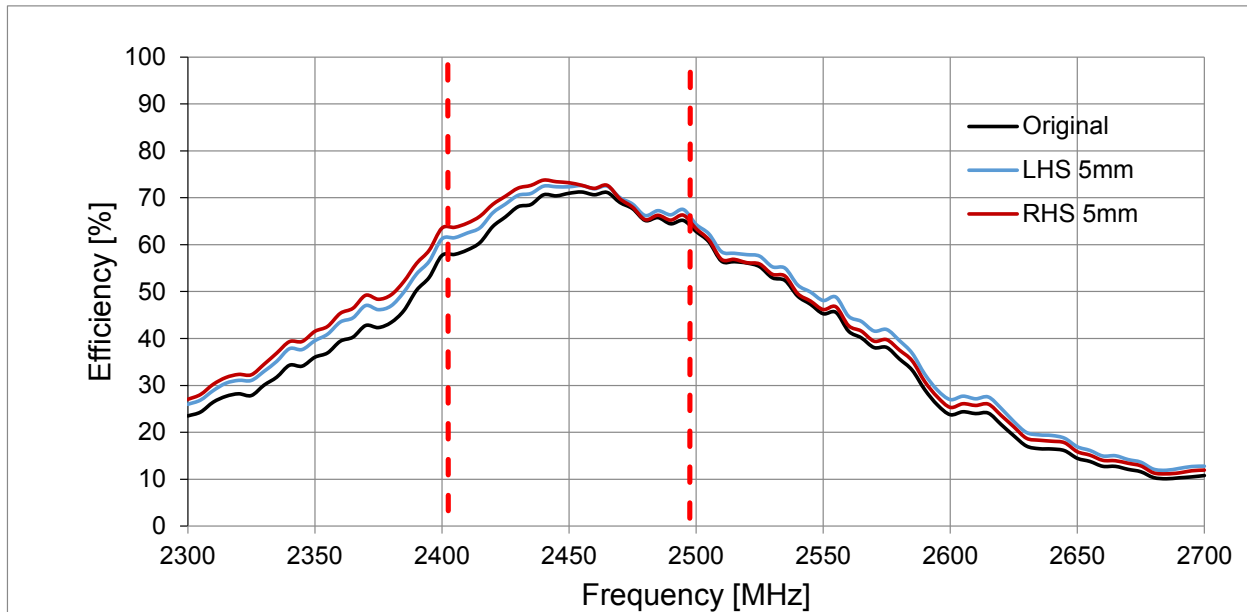

Figure 39. Efficiency plot for 2400-2500MHz band

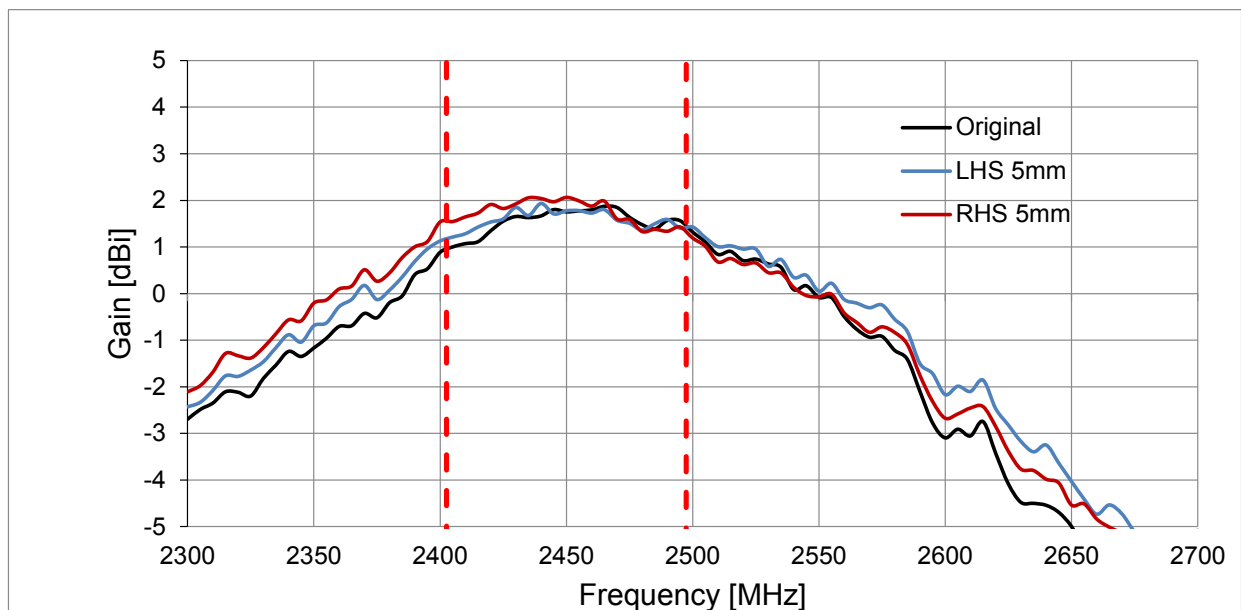

Figure 40. Peak Gain plot for 2400-2500MHz band

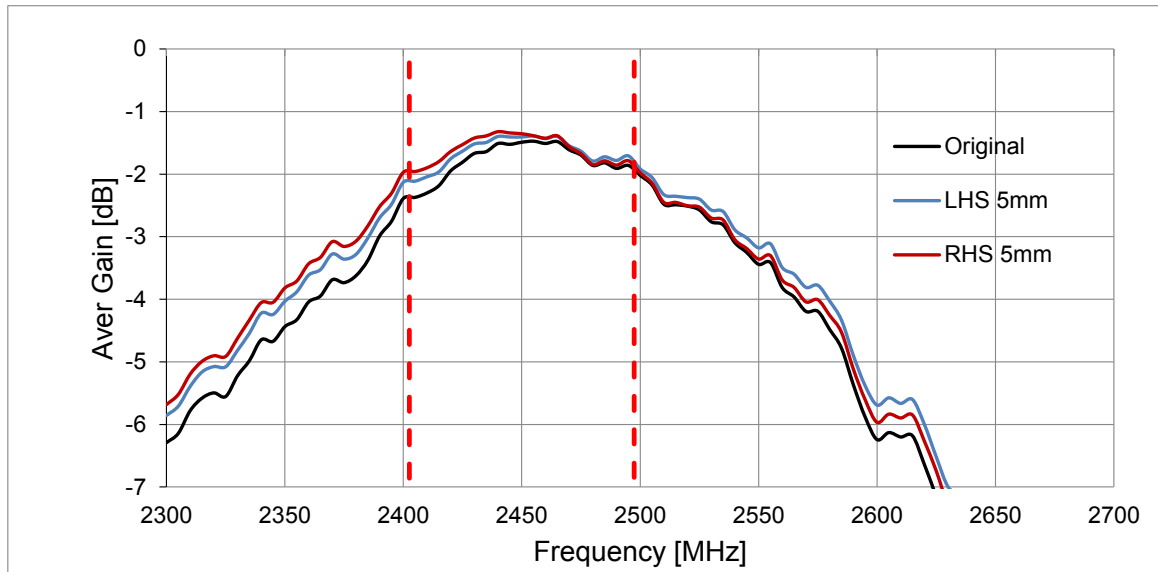

Figure 41. Average Gain plot for 2400-2500MHz band

There is no discernible difference in results from placing the object on the right-hand side or the left-hand side. It can therefore be taken that results for the left-hand side will be very similar to the component being placed on the right-hand side of the antenna.

9.3 Return Loss and VSWR (LHS 5mm, 10mm, 15mm, 20mm)

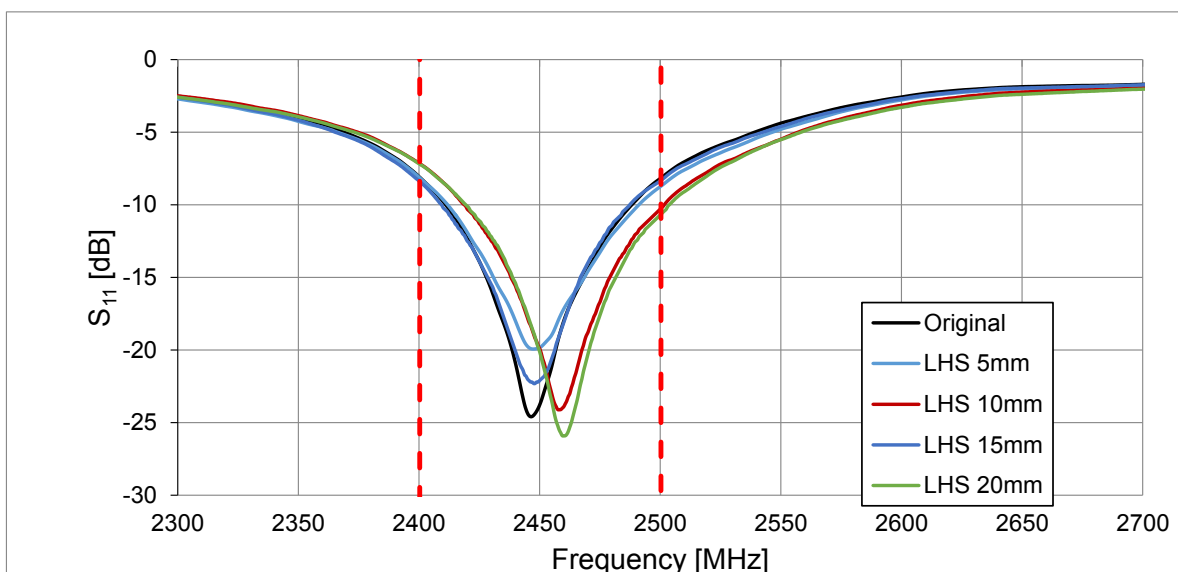

Figure 42. S_{11} plot for 2400-2500MHz band

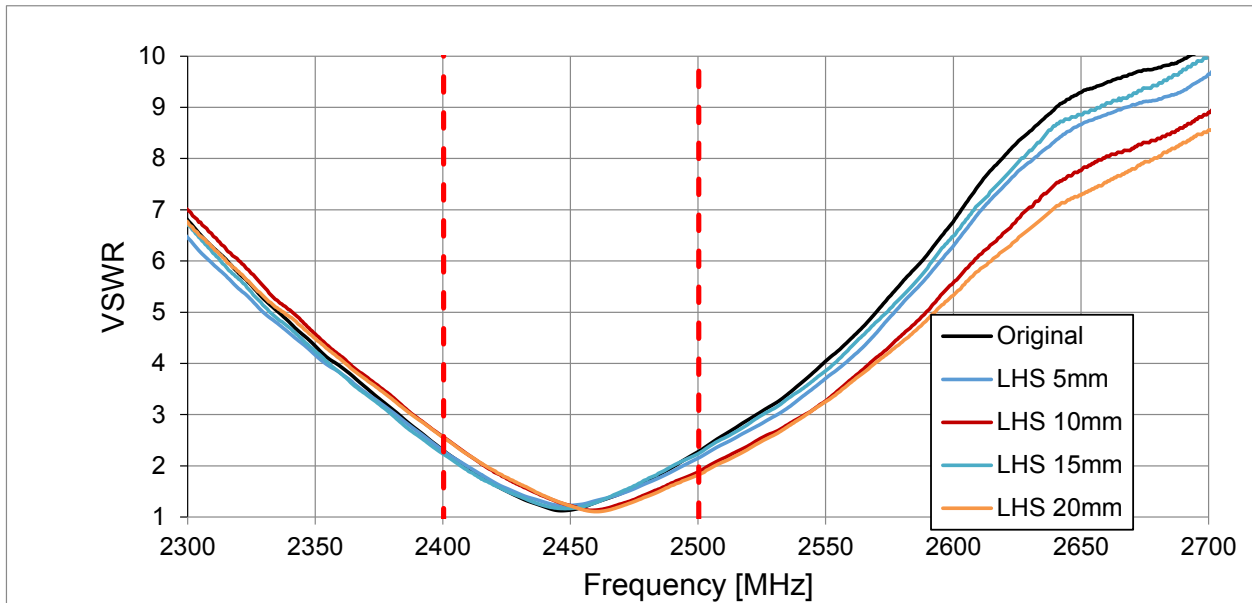

Figure 43. VSWR plot for 2400-2500MHz band

9.4 Efficiency, Peak Gain, Average Gain (LHS 5mm, 10mm, 15mm, 20mm)

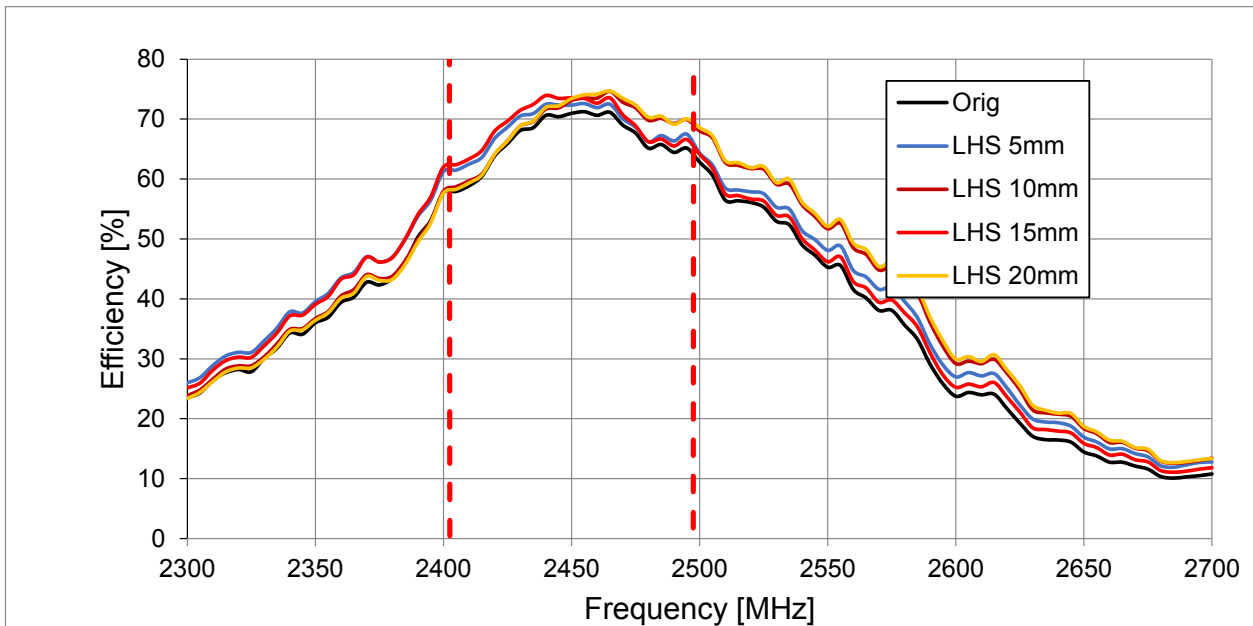

Figure 44. Efficiency plot for 2400-2500MHz band

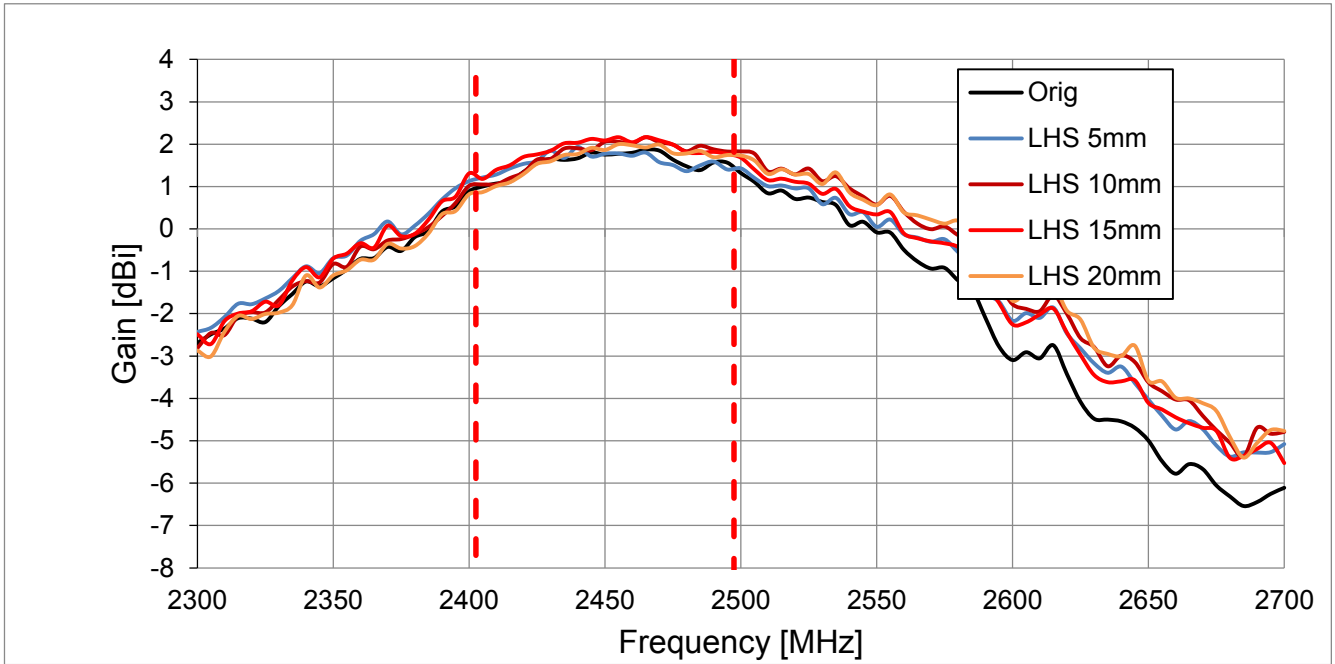

Figure 45. Peak Gain plot for 2400-2500MHz band

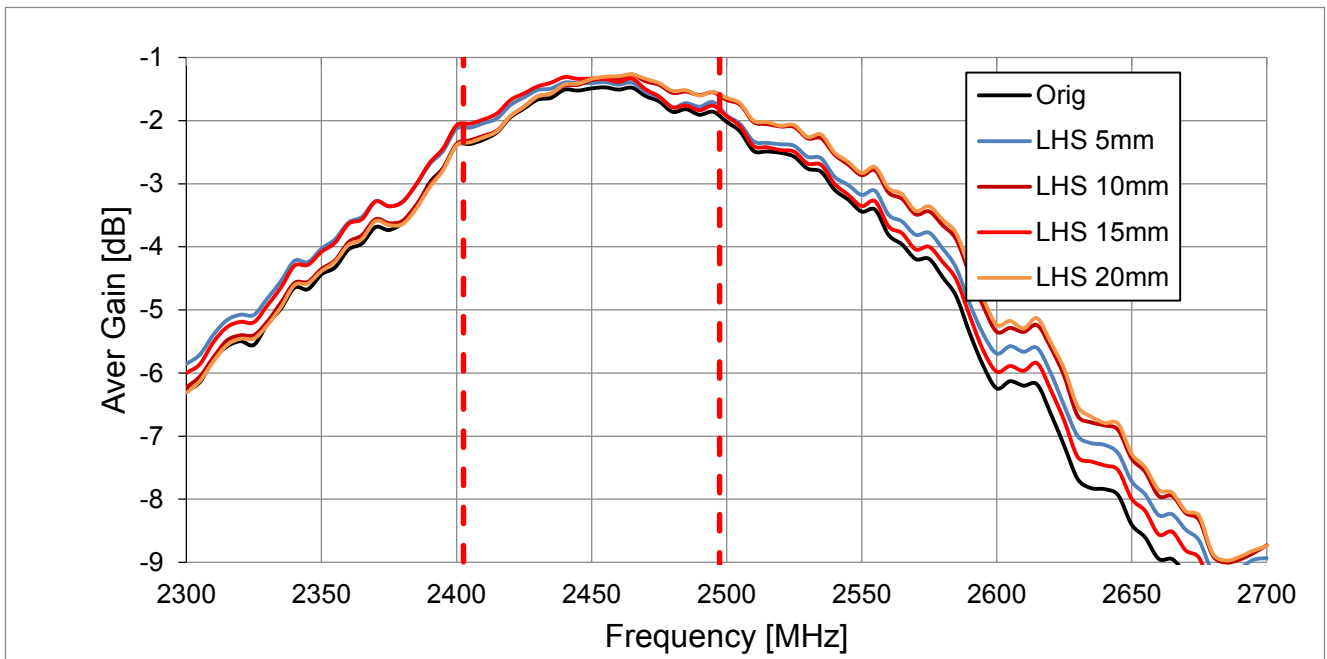

Figure 46. Average Gain plot for 2400-2500MHz band

9.5 Return Loss and VSWR (Above, Under, Front, Below)

Note: "Above-Under" refers to the result where a component is placed simultaneously above and under the WLA.01 antenna.

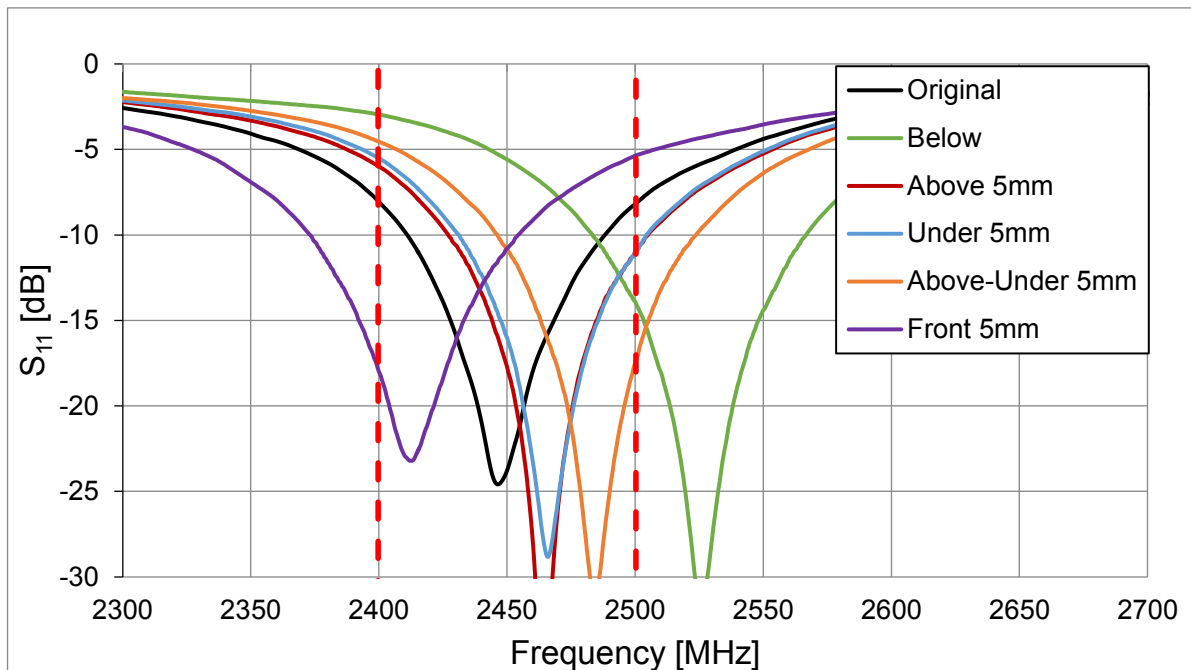

Figure 47. S_{11} plot for 2400-2500MHz band

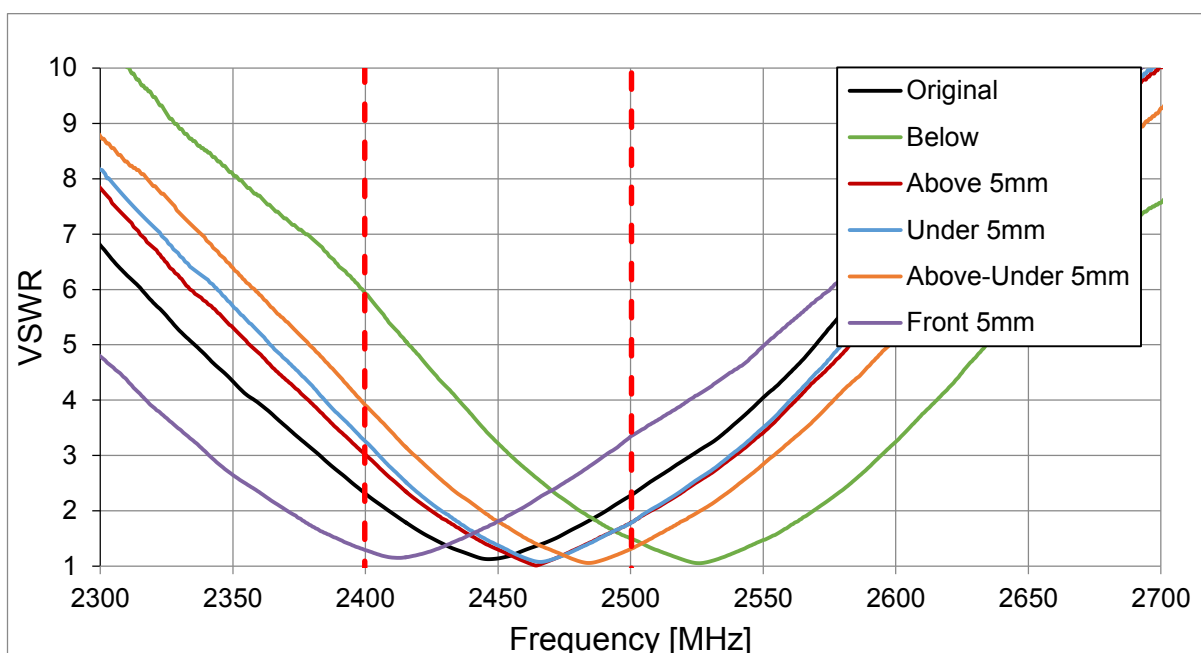

Figure 48. VSWR plot for 2400-2500MHz band

9.6 Efficiency, Peak Gain, Average Gain (Above, Under, Front, Below)

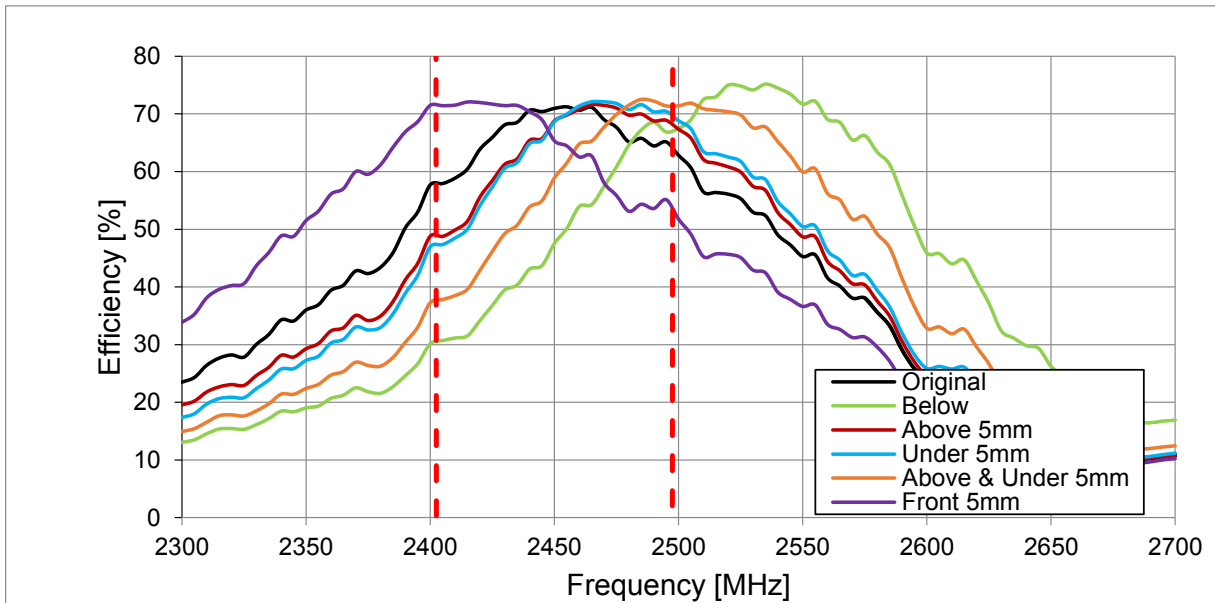

Figure 49. Efficiency plot for 2400-2500MHz band

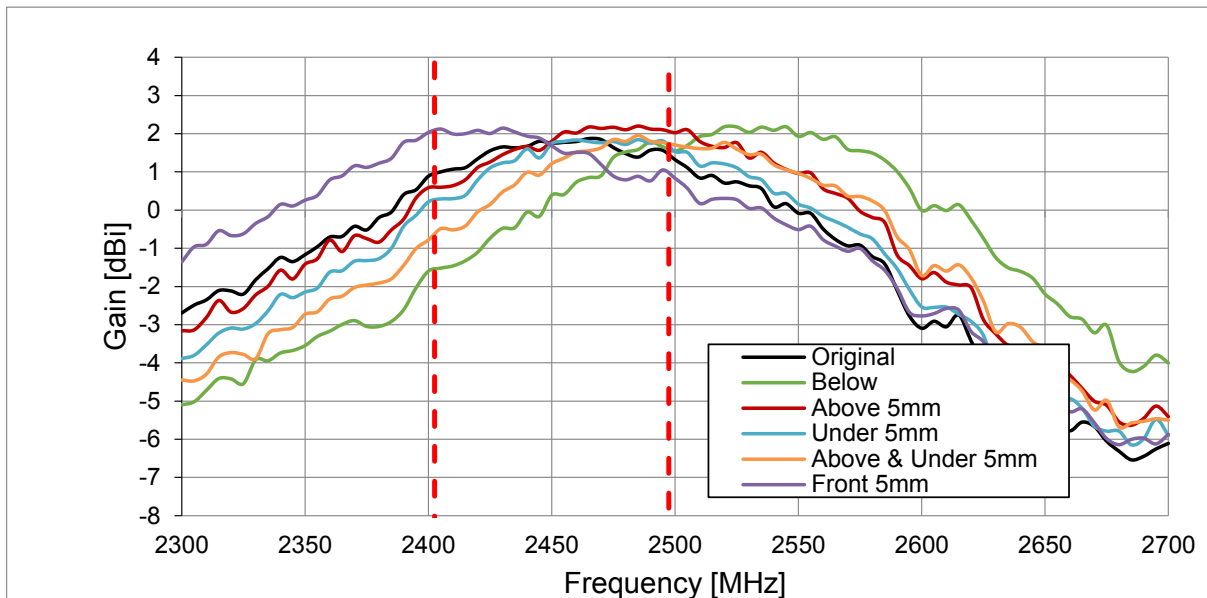

Figure 50. Peak Gain plot for 2400-2500MHz band

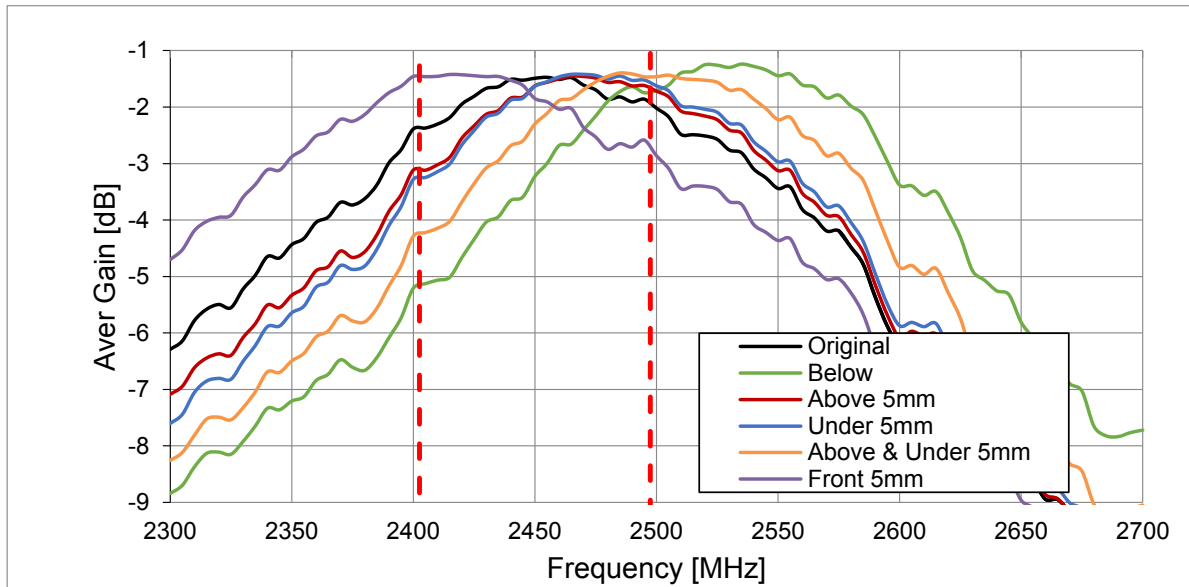

Figure 51. Average Gain plot for 2400-2500MHz band

9.7 Conclusion

The biggest effect of placing a module or metal component near the WLA.01 can be clearly seen when the object is placed in front or below. The WLA.01 becomes de-tuned and shifts resonance either above or below 2.45GHz by 50-75MHz.

The antenna can be re-tuned by changing the FTE component as described in the WLA.01 datasheet. The value on the evaluation board is 4.7pF. A lower value will shift the resonance to the right, consequently a higher value will shift to the left.

10 Effect above Ground Plane

The influence of the WLA.01 situated above a ground plane was studied next. The following scenarios are considered:

WLAD.01 positioned above centre of 300*300mm ground plane.

WLAD.01 positioned above edge of 300*300mm ground plane.

WLAD.01 positioned above centre of 150*90mm ground plane.

WLAD.01 positioned above edge of 150*90mm ground plane.

The study was to find the minimum height above each ground plane that achieved 20% efficiency and also determine whether the size of the ground plane underneath the evaluation board has an impact.

10.1 WLAD.01 positioned above centre of 300*300mm ground plane

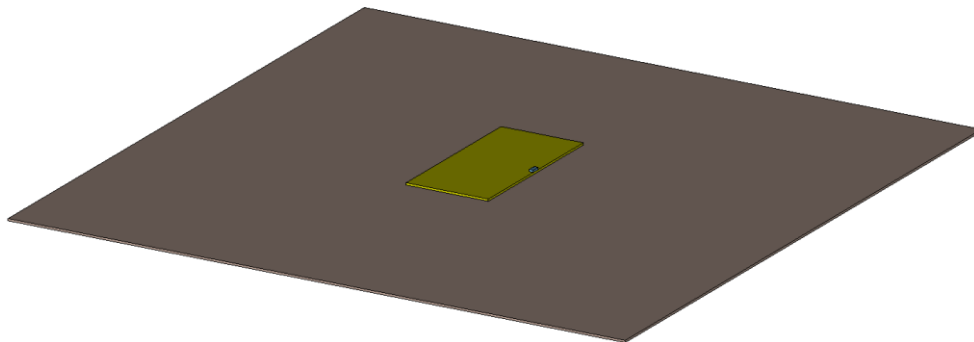

10.1.1 Return Loss and VSWR

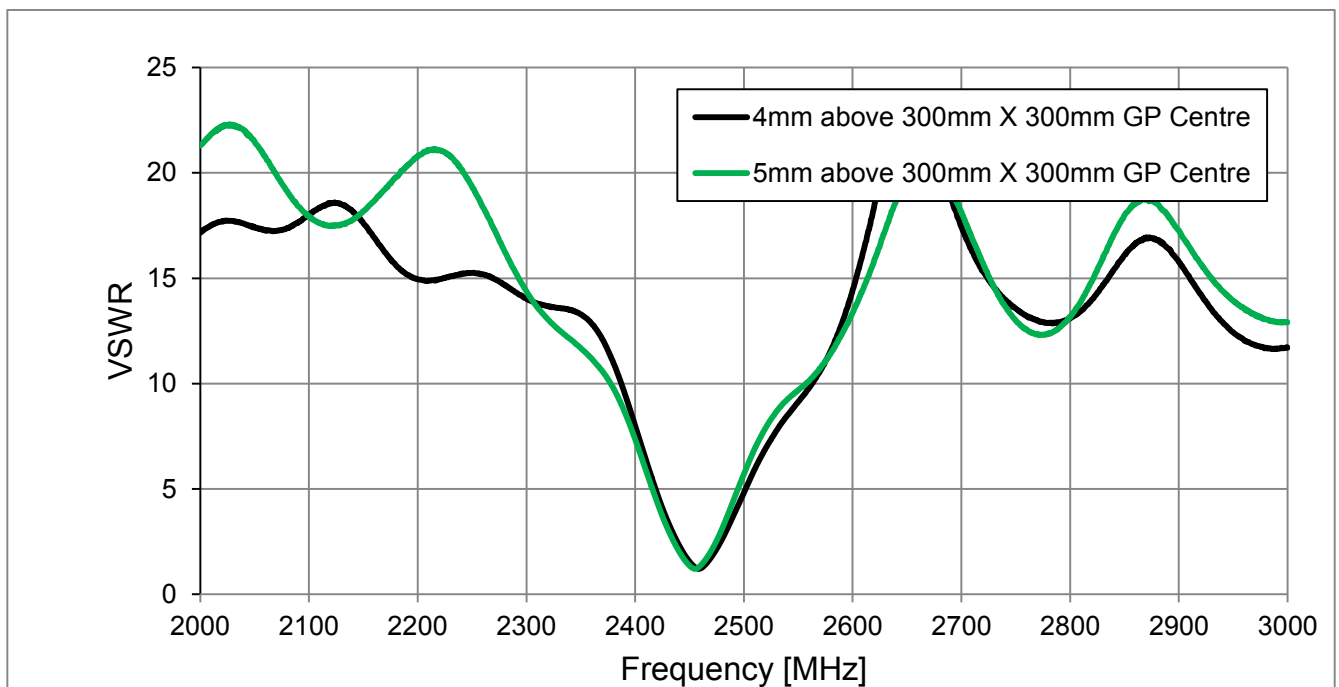
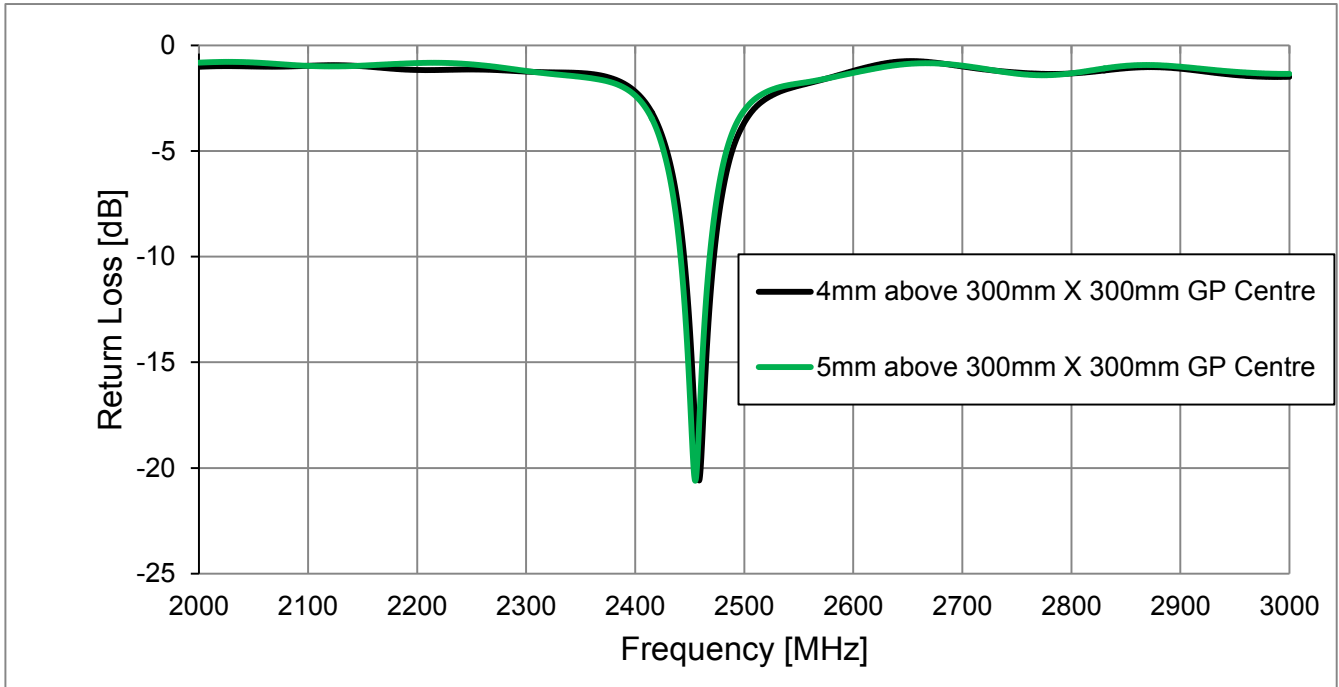

10.1.2 Efficiency, Peak Gain & Average Gain

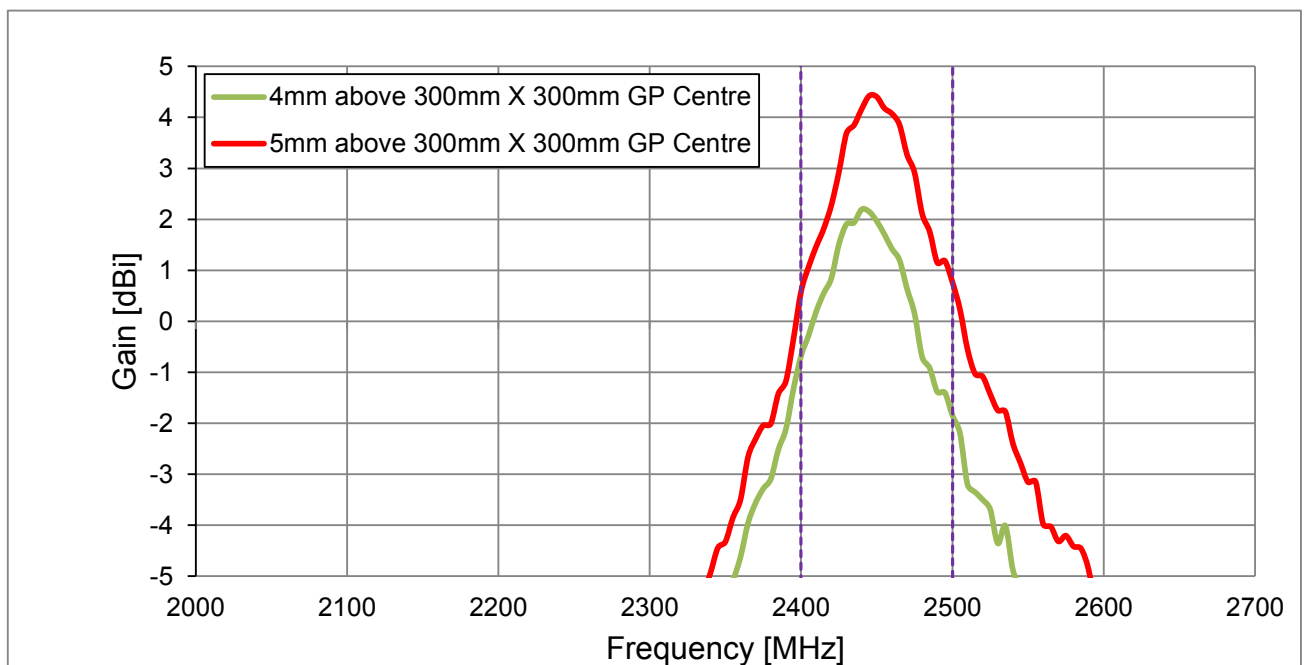
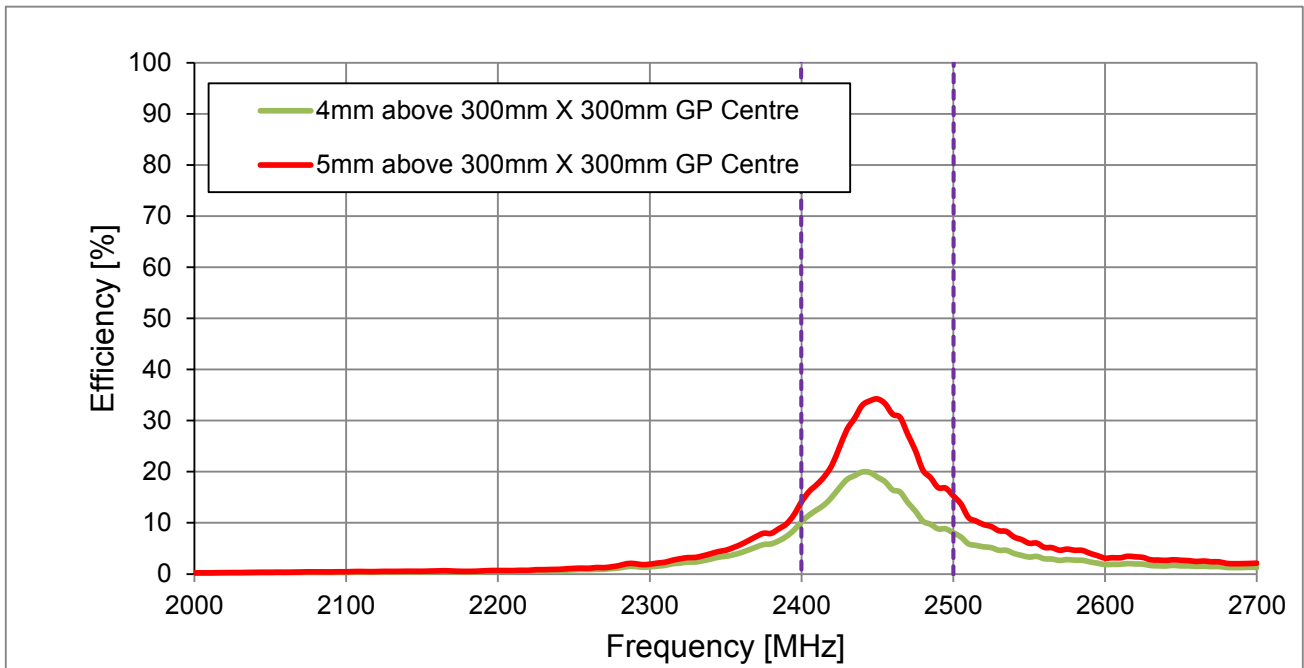

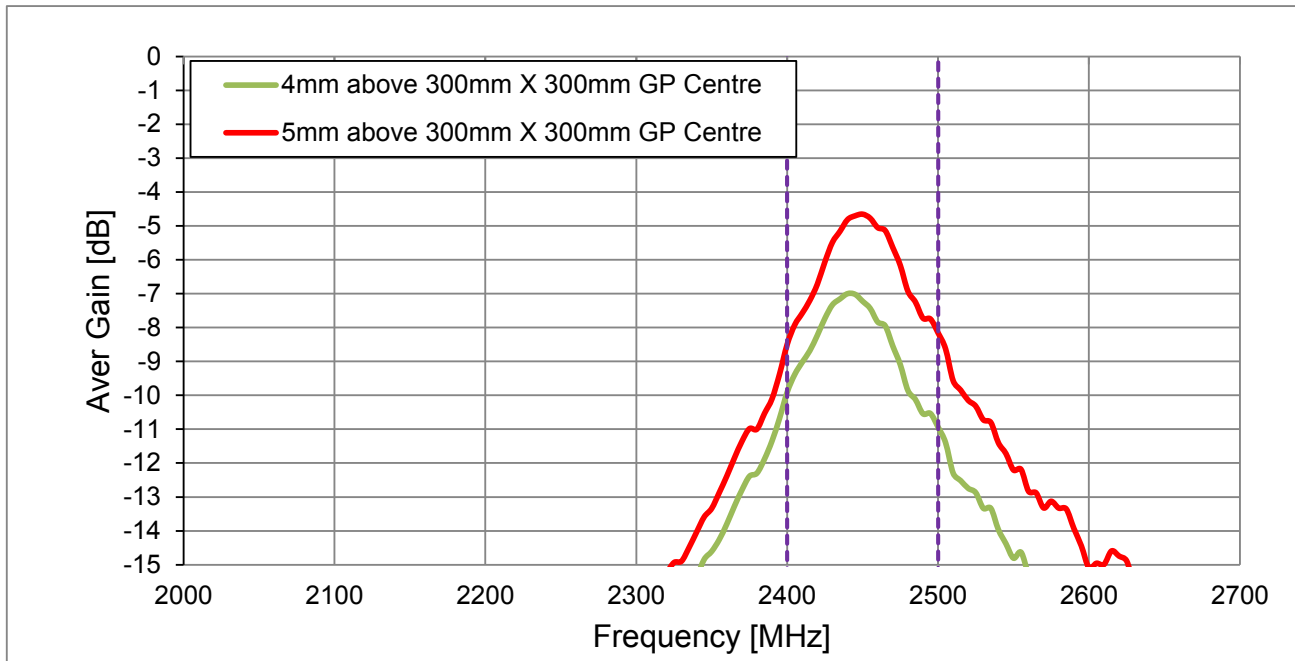

For the 4mm above 300*300mm ground plane center the antenna matching circuitry was modified as follows: FTE=10pF, S2 = 4.7nH, S1 = 1.5pF

For the 5mm above 300*300mm ground plane center the antenna matching circuitry was modified as follows: FTE = 6pF, S2 = 4.7nH, S1 = 1.5pF

10.2 WLAD.01 positioned above edge of 300*300mm ground plane

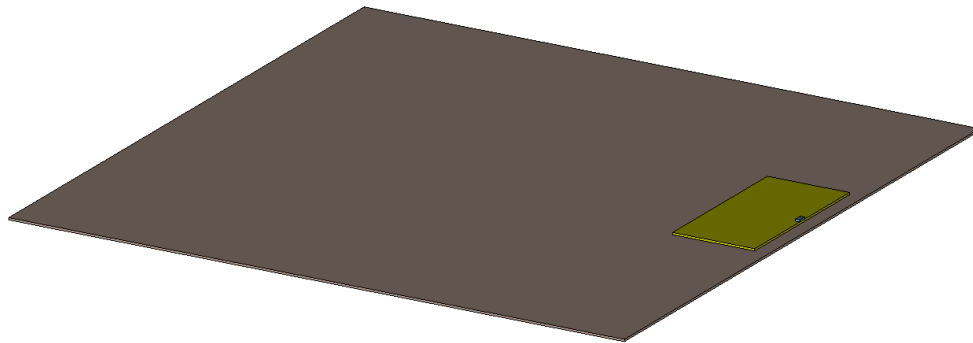

10.2.1 Return Loss and VSWR

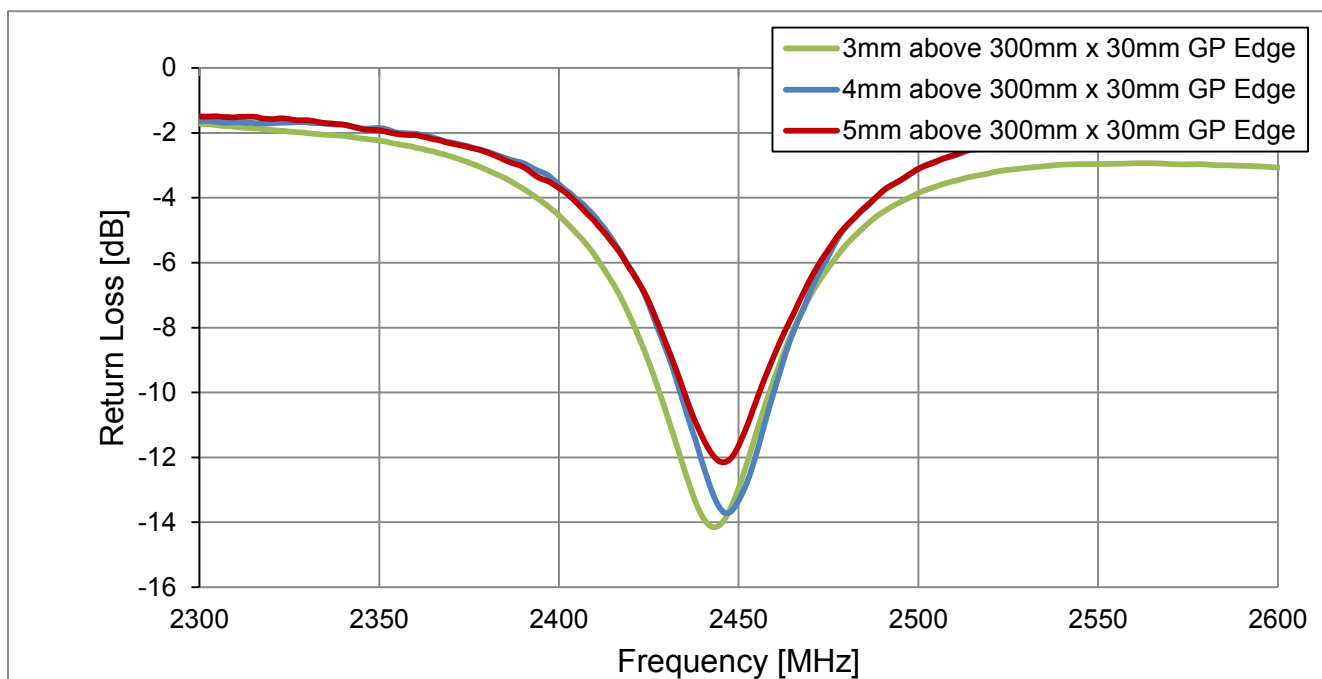

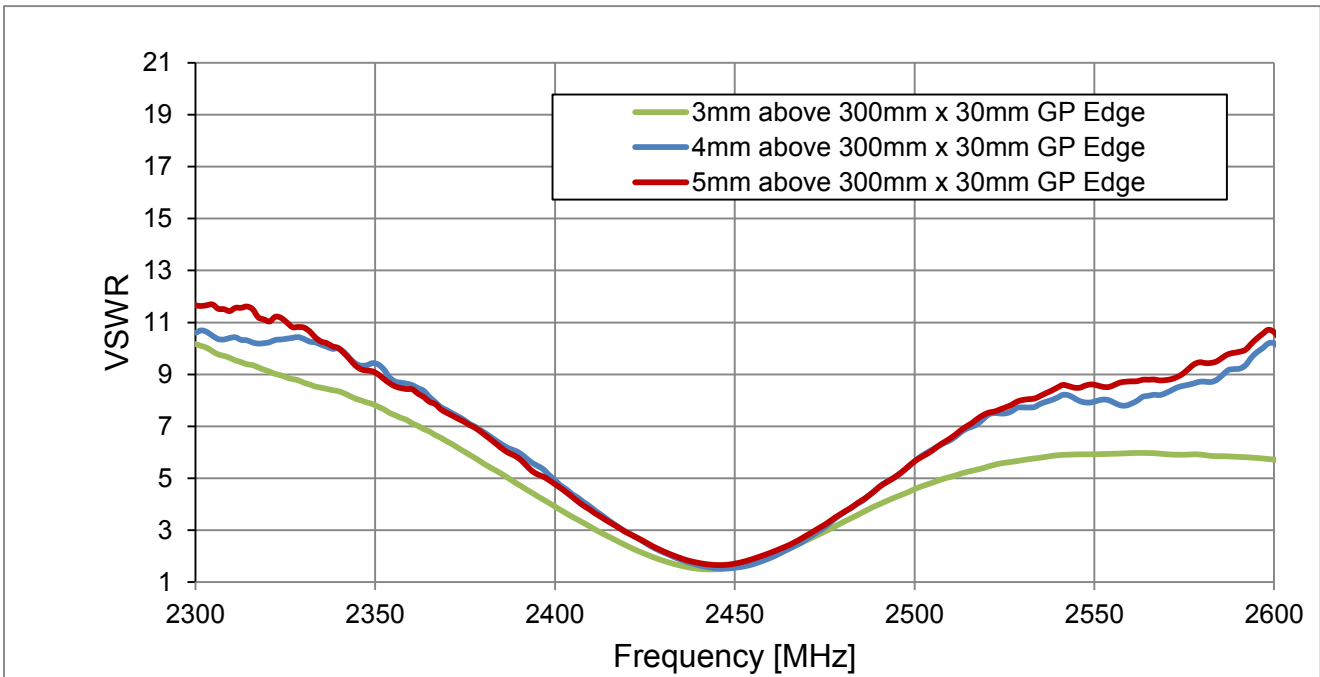

10.2.2 Efficiency

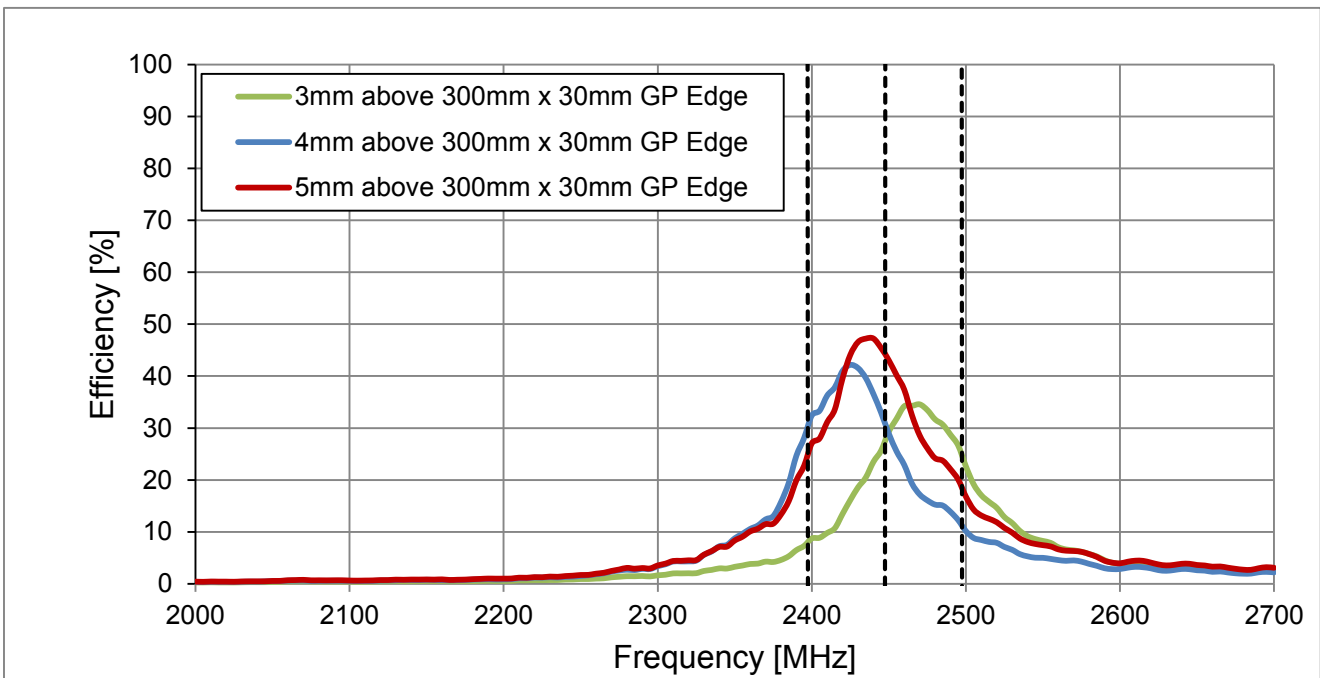

10.2.3 Peak Gain

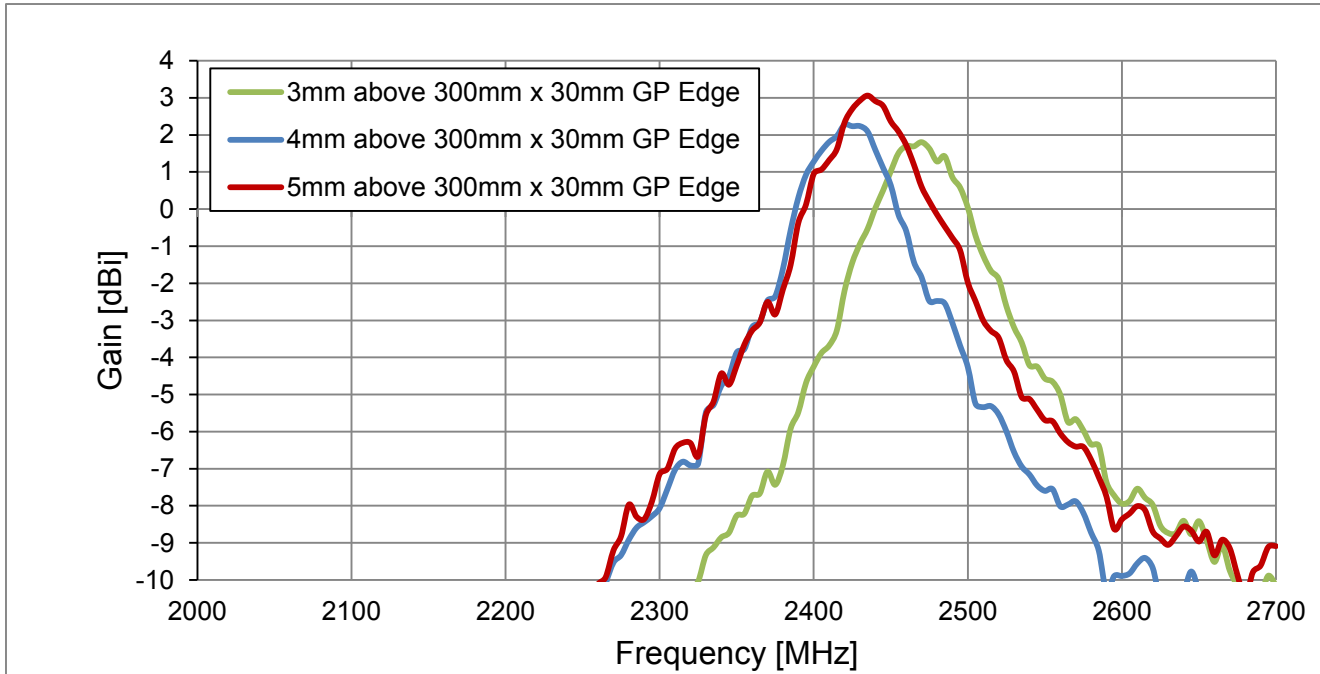

10.2.4 Average Gain

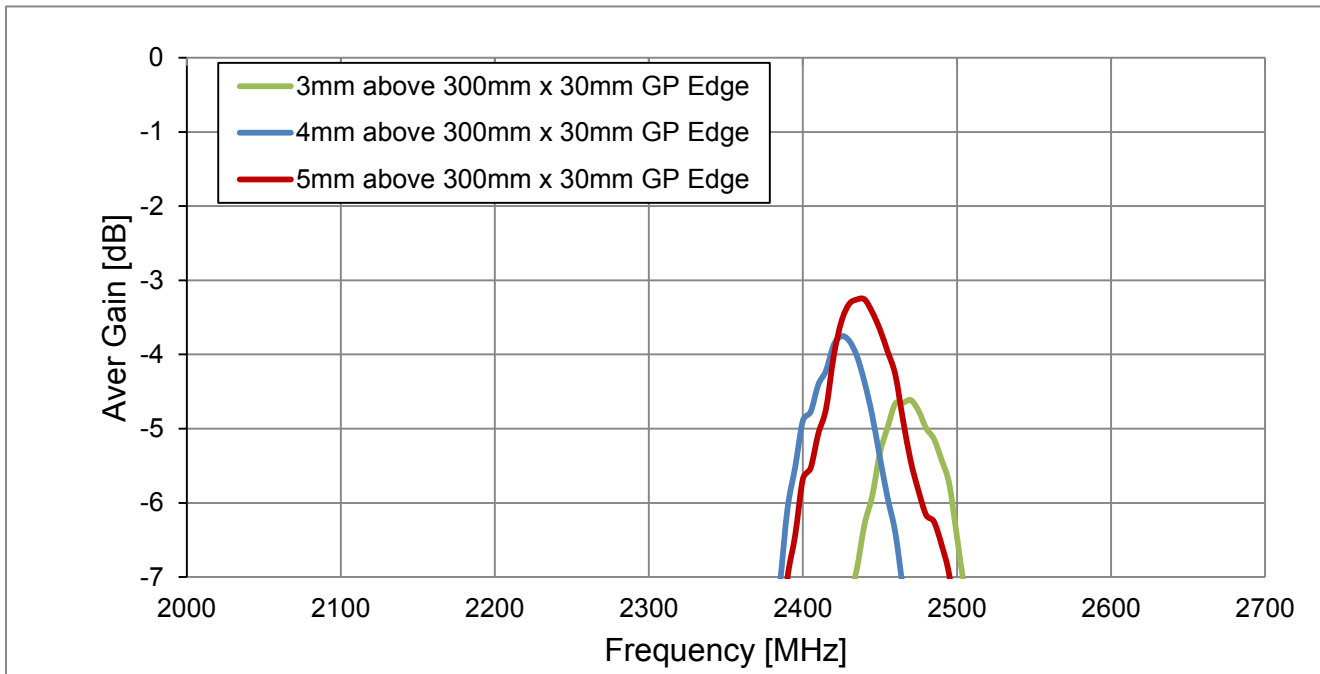

For the 3mm above 300*300mm ground plane edge the antenna matching circuitry was modified as follows: FTE=39pF, S2 = 4.7nH, S1 = 2.5pF

For the 4mm above 300*300mm ground plane edge the antenna matching circuitry was modified as follows: FTE=15pF, S2 = 4.7nH, S1 = 2.5pF

For the 5mm above 300*300mm ground plane edge the antenna matching circuitry was modified as follows: FTE = 5pF, S2 = 4.7nH, S1 = 2.5pF

10.3 WLAD.01 positioned above centre 150*90mm ground plane

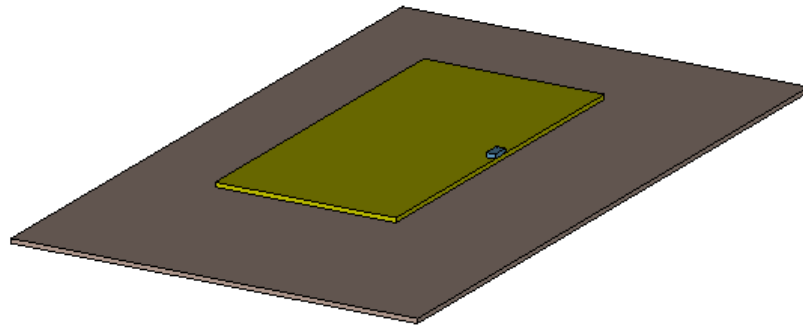

10.3.1 Return Loss and VSWR

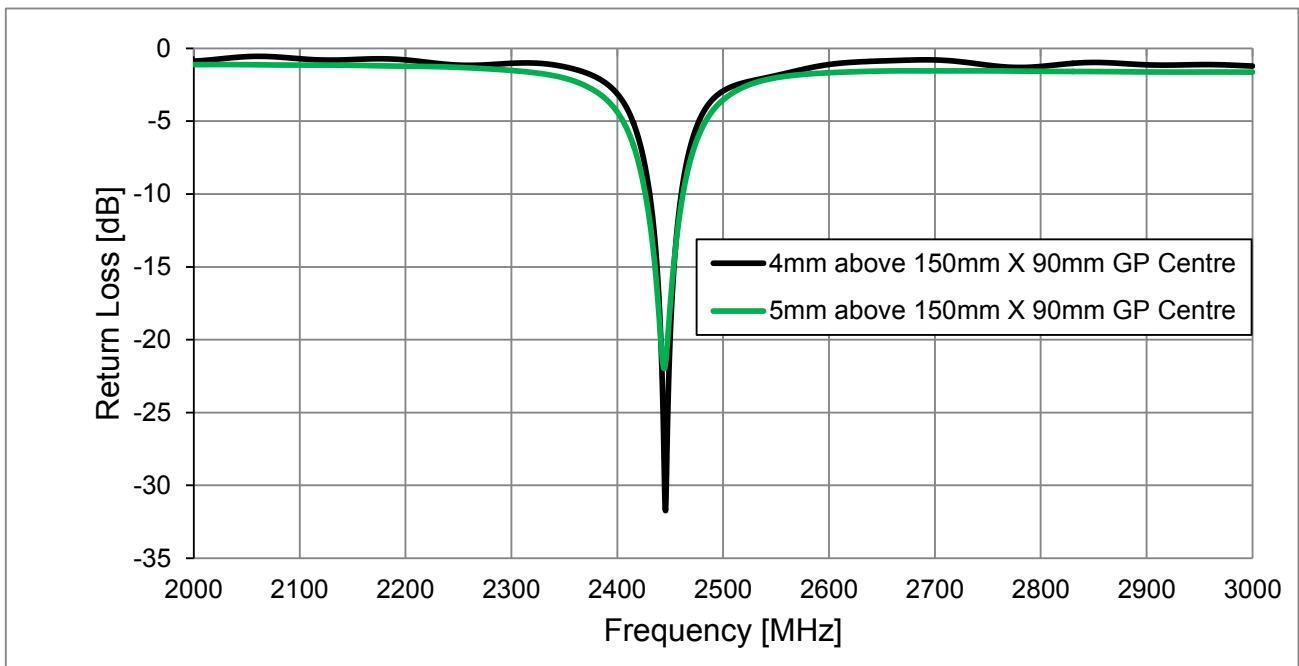

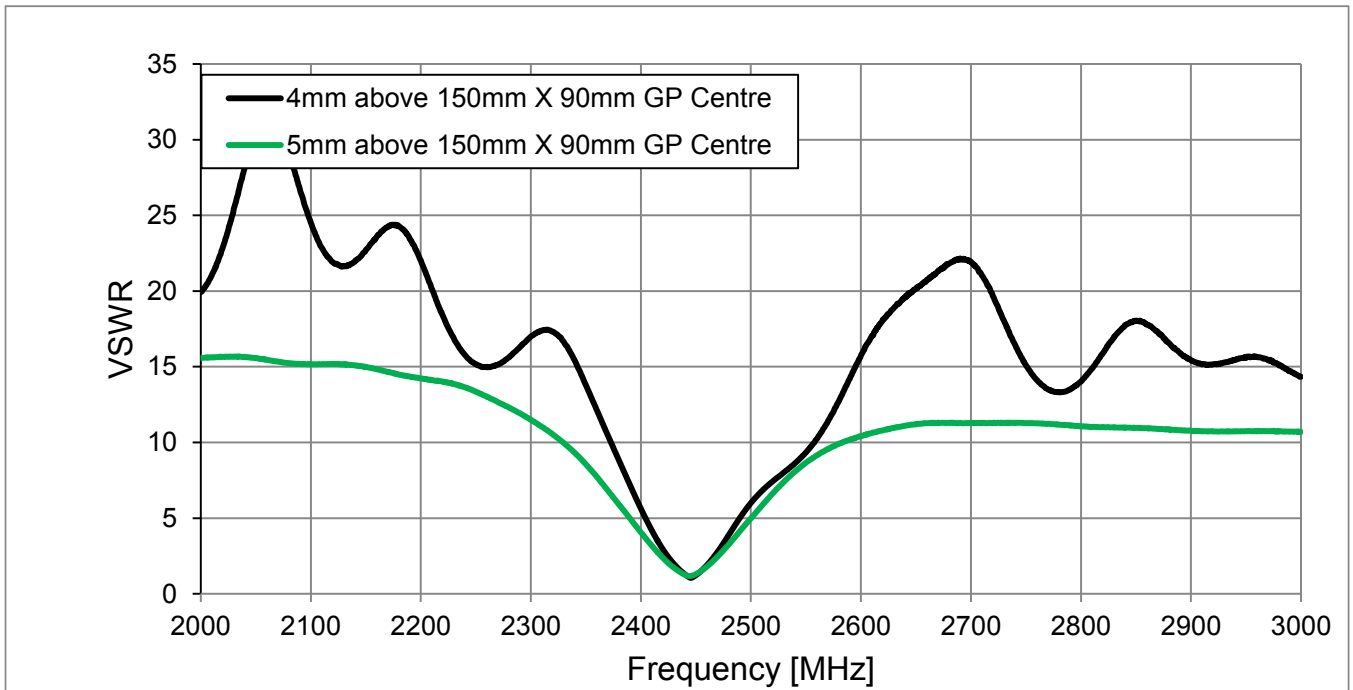

10.3.2 Efficiency

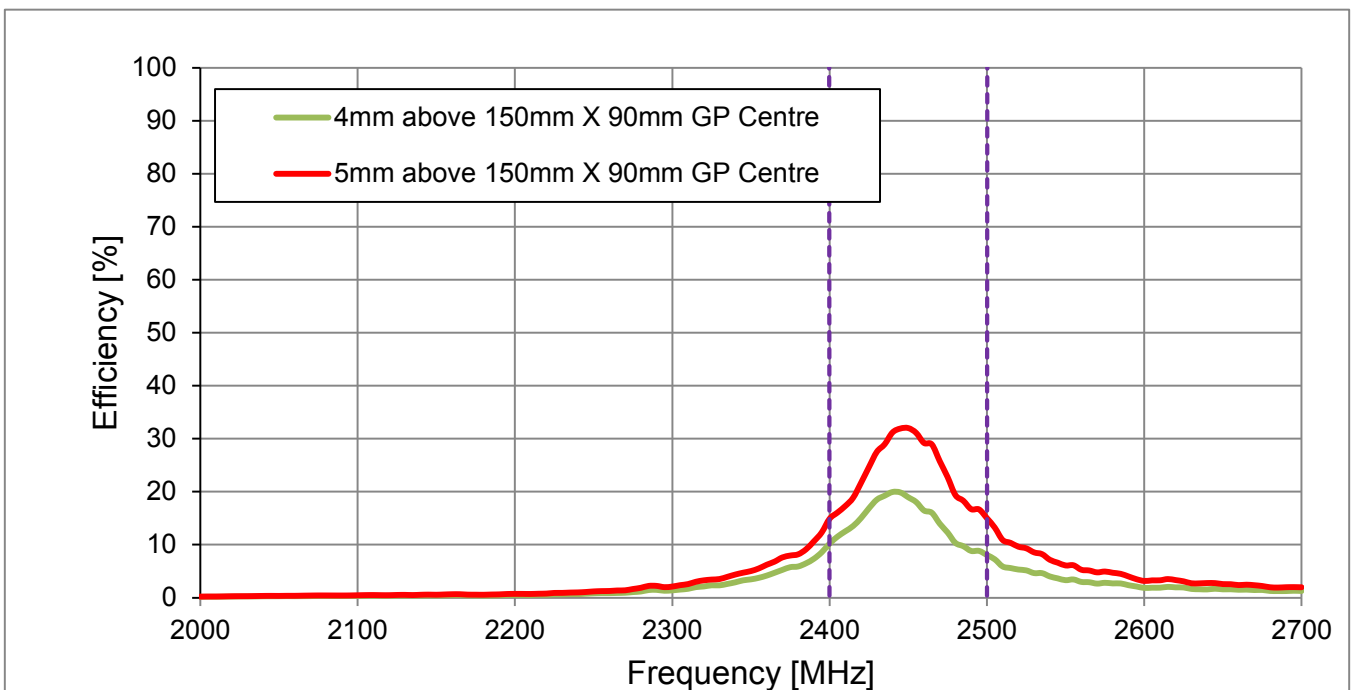

10.3.3 Peak Gain

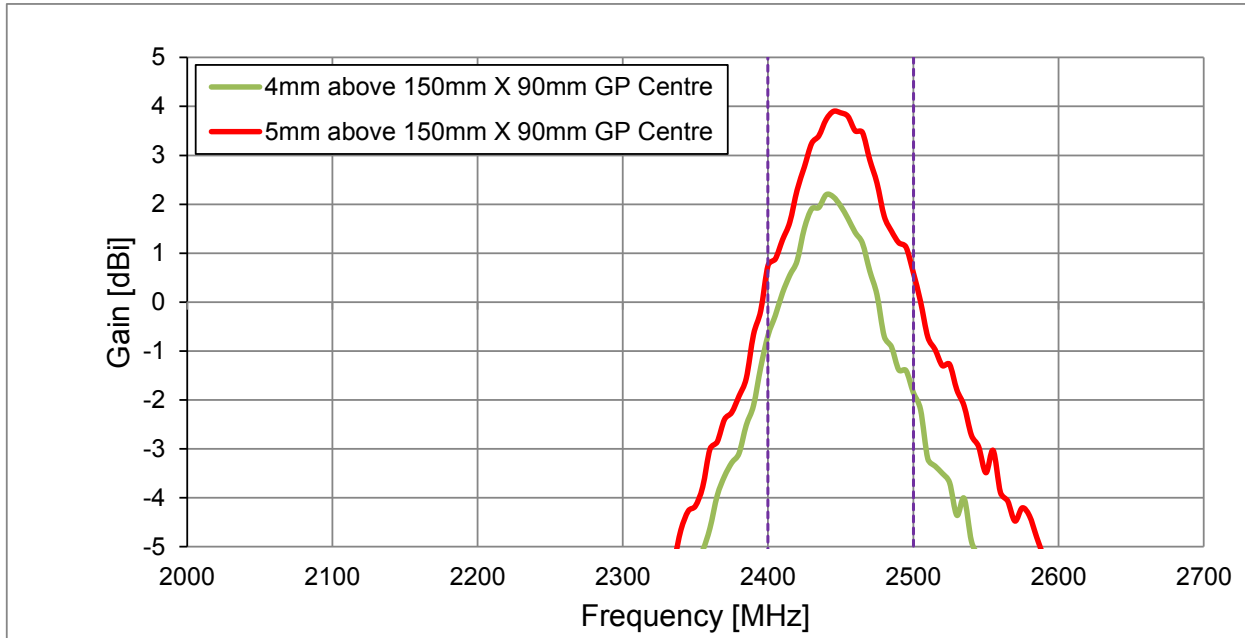

10.3.4 Average Gain

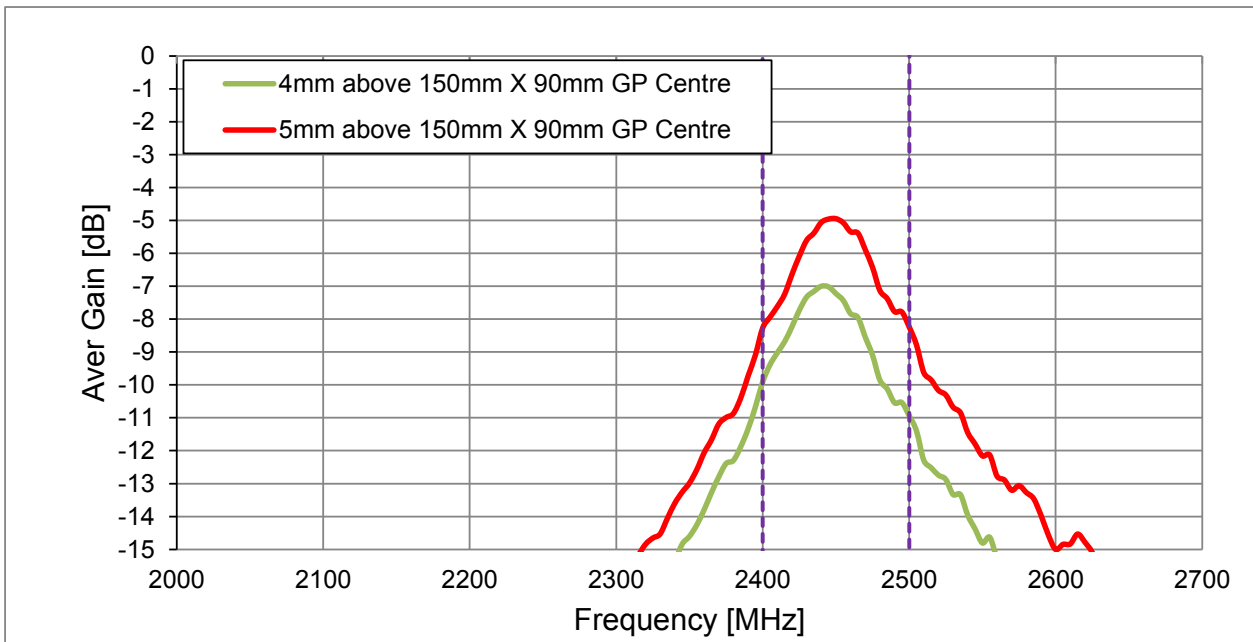

For the 4mm above 150*90mm ground plane center the antenna matching circuitry was modified as follows: FTE=10pF, S2 = 4.7nH, S1 = 1.5pF

For the 5mm above 150*90mm ground plane center the antenna matching circuitry was modified as follows: FTE = 6pF, S2 = 4.7nH, S1 = 1.5pF

10.4 WLAD.01 positioned above edge of 150mm x 90mm ground plane

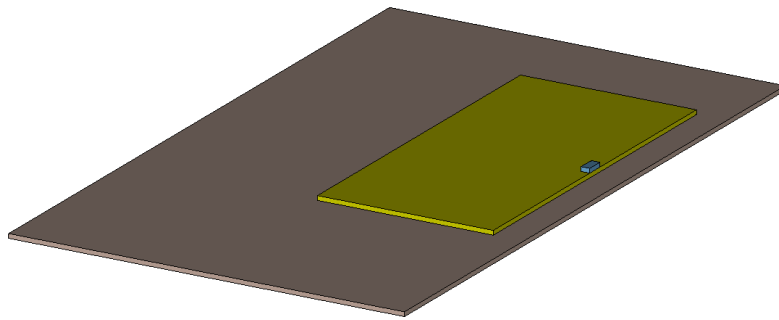

10.4.1 Return Loss and VSWR

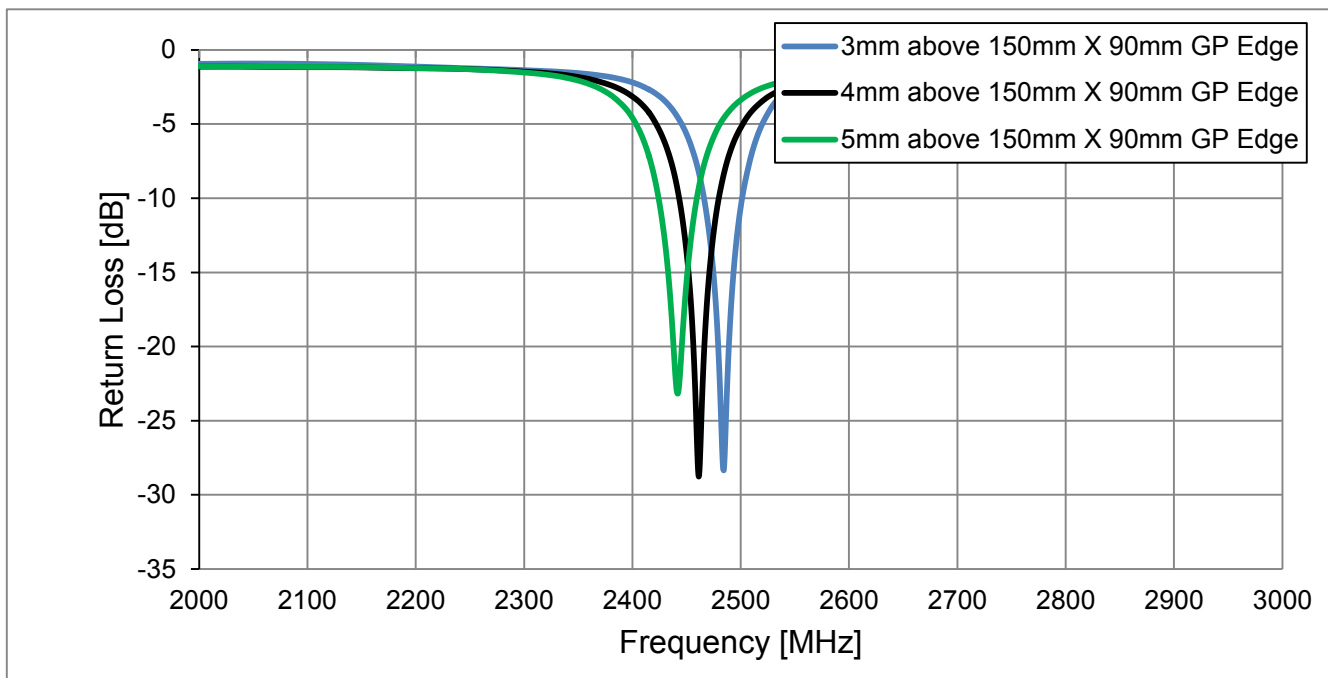

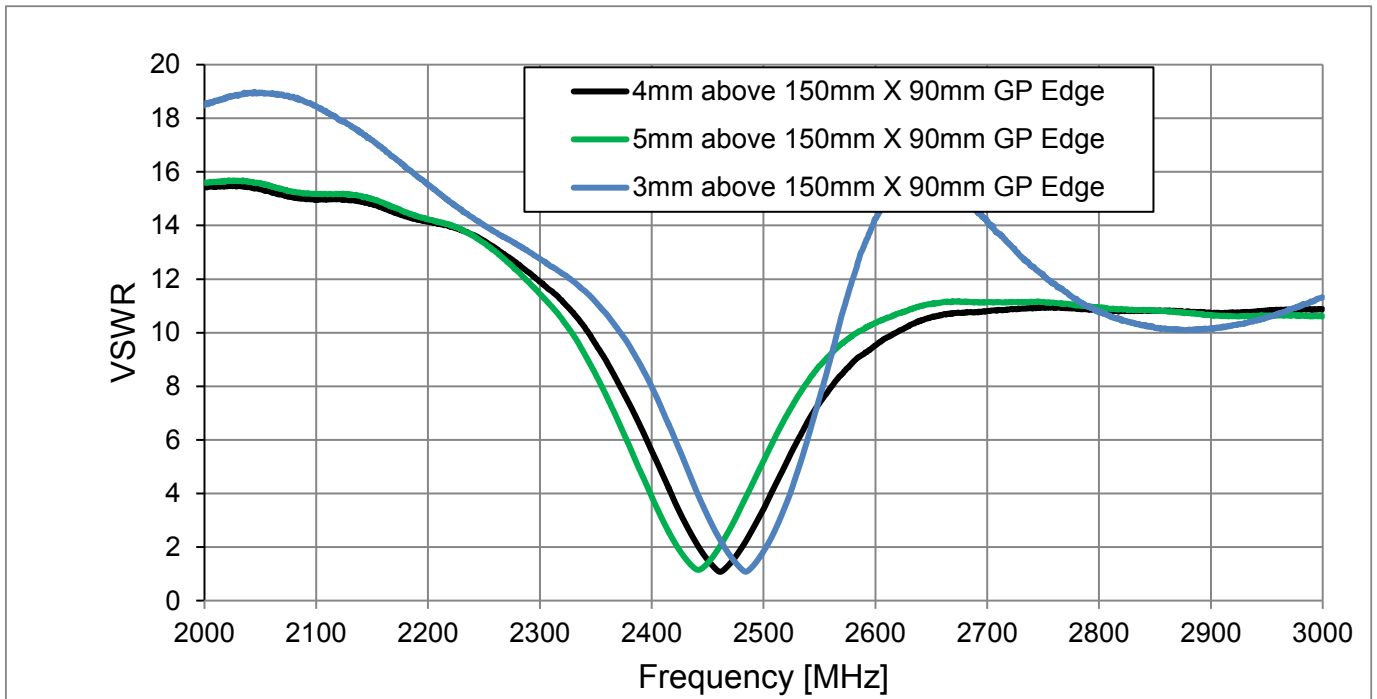

10.4.2 Efficiency

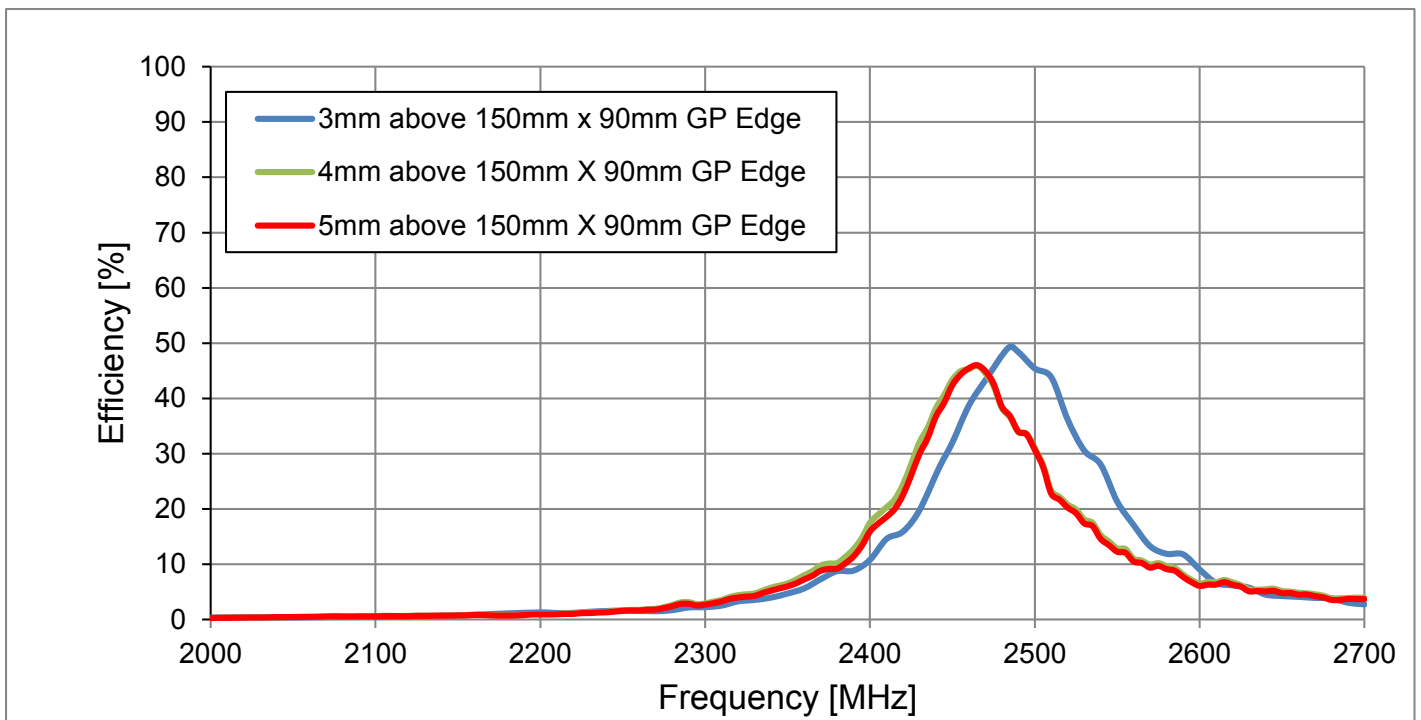

10.4.3 Peak Gain

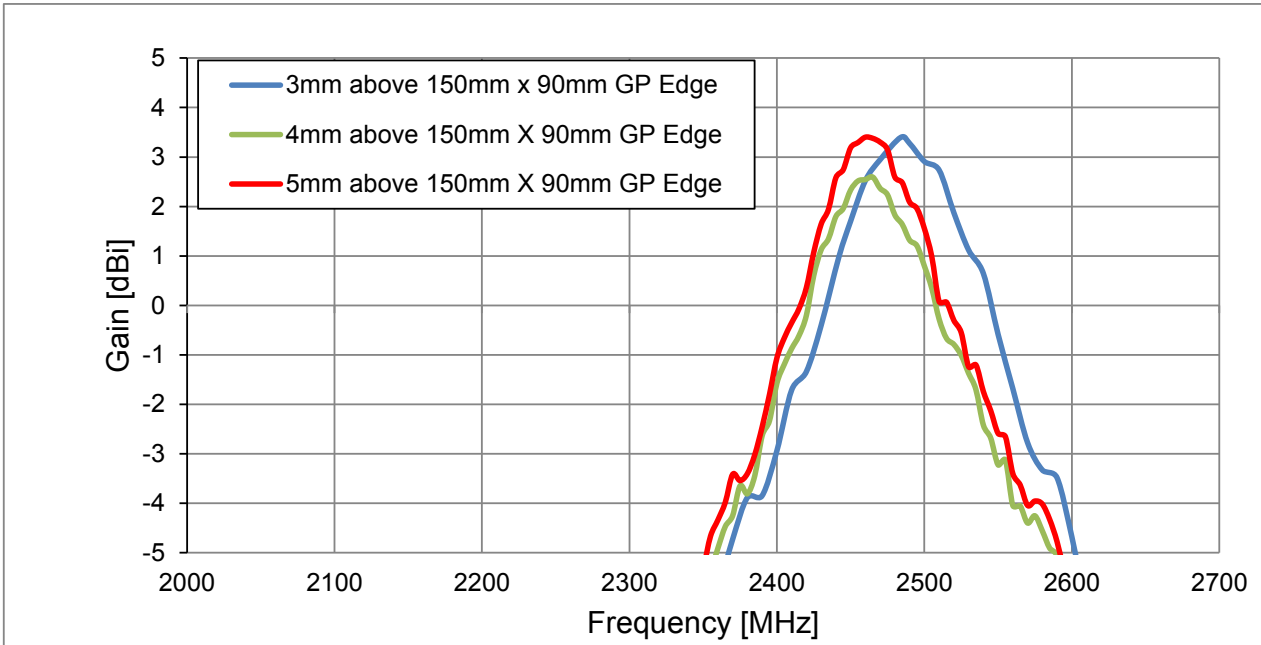

10.4.4 Average Gain

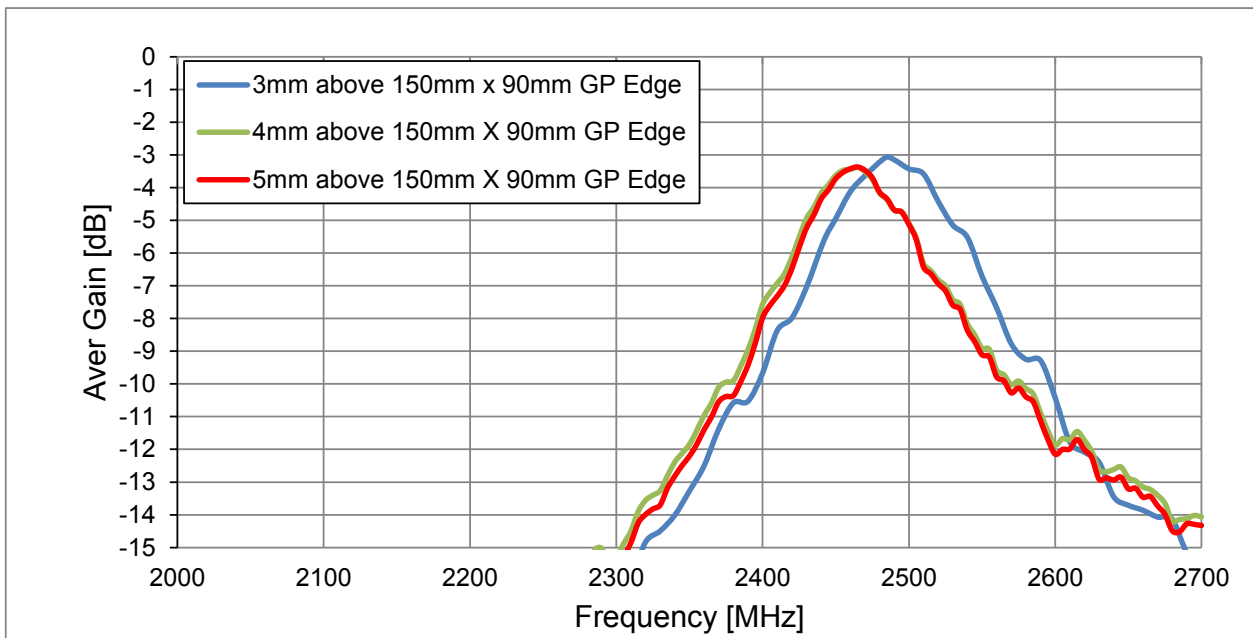

For the 3mm above 150*90mm ground plane edge the antenna matching circuitry was modified as follows: FTE=15pF, S2 = 4.7nH, S1 = 1.5pF

For the 4mm above 150*90mm ground plane edge the antenna matching circuitry was modified as follows: FTE=10pF, S2 = 4.7nH, S1 = 1.5pF

For the 5mm above 150*90mm ground plane edge the antenna matching circuitry was modified as follows: FTE = 6pF, S2 = 4.7nH, S1 = 1.5pF

10.5 Conclusion

The two scenarios where the WLAD.01 is positioned above a 300*300mm Ground Plane Centre and a 150*90mm Ground Plane Centre have very similar results. 4mm clearance is the minimum distance to the ground plane for 20% efficiency. This efficiency falls to 10% on either side of the bands.

For the other two scenarios where the WLAD.01 is positioned above a 300mm x 300 Ground Plane Edge and a 150*90mm Ground Plane Edge have also similar results. Efficiency did not drop to 20% when brought closer to the ground plane. Efficiency dropped from 48% to 35% between 5mm and 3mm respectively for the 300*300mm Ground Plane.

The efficiency when placed above a 150*90mm Ground Plane Edge remains in the 40% - 50% band.

It was found that when the WLAD.01 is placed above the centre of a Ground Plane, the efficiency drops, whereas the effect of placing the WLAD.01 above the edge of a ground plane causes the frequency to shift right.

This shift to the right necessitates the use of a large (39pF) capacitor to bring it back within the bands. Higher FTE component values had no effect on this tuning.

Therefore when placing the WLAD.01 above the edge of a ground plane the minimum distance is 3mm as bringing it closer causes the centre frequency to shift too far that it cannot be brought back within the 2.4GHz – 2.5GHz bands.