

PCN – Process Change Notification

Change:	CAB.S02
Date:	2017/08/30
Author	Haley Tsai

Affected Products

Model#	Part Number	Changes
IpexMHF4(HSC comp) to SMA(F)BK Jack Straight -0.81mm coax cable-200mm	CAB.S02	1. Amend Package Rule.

Type of Change

- Hardware Modification
 Production Process Advance
 Others –Amend Package Rule.
-

Description of Change

1. Amend Package Rule.

Schedule

2017, August, Taoglas will provide new package rule into production.

Forecast Estimated Transition Date

August/2017

Illustration of Change

Old Package

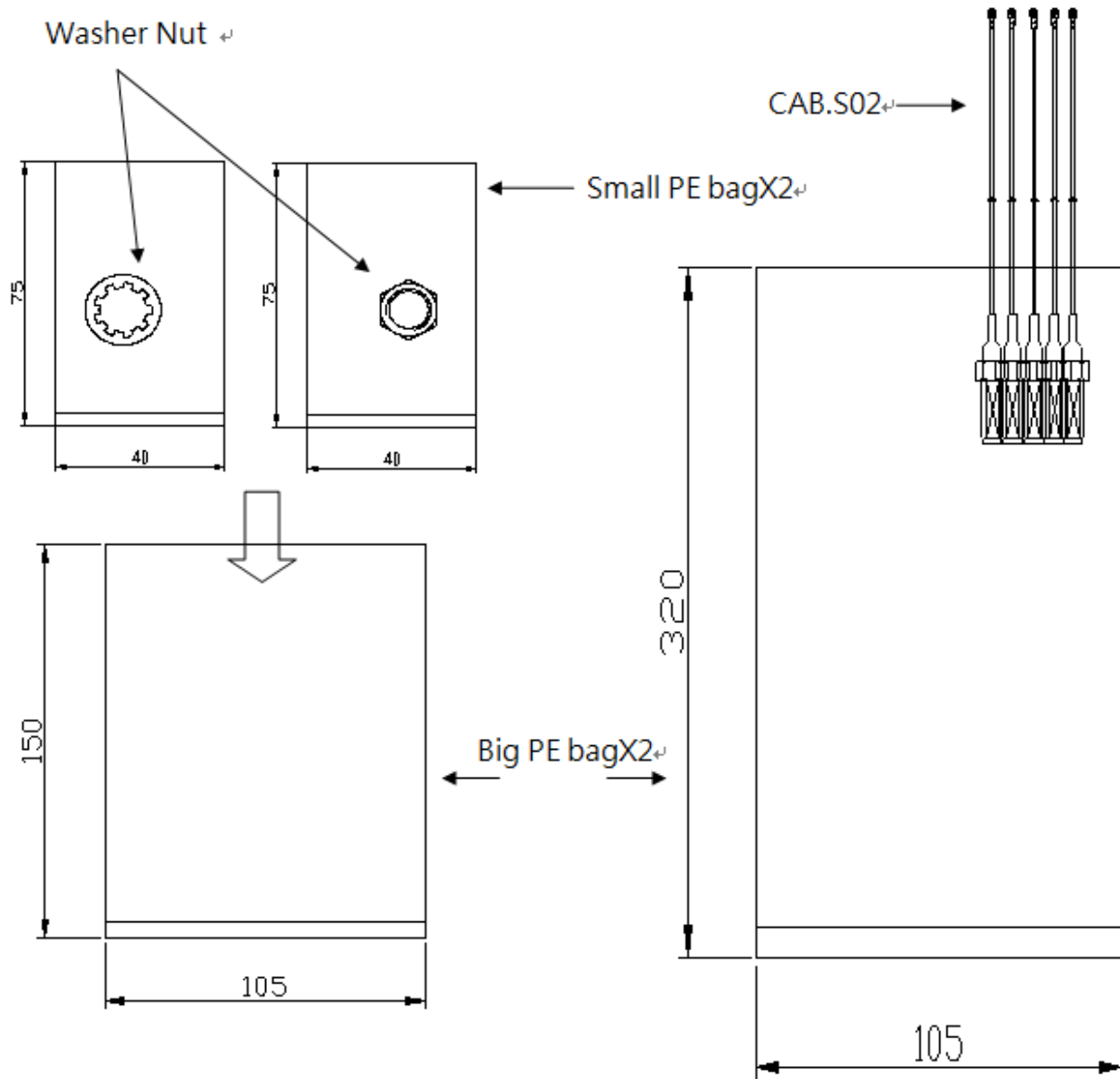

New Package

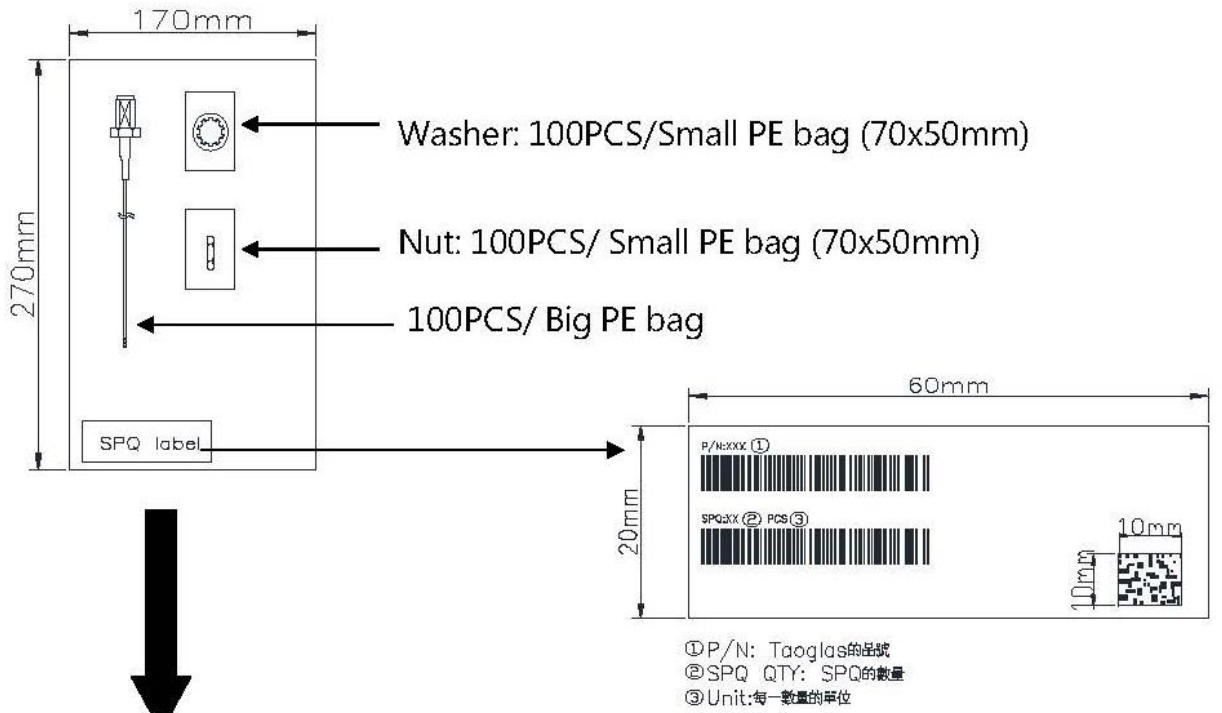

3000PCS/Carton

(327x280x218mm)

