



# TAOGLAS<sup>®</sup>



# Datasheet

**Part No:**  
AGPDFD6010A

**Description**

Eval Board for GPDF6010.A with TFM.120A & 2x HC125A $\emptyset$ 101x1.59mm Circular PCB

**Features:**

Optimum Active Electronics Design for Passive GNSS L1/L2/L5/L-Band Antenna  
Integrated TFM Module and Hybrid Coupler

Bands Covered:

- BeiDou (B1/B2a)
- GPS/QZSS (L1/L5)
- GLONASS (G1)
- Galileo (E1/E5a)
- L Band Corrections

Dual pin, dual feed, 4-pin configuration

Dimensions: 45 x 45 x 10mm

RoHS & Reach Compliant

<b>1.</b>	<b>Introduction</b>	<b>3</b>
<b>2.</b>	<b>Specification</b>	<b>5</b>
<b>3.</b>	<b>Mechanical Drawing</b>	<b>7</b>
<b>4.</b>	<b>Integration Guide</b>	<b>8</b>
<b>5.</b>	<b>Antenna Characteristics</b>	<b>12</b>
<b>6.</b>	<b>Radiation Patterns</b>	<b>14</b>
<hr/>		
	Changelog	22

Taoglas makes no warranties based on the accuracy or completeness of the contents of this document and reserves the right to make changes to specifications and product descriptions at any time without notice. Taoglas reserves all rights to this document and the information contained herein. Reproduction, use or disclosure to third parties without express permission is strictly prohibited.

Ireland & USA  
ISO 9001:2015  
Certified



Taiwan  
ISO 9001:2015  
Certified



# 1. Introduction

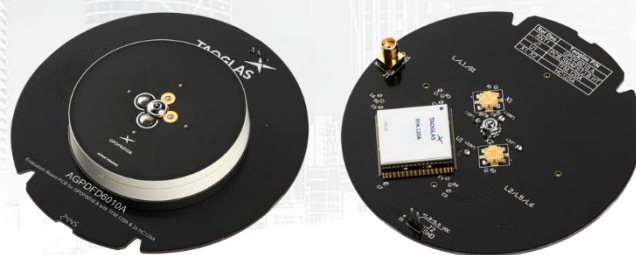

## Taoglas GNSS Reference Design Evaluation Boards

The Taoglas series of GNSS Antenna Reference Boards are designed to show the optimum component layout and make it easy for you to integrate the active electronics with the passive GNSS antenna on your device PCB.

Designing active GNSS electronics can be difficult, but utilising Taoglas' **TFM Series** of front end active electronics and hybrid couplers allow you to achieve the best possible positioning performance for your device. The Taoglas TFM module features a SAW/LNA/SAW/LNA topology in both the low and high band signal paths to prevent unwanted out-of-band interference from overdriving the GNSS LNAs or receiver.

### Features and Benefits of utilising the TFM Modules.

**Ease-of-integration** – Single-package solution combines impedance matching, filter efficiency and low noise design for easy, drop-in use with any antenna or GNSS receiver

**Low-noise System Design** – Integrated pre-filters deliver exceptional out-of-band rejection across multiple band configurations and neighbouring interference to properly set noise figure

**Dual-gain Stage Architecture** – Cascaded LNAs, pre-filters and optimized impedance matching deliver sufficient gain to the GNSS receiver without signal-to-noise overload

**Low-profile Form Factor** – Small footprint and low-profile design saves valuable real estate without the need for external components and routing

**Accelerated Development Cycles** – 2+ years of development by antenna and RF design experts, delivering the highest levels of integration, manufacturability and robustness in a single package

View the full series here:

<https://www.taoglas.com/product-category/other-rf-components/front-end-modules/>

Where used, the Taoglas **HC125A** is a low profile, high performance, 3dB hybrid coupler designed for multi-feed Multiband GNSS applications. The HC125.A is ideal for applications where balanced power and low noise amplifiers are required. For more information on the HC125A, visit the product page [here](#).

Please visit the standard product page for the GPDF6010A to download the integration files in Altium, 2D and 3D formats for your project by clicking [here](#).

For more information or to order samples, reach out to your regional Taoglas customer support team.

## 2. Specification

GNSS Frequency Bands					
GPS	L1 1575.42 MHz	L2 1227.6 MHz	L5 1176.45 MHz		
	■	■	■		
GLONASS	G1 1602 MHz	G2 1248 MHz	G3 1207 MHz		
	■	□	□		
Galileo	E1 1575.24 MHz	E5a 1176.45 MHz	E5b 1201.5 MHz	E6 1278.75 MHz	
	■	■	□	■	
BeiDou	B1C 1575.42 MHz	B1I 1561 MHz	B2a 1176.45 MHz	B2b 1207.14 MHz	B3 1268.52 MHz
	■	■	■	□	□
L-Band	L-Band 1542 MHz				
	■				
QZSS (Regional)	L1 1575.42 MHz	L2C 1227.6 MHz	L5 1176.45 MHz	L6 1278.75e6	
	■	■	■	■	
IRNSS (Regional)	L5 1176.45 MHz				
	■				
SBAS	L1/E1/B1 1575.42 MHz	L5/B2a/E5a 1176.45 MHz	G1 1602 MHz	G2 1248 MHz	G3 1207 MHz
	■	■	■	□	□

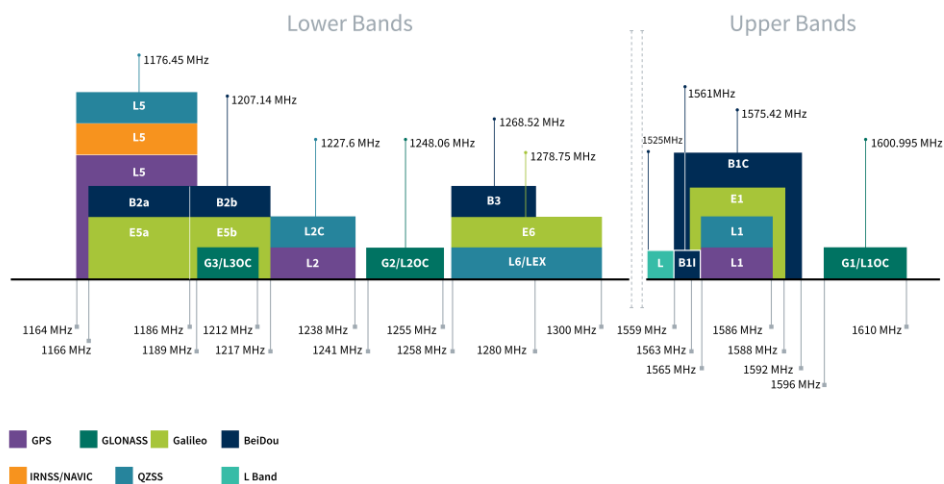

GNSS Bands and Constellations

GNSS Electrical							
Frequency (MHz)	1176.45	1227.6	1278.75	1542	1561	1575.42	1603
Peak Gain (dBi)	24.94	30.33	25.68	28.54	28.92	28.67	27.04
Axial Ratio (dB)	1.6	2.65	2.94	1.15	0.97	0.95	1.1
PCO_x (cm)	-0.68	-0.29	-0.05	-0.15	-0.21	-0.26	-0.37
PCO_y (cm)	-2.09	-2.26	-2.51	-2.67	-2.6	-2.56	-2.47
PCV (cm)	1.73	1.24	1.09	0.69	0.74	0.74	0.81
Group Delay Mean (ns)	8.8	10.19	7.44	10.48	9.87	9.62	9.66
Polarization	RHCP						
Impedance	50 Ω						

Mechanical	
Dimensions	∅100.4 x 23.8mm
Material	PET
Connector	SMA(F)

Environmental	
Operation Temperature	-40°C to 85°C
Storage Temperature	40°C to 85°C
RoHs & REACH Compliant	Yes

### 3. Mechanical Drawing

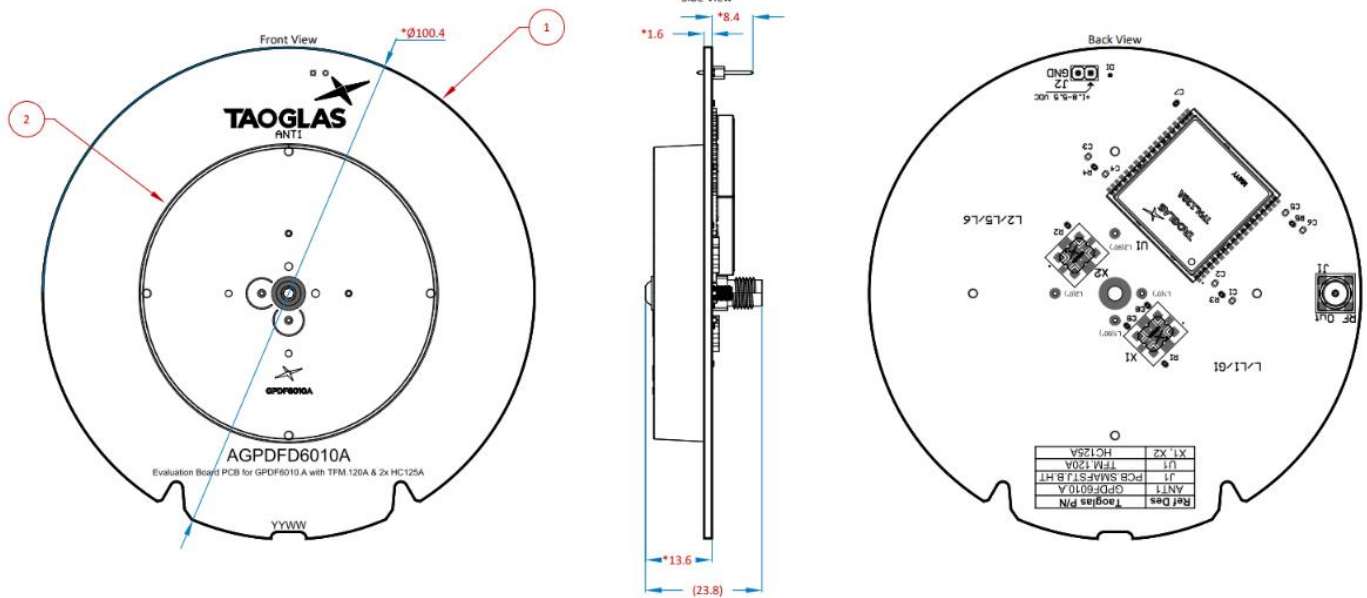

Bill Of Materials

Line #	Description	Quantity	MFG	MFGPN
1	SMD_AGPDFD6010A_Dual Layer D100.4 H1.6mm NP-140 35um Glossy Black	1	Taoglas	AGPDFD6010A
2	GPDF6010.A/PPK	1	Taoglas	GPDF6010.A

## 4. Integration Guide

The following is an example on how to integrate the [TFM.120A](#) into a design. In this example, the [GPDF6010.A](#) is used as the antenna. This antenna has four pins, two pins are used for L1 band, and two pins are used for L2/L5/L6 bands. Hybrid couplers ([HC125A](#)) are used to combine the feeds for each of the bands, to create a Right hand circular polarized (RHCP) signal, before being presented to the corresponding inputs on the [TFM.120A](#). The [TFM.120A](#) is powered from a separate power DC supply (1.8V-5.5V). The output of the [TFM.120A](#) can then be fed to a relevant GNSS receiver module. Taoglas recommends using a minimum of 100mm diameter or 100x100mm ground plane (PCB) to ensure optimal performance.

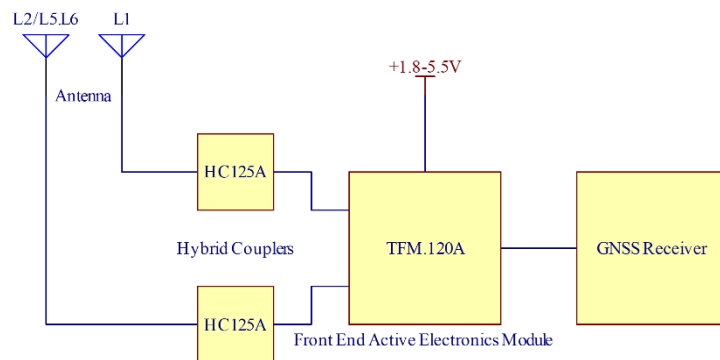

Block Diagram of integration of the TFM.120A

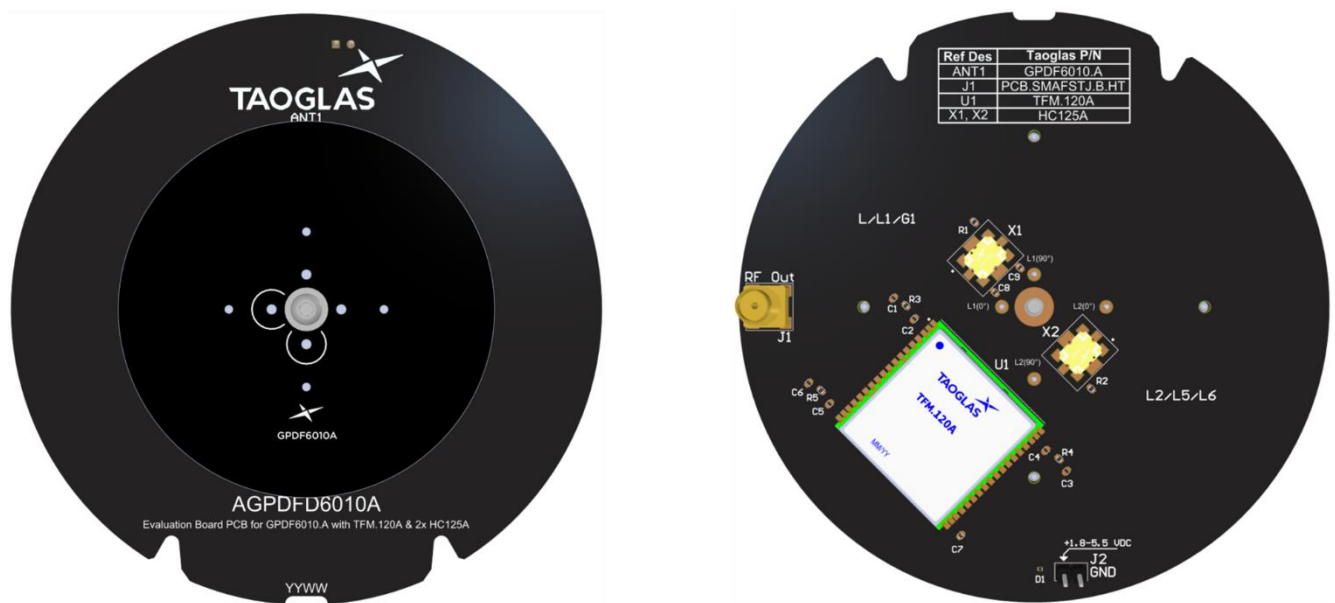

Top and bottom view of PCB.



## 4.1 Schematic Layout

The [GPDF6010.A](#) uses two orthogonal feeds that need to be combined in a hybrid coupler to ensure optimal axial ratio. Taoglas recommends our [HC125A](#), a high-performance hybrid coupler specifically engineered for use with our multi feed patches.

Two [HC125A's](#) are required for this antenna, one for the high GNSS band of operation (1559- 1610MHz), L band and another for the low GNSS band (1180MHz – 1280MHz). These hybrid couplers should be placed close to the antenna pins and terminated correctly using a 49.9 Ohm resistors.

The output of each of the hybrid couplers can be fed into the relevant inputs of the [TFM.120A](#) module.

Matching components with the [TFM.120A](#) are required for the module to have optimal performance in the spaces specified in the schematic below. Additional matching components may be necessary for your device, Taoglas recommends incorporating extra component footprints, forming a “pi” network, between the [TFM.120A](#) and the [HC125A's](#). Matching components should also be placed between the RF output pin and the GNSS receiver module input pin.

Taoglas recommends placing an ESD diode and decoupling capacitor (100pF) on the input pin of the supply rail.

Note: The RF In & RF out of the TFM module are all DC-blocked internally. External DC block capacitors are not required.

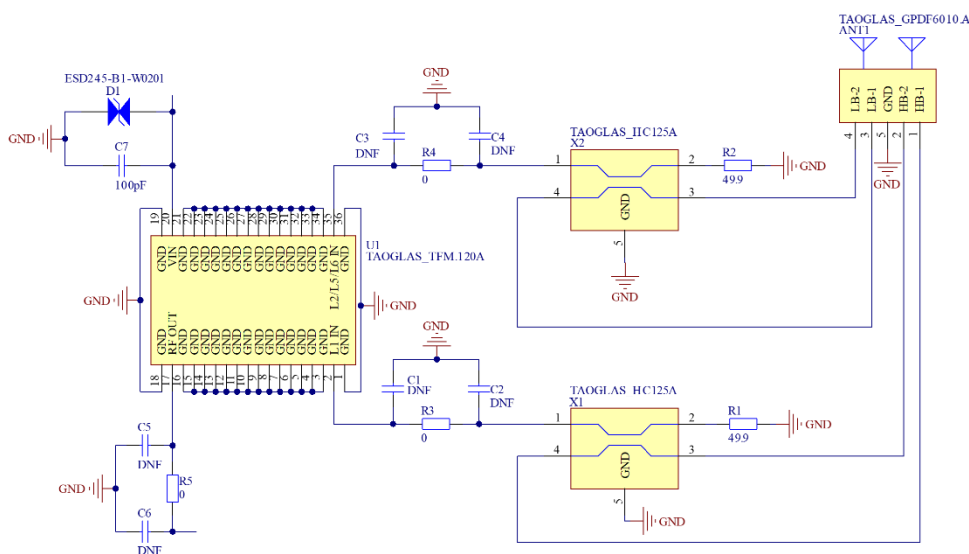

Schematic above shows how the TFM.120A and [GPDF6010.A](#) are integrated.

Designator	Type	Value	Manufacturer	Manufacturer Part Number
C1, C2, C4, C5, C6, C7	Capacitor	Not Fitted	-	-
C3	Capacitor	100pF	Murata	GRM1555C1H101JA01D
D1	Diode	-	Infineon	ESD245B1W0201E6327XTSA1
R2, R4	Resistor	49.9 Ohms	Panasonic	ERJ-2RKF49R9X
R1, R3, R5	Resistor	0 Ohms	YAGEO	RC0402JR-070RL

## 4.2 Module Integration

The [TFM.120A](#) should be placed as close to the signal input and output as possible to shorten the length of the transmission lines. The RF IN/OUT traces must maintain a 50 Ohm transmission line. A Pi Matching Network is recommended for the RF IN transmission lines, the values and components for the matching circuit will depend on the tuning needed. Ground vias should be placed beside each ground pad and the DC Voltage input should be between +1.8 and +5.5 VDC. It's recommended that the DC Voltage input should be coupled with a 100pF Capacitor and an ESD Diode.

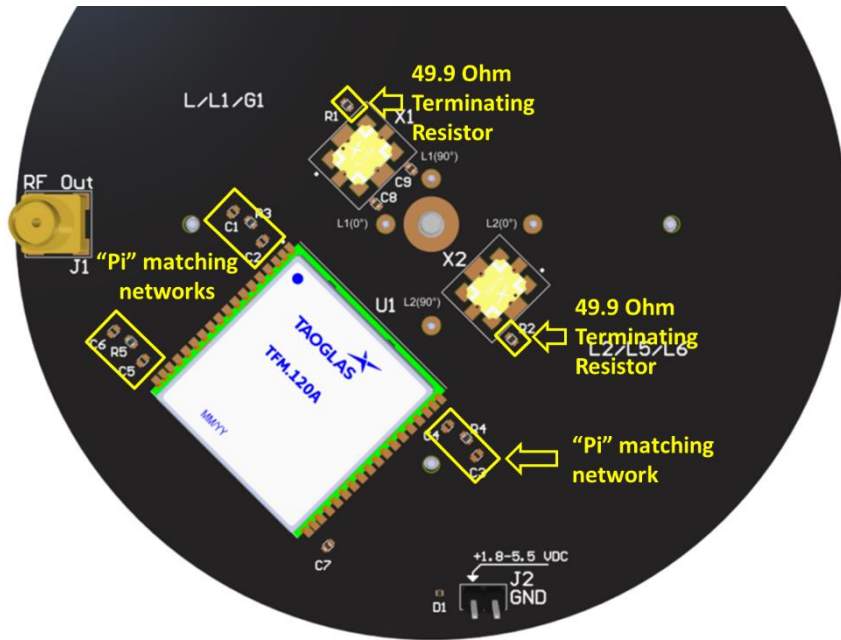

Bottom view of the PCB, showing “Pi” matching network.

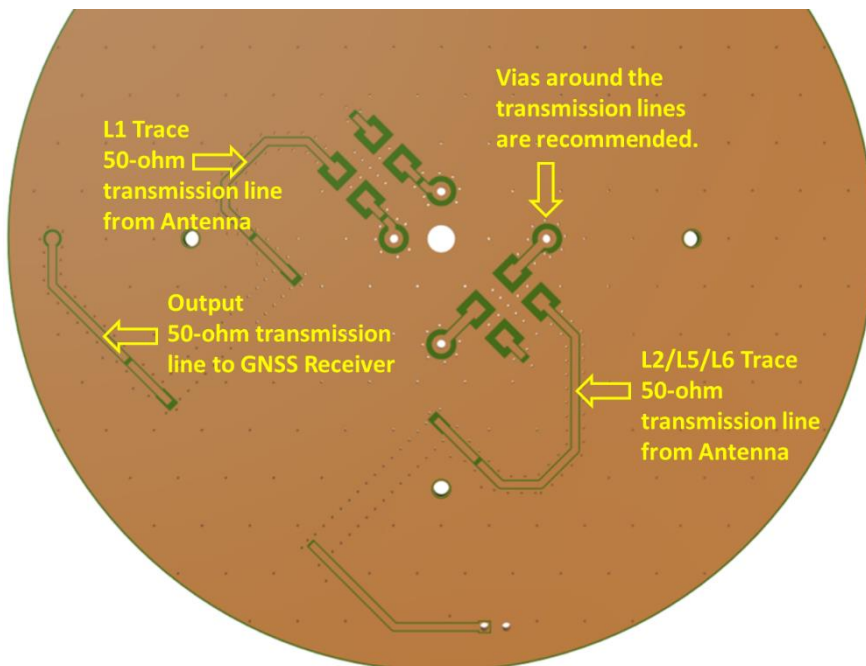

Bottom view of the PCB, showing transmission lines and integration notes.

### 4.3 Final Integration

The top side image shown below highlights the antenna connection to the hybrid couplers ([HC125A's](#)). It highlights the outputs of the hybrid couplers connected to the relevant inputs of the [TFM.120A](#) module. It shows the 49.9 Ohm terminating resistor necessary for the hybrid coupler ([HC125A](#)). It also demonstrates the output of the [TFM.120A](#) module that needs to be connected to a GNSS receiver input. It displays the DC connection required with ESD diode and decoupling capacitor.



Top Side ([GPDF6010.A](#) placement on 70x70mm PCB)

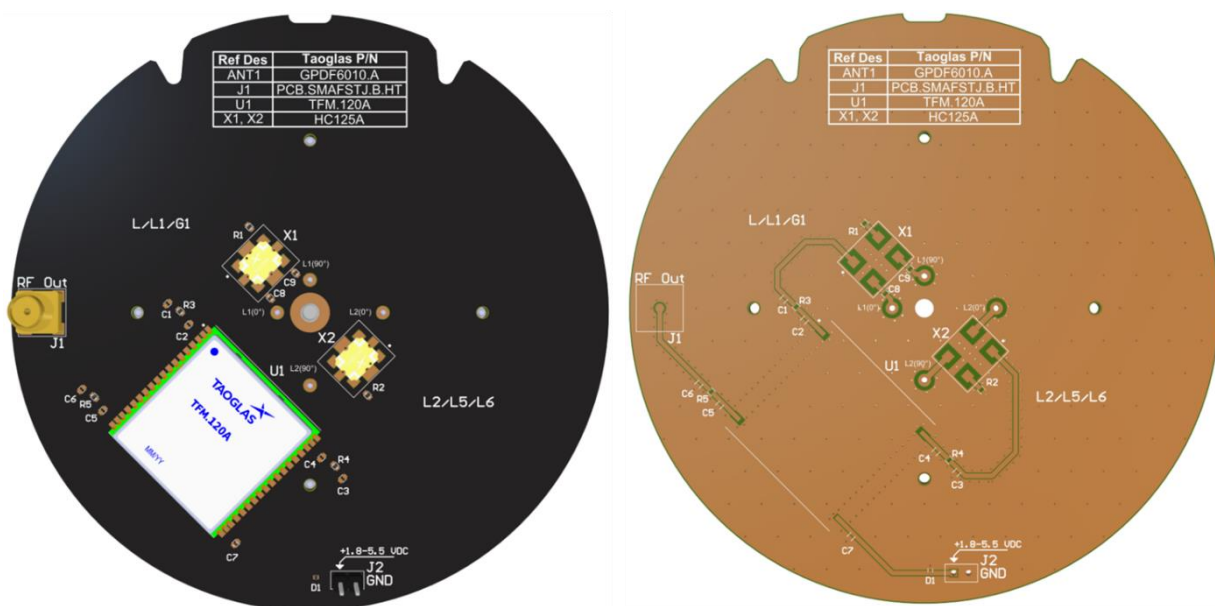

Bottom side ([TFM.120A](#) placement including [HC125A's](#))

## 5. Antenna Characteristics

### 5.1 Peak Gain

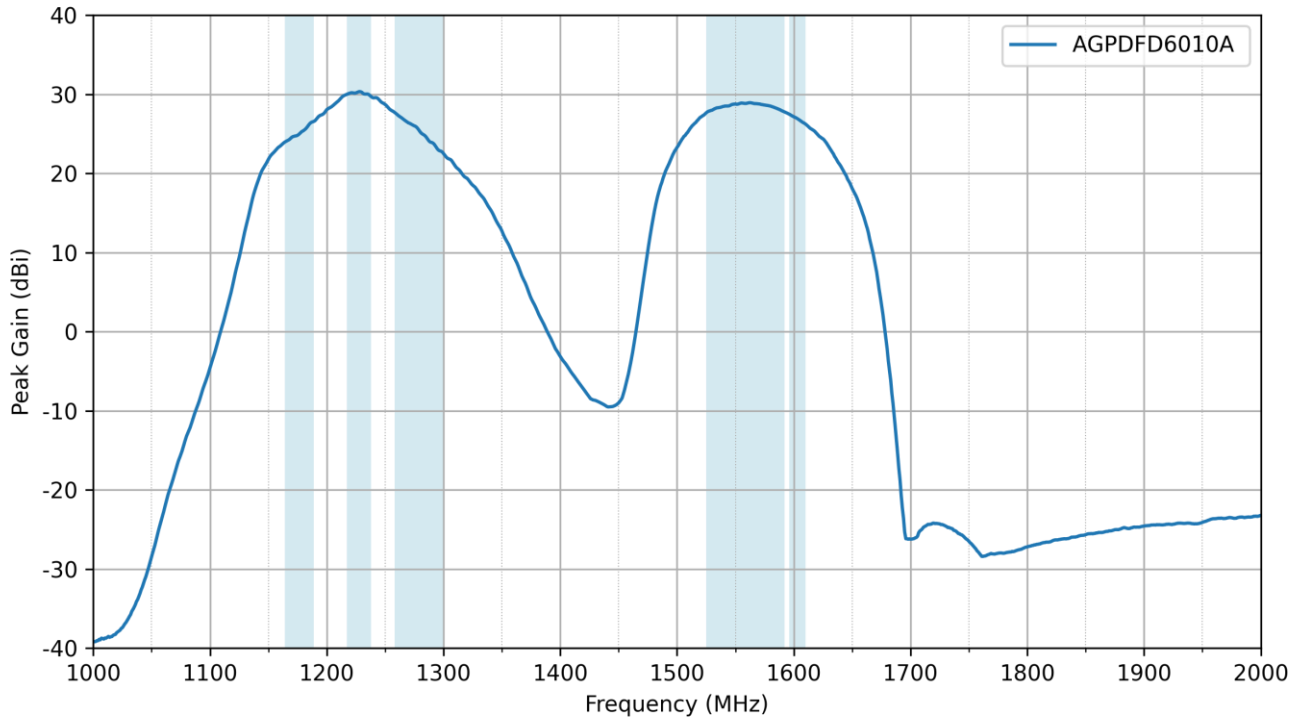

### 5.2 Axial Ratio

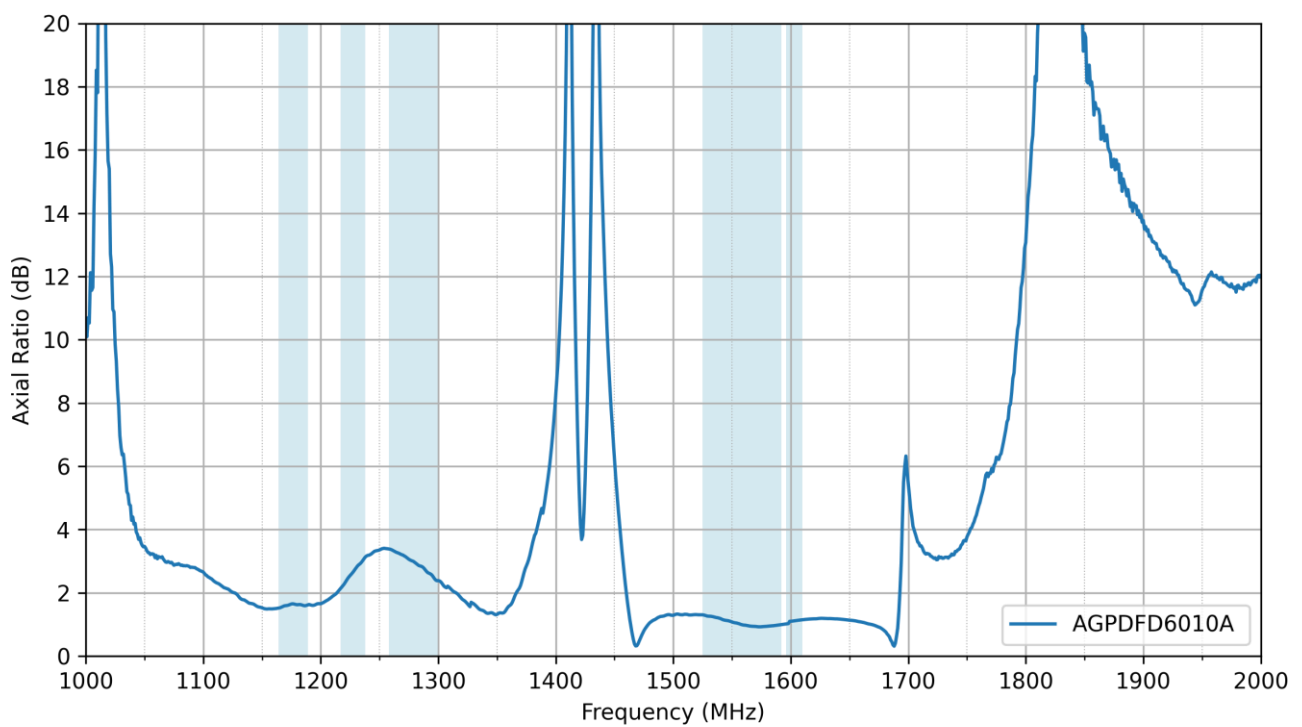

### 5.3 PCO

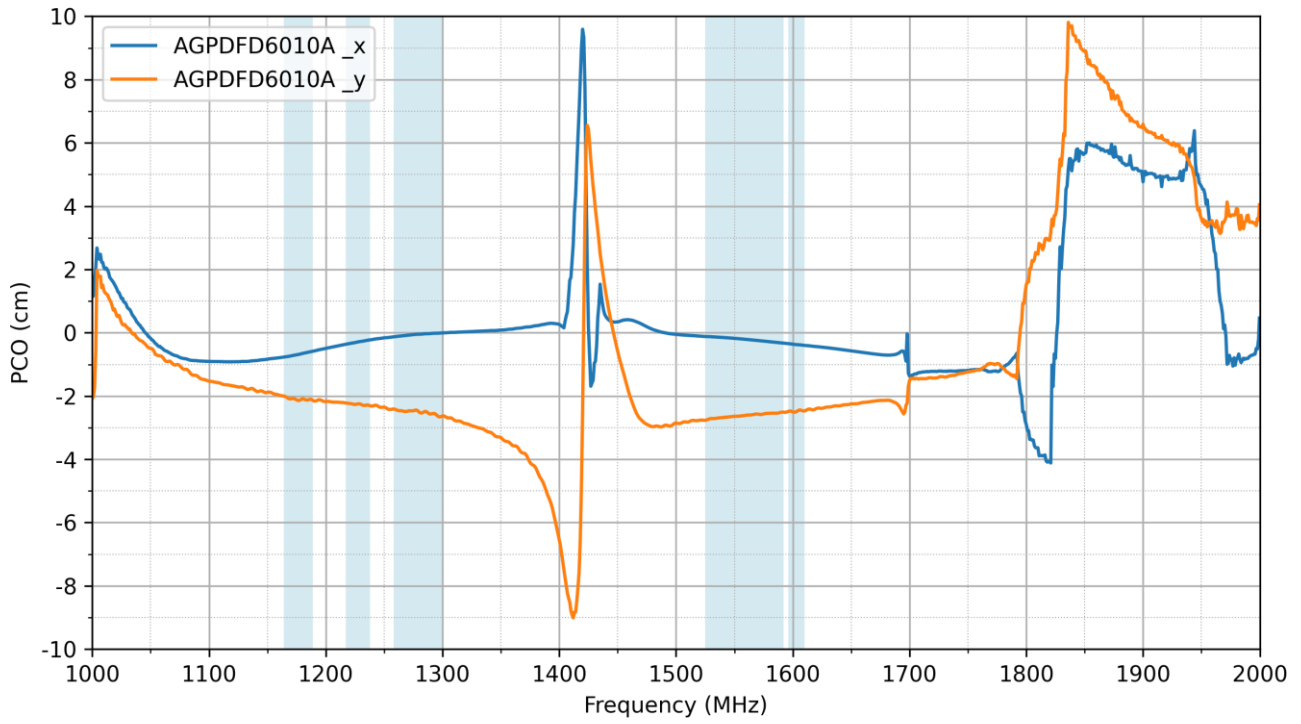

### 5.4 PCV

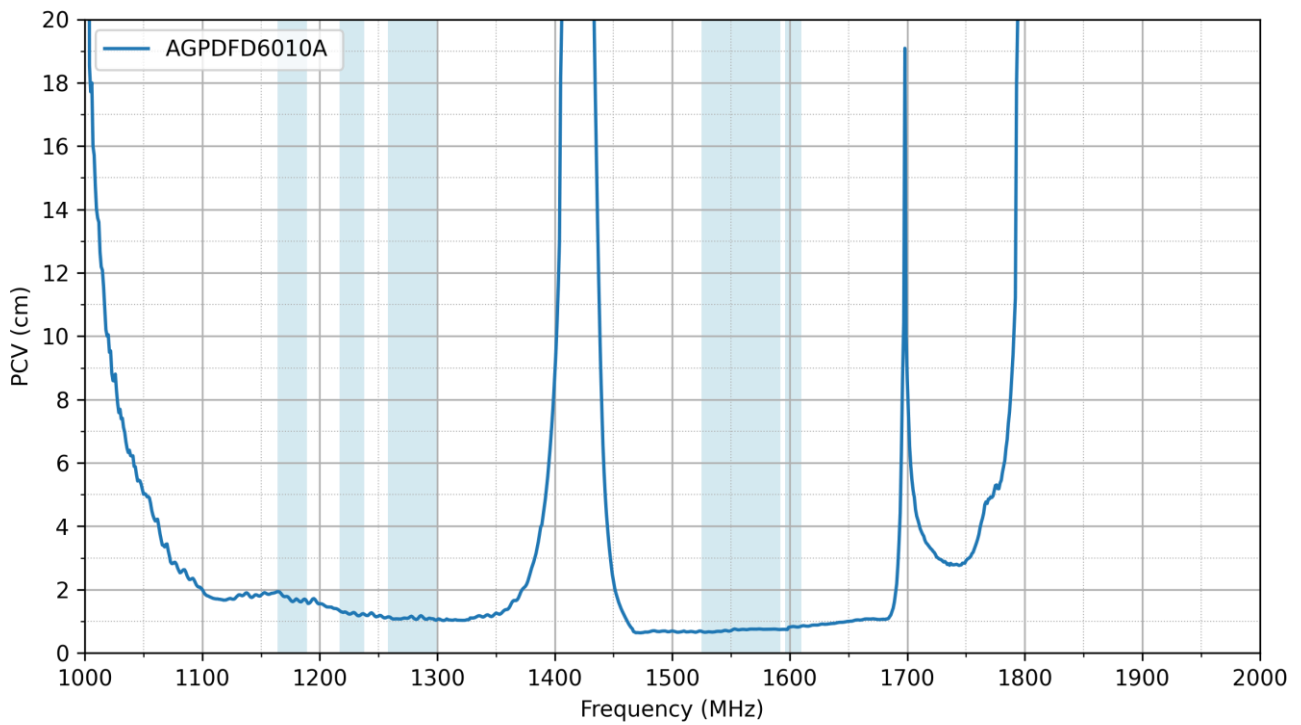

## 6. Radiation Patterns

### 6.1 Test Setup

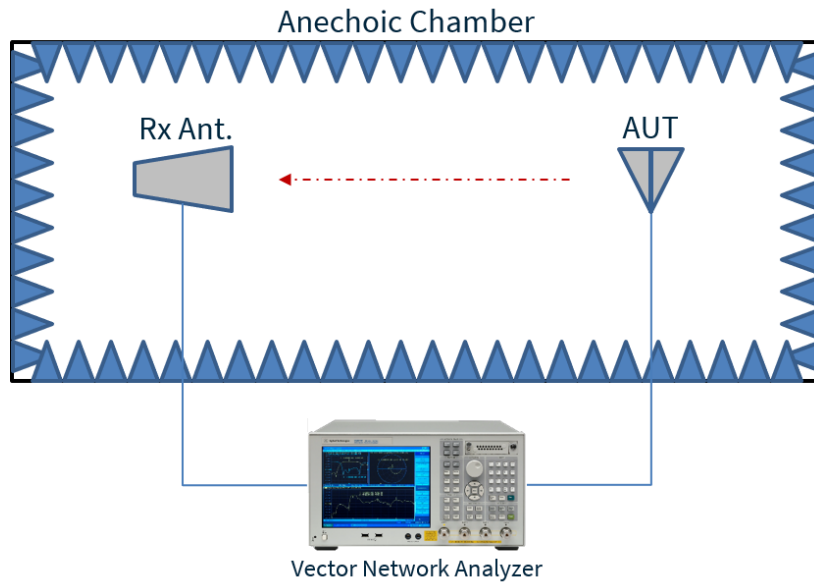

Chamber Test Set-up

6.2 Patterns at 1176 MHz

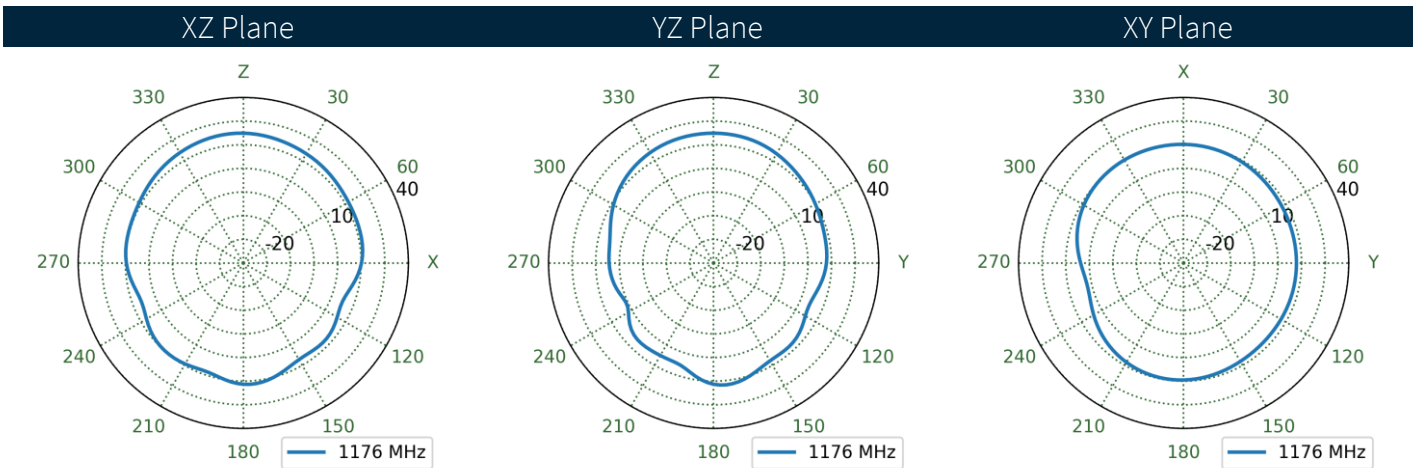
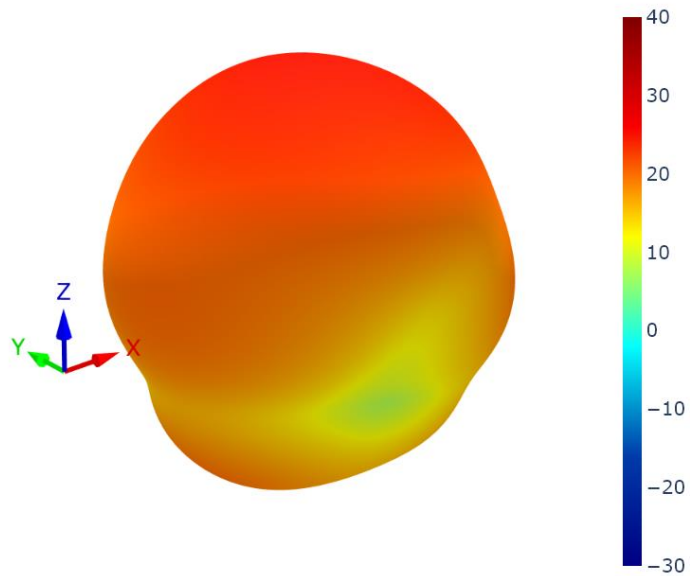

6.3 Patterns at 1227 MHz

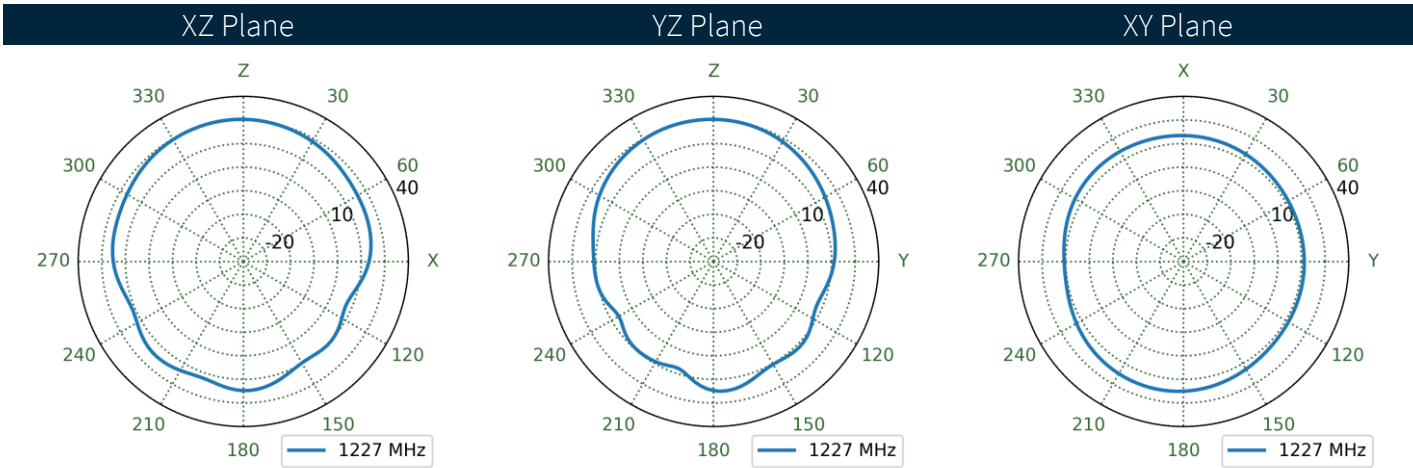
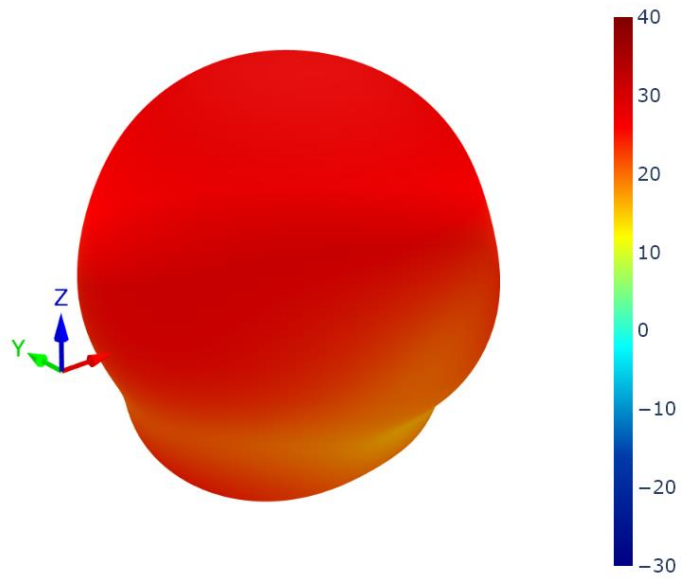



6.4 Patterns at 1279 MHz

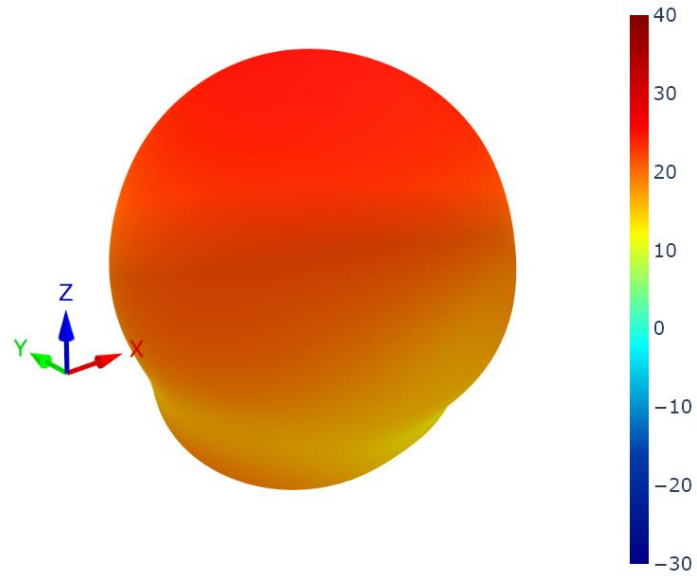

XZ Plane                      YZ Plane                      XY Plane

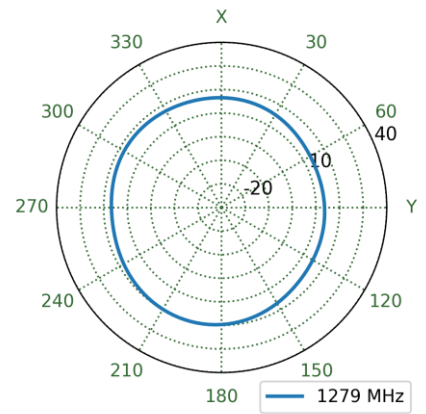
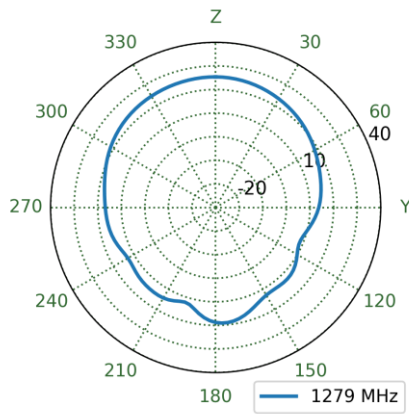
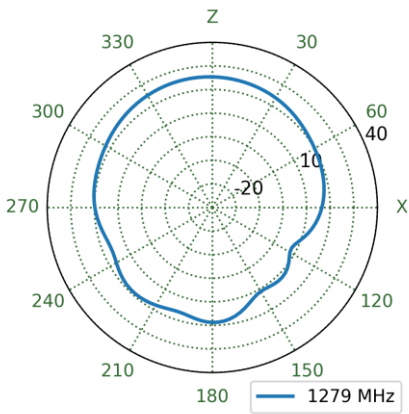

6.5 Patterns at 1542 MHz

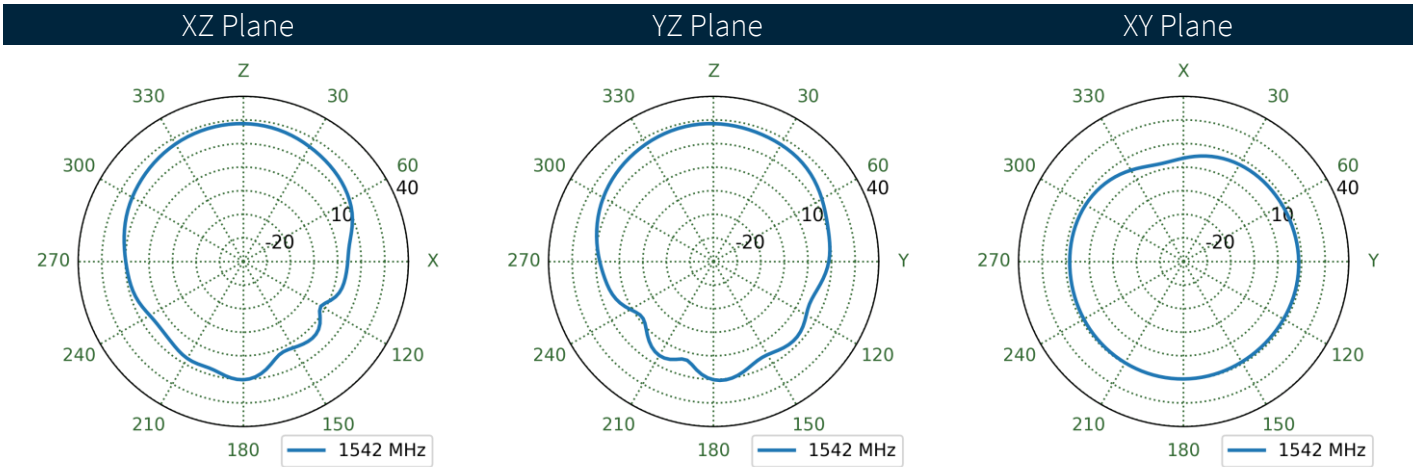
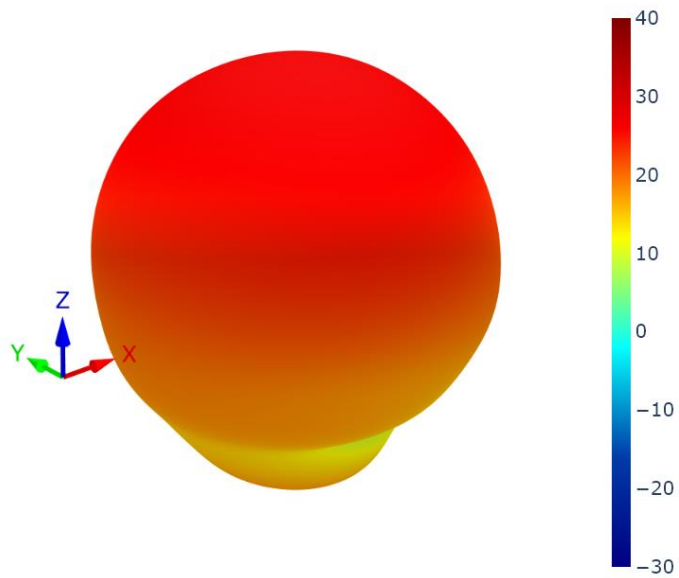

6.6 Patterns at 1561 MHz

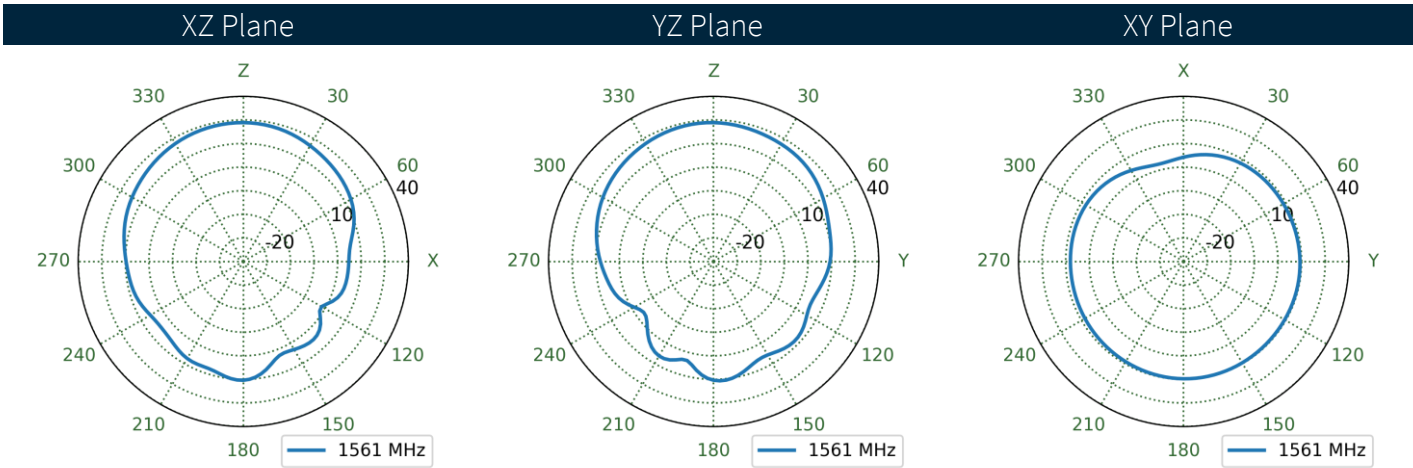
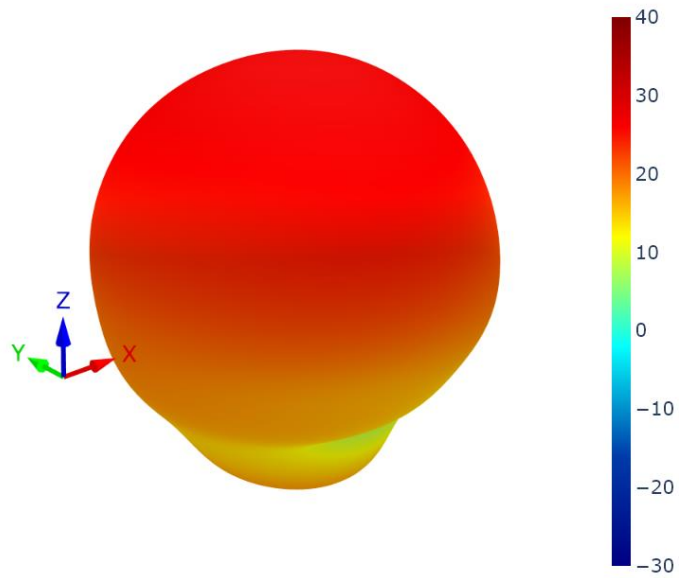

6.7 Patterns at 1575 MHz

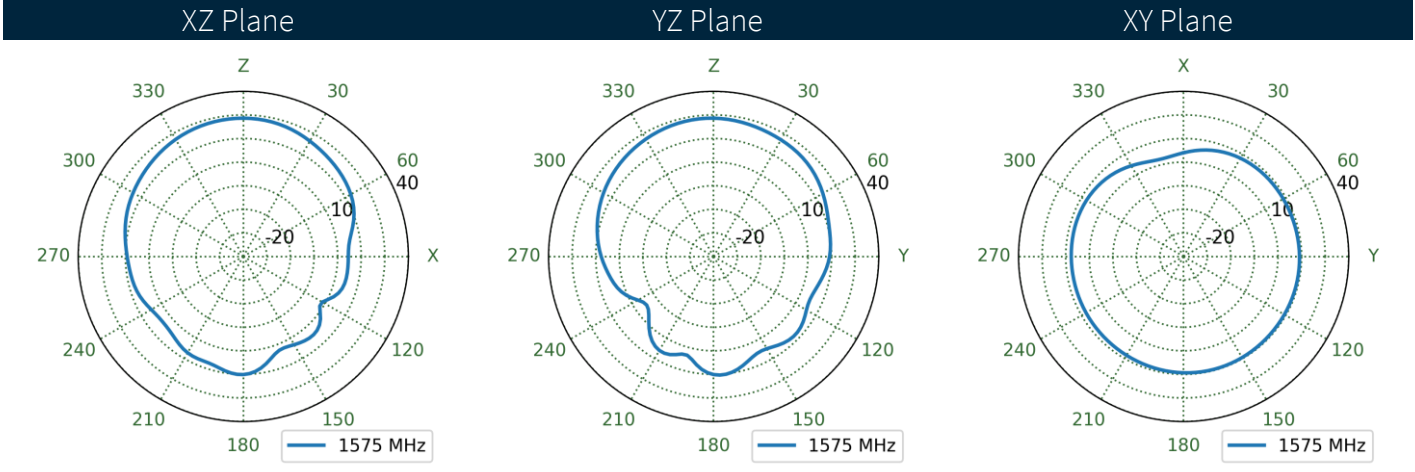
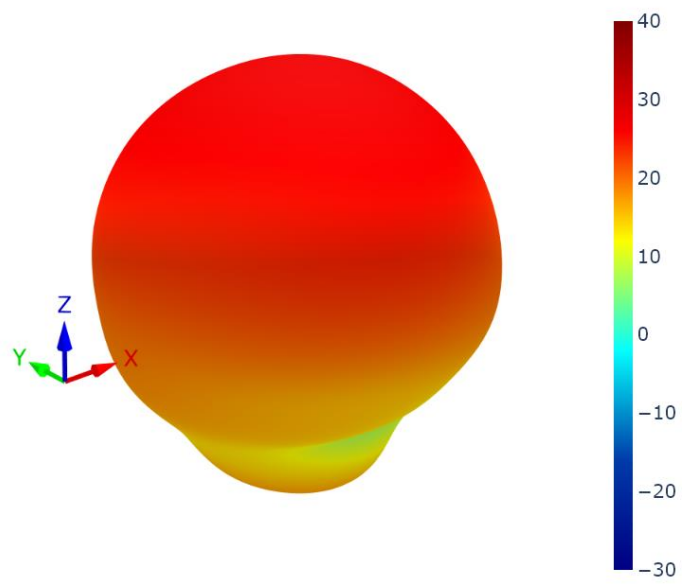

6.8 Patterns at 1602 MHz

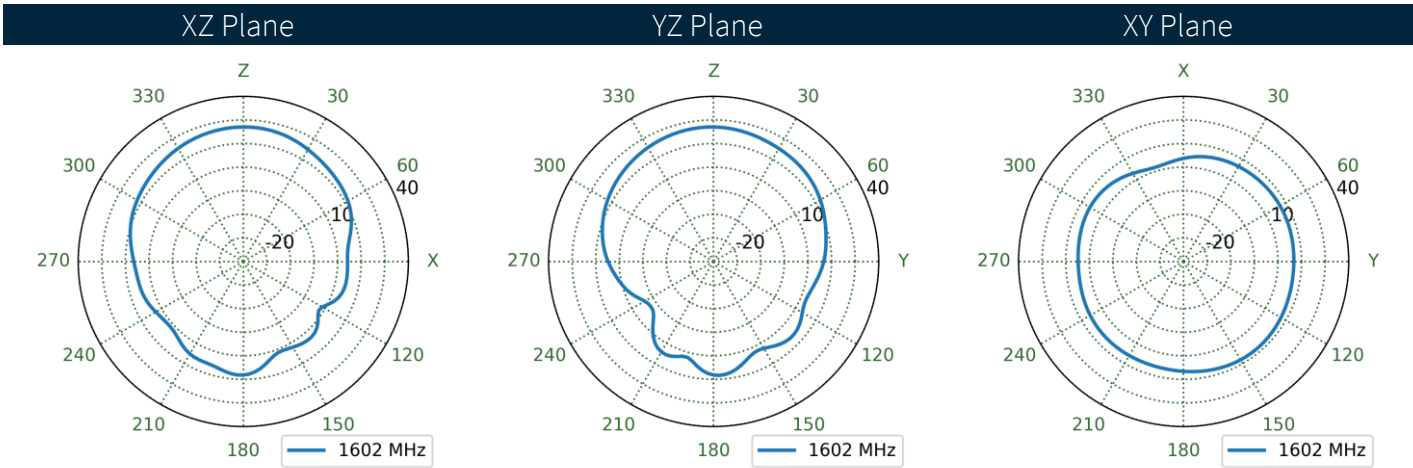
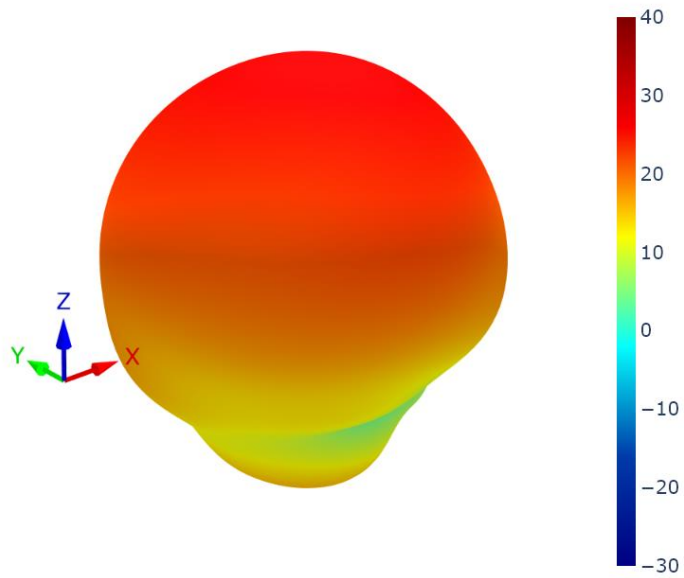

Changelog for the datasheet

**SPE-25-8-015 – AGPDFD6010A**

**Revision: A (Original First Release)**

Date:	2025-01-15
Notes:	Initial Release
Author:	Gary West

**Previous Revisions**