



Datasheet

Part No:
FXR.2525.B Series

Description:

NFC Flex Antenna (25*25*0.355mm) with a Reverse Ferrite Layer and adhesive backing

Features:

13.56 MHz Antenna
Reverse Ferrite Layer
Flexible Low Profile Embedded

Dimensions:

- Length and Height: 25 x 25mm
- FXR.2525.B.dg - NFC with ferrite
- FXR.2525.52.0075X.B.dg - NFC with ferrite and 75mm Twisted Pair 28AWG cable with ACH(F) connector

Peel and stick 3M adhesive

RoHS & Reach Compliant

| | |
|------------------------|----|
| 1. Introduction | 3 |
| 2. Specifications | 4 |
| 3. Antenna Application | 5 |
| 4. Mechanical Drawing | 10 |
| 5. Packaging | 12 |
| <hr/> | |
| Changelog | 13 |

Taoglas makes no warranties based on the accuracy or completeness of the contents of this document and reserves the right to make changes to specifications and product descriptions at any time without notice. Taoglas reserves all rights to this document and the information contained herein. Reproduction, use or disclosure to third parties without express permission is strictly prohibited.



1. Introduction



Taoglas FXR and FXC series of high-performance NFC (Near Field Communications) antennas are ideal for IoT and mobile devices and applications such as contactless payment systems, access control or RFID systems. The compact, flexible NFC antennas are supplied with adhesive backing for quick and easy installation and can be mounted inside a plastic device enclosure or on an internal battery. For any NFC antennas attached to a battery, we offer variants with ferrite flux directors to provide isolation from the battery or other electronic components within the device. Using the antenna on a conductive surface without a ferrite layer could result in a lossy antenna and communication performance issues.

Taking into consideration the many environments that the antenna could be used in, Taoglas offers five versions of each of the FXR and FXC series models. A standard model without ferrite and adhesive backing, two models with adhesive backing and a ferrite layer, one layer facing up, one down and a third model, again with ferrite facing up or down and with an a 75mm Twisted Pair 28AWG cable with ACH(F) connector compatible with ACH(M).

Typical Applications Include:

- Mobile Devices
- Wearable Smart Devices
- Payment Terminals
- Device tracking and ID systems
- Access control

To further optimization your specific device environments and for support on how to integrate and test this antenna's performance in your device, contact your regional Taoglas Customer Services Team.

2. Specifications

| Electrical | | |
|--------------------------|----------------------------|----------------------------|
| Part Number | FXR.2525.B.dg | FXR.2525.52.0075X.B.dg |
| Frequency | 13.56 MHz | 13.56 MHz |
| La | 1.05 μ H | 1.13 μ H |
| Rs | 2.09 ohm | 2 ohm |
| Q Factor | 42.47 | 47.41 |
| Self-Resonance Frequency | 476 MHz | 458 MHz |
| Rp | 83.19 kohm | 52.02 kohm |
| Mechanical | | |
| Antenna Dimensions | 25 x 25mm | 25 x 25mm |
| RoHS Compliant | Yes | Yes |
| Adhesive | 3M467 or 3M9460 | 3M467 or 3M9460 |
| Connector | n/a | ACH(F) |
| Cable | n/a | Twisted Pair 28AWG - PVC |
| Weight | 7.4g | 9.2 g |
| Environmental | | |
| Operation Temperature | -40°C to 85°C | -40°C to 85°C |
| Storage Temperature | -40°C to 85°C | -40°C to 85°C |
| Humidity | Non-condensing 65°C 95% RH | Non-condensing 65°C 95% RH |

* Contact pads are gold plated copper. Base material is polyimide which can take heat from soldering for brief periods suitable for attaching wires. Additional wire length will affect read range and result in different performance than that detailed in this document.

3. Antenna Application

3.1 Test Setup

A test fixture is used to measure the maximum interrogation distance. The FXR.2525.B antenna is connected to NFC evaluation boards and then placed under the PC material blocks to communicate with the standard card above them.

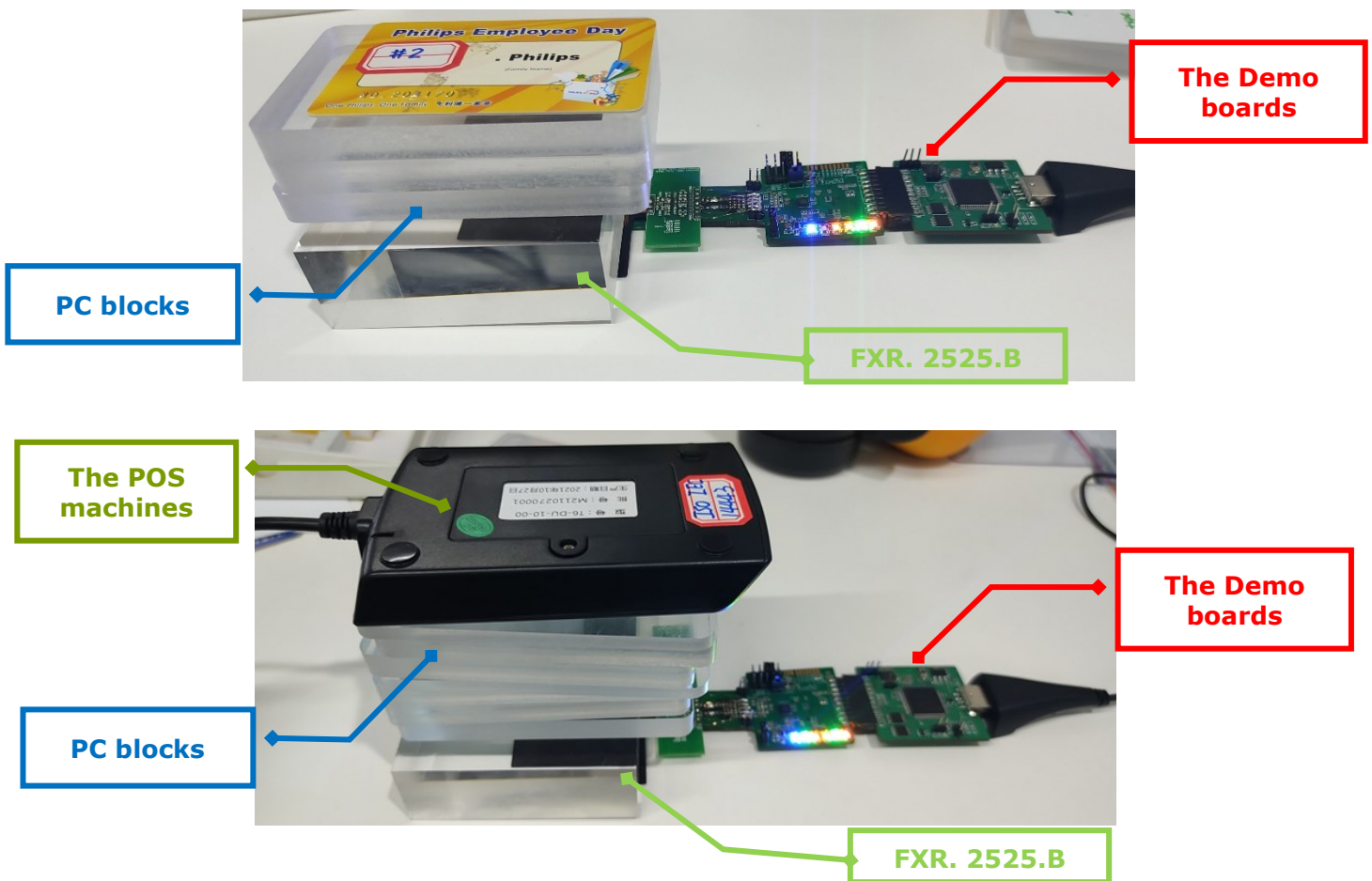

When the number of the PC material blocks are carefully adjusted until the reader can no longer read the sample, that's mean in this point the FXR.2525.B cannot establish communication with the standard card or the POS machine, the thickness of the PC material block is the maximum interrogation distance of them.

3.2 RFID Tags and POS Used for Test

A total of 5 NFC forum tags were used to measure the interrogation distances. The next picture shows type 1, type 2, type 3, type 4 and type 5 tags, respectively.



Type 1 is based on ISO/IEC 14443A standard and has 96 bytes of memory.

Type 2 is based on ISO/IEC 14443A standard and has 144 bytes of memory.

Type 3 is based on ISO-18092, JIS-X-6319-4 Sony Felica standard and has 9k bytes of memory.

Type 4 is based on ISO / IEC 14443A 1-4 compliant and has 4K of memory

Type 5 is based on ISO-15693 specification, the communication with this NFC Forum Tag type is based on NFC-V Technology.

3.3 The POS machine used for test

The next picture shows the POS machine using to measure the Card emulation performance of the FXR.2525.B Series NFC antennas.



ACR122 is a PC-linked contactless smart card reader/writer developed on the 13.56MHz Contactless (RFID) Technology and followed the ISO/IEC18092 Standard for Near Field Communication (NFC), supporting not only MIFACE® ISO 14443 A and B cards but also NFC and FELICA contactless technologies.

The ACR122 is a USB Plug and Play device with CCID compliance. By making use of up to 424 Kbps for NFC Tag access and full USB speed of up to 12 Mbps, the ACR122 can read and write faster and more efficiently. The proximity operating distance of ACR122 is up to 5 cm, depending on the type of contactless tag in use. Operating distance can be extended on request by adding an RF booster, so the ACR122 is suitable for logistics and supply chain management.

T6-BU-00-00 is a 13.56MHz high frequency readable and writable device, a USB drive-free RFID reader card which supports ISO14443 standard protocol Class A card reading and writing read and write. Also, T6-BU-00-00 is a module that can be set to read and write a chip card that supports the ISO15693 standard protocol.

3.3 Matching

The interrogation distances presented here were taken with the antenna connected directly to the evaluation boards with the optimized matching circuit. For the NXP PN7160 chipset, it is suggested using 20ohm impedance of the NFC antenna. Just like below:

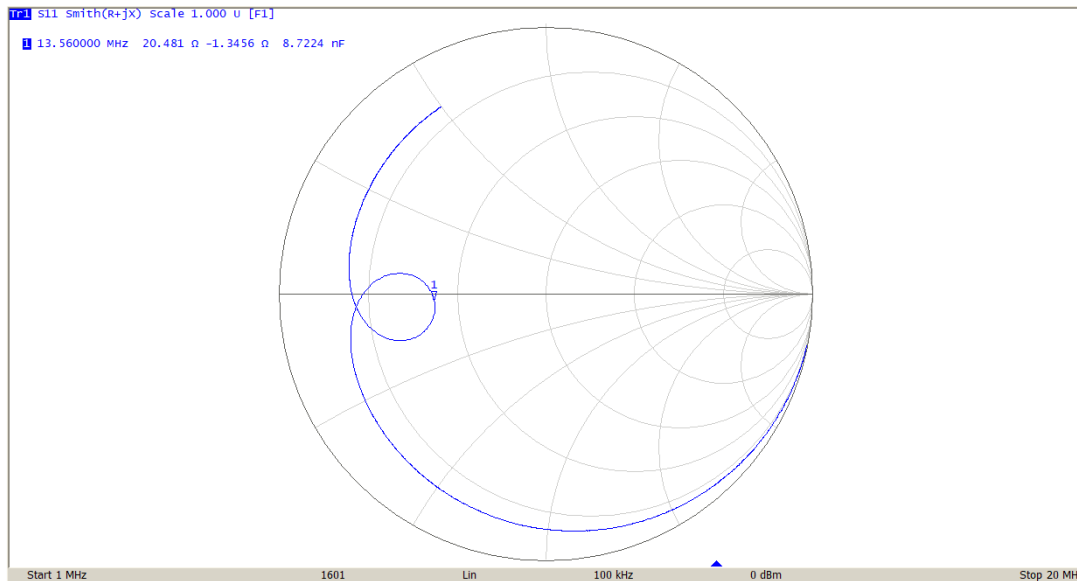

As with any matching network the exact circuit and values for an optimal network depend on the combination of antenna, NFC circuit, any intervening transmission line and the environment presented to the antenna. These factors are specific to the particular end product.

As a starting point, to achieve the read range results presented here, use the matching network detailed in the schematic of the evaluation board for your particular NFC chip and keep the antenna free of any obstruction. Once you can demonstrate successful reads you can then optimize performance as desired.

3.4 Read/Write & Card emulation mode

The NFC forum card type 1~5 were used to measure the interrogation distances in Read/write mode. The POS machine ACR122, T6-14443 T6-15693 were used to measure the interrogation distances in Card emulation mode. The results are in the next tables:

| Device | Interrogation Distance(mm) | |
|-------------------------|----------------------------|------------------------|
| | FXR.2525.B.dg | FXR.2525.52.0075X.B.dg |
| Topaz512 (Type 1) | 32 | 29 |
| NTAG203 (Type 2) | 32 | 30 |
| Sony Felica (Type 3) | 23 | 23 |
| Mifare DESFire (Type 4) | 14 | 12 |
| ISO 15693 (Type 5) | 61 | 58 |
| ACR122 | 54 | 48 |
| T6-14443 | 36 | 30 |
| T6-15693 | 52 | 44 |

4. Mechanical Drawing (Units: mm)

4.1 FXR.2525.B.dg

1. All material must be RoHS compliant.
 2. Use this drawing together with the corresponding 3D CAD database file to fully describe the part.
 3. The connector orientation has a fixed position to the antenna as per drawing.
- *** Critical Dimensions.

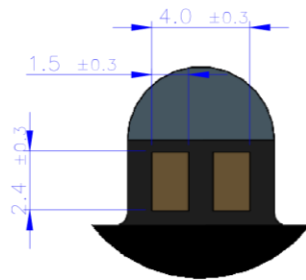

細部放大圖 A
縮放 4 : 1

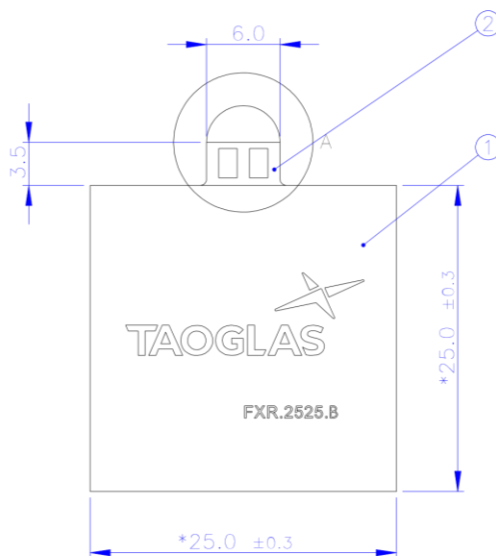

Release Liner

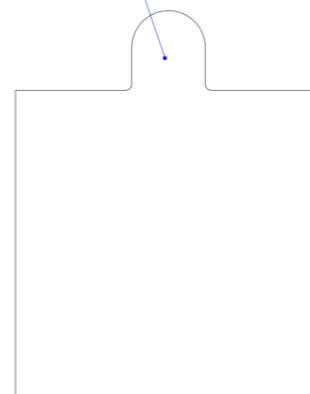

| | Name | Material | Finish | Qty |
|---|-----------------------|--------------------------------------|---------------|-----|
| 1 | Ferrite with adhesive | Cover Film/Ferrite/Adhesive | Natural | 1 |
| 2 | FPC with adhesive | ED copper/PI Base/ED Copper/Adhesive | Ni/Au Plating | 1 |

4.2 FXR.2525.52.0075X.B.dg

1. All material must be RoHS compliant.
 2. Use this drawing together with the corresponding 3D CAD database file to fully describe the part.
 3. The connector orientation has a fixed position to the antenna as per drawing.
- *** Critical Dimensions.

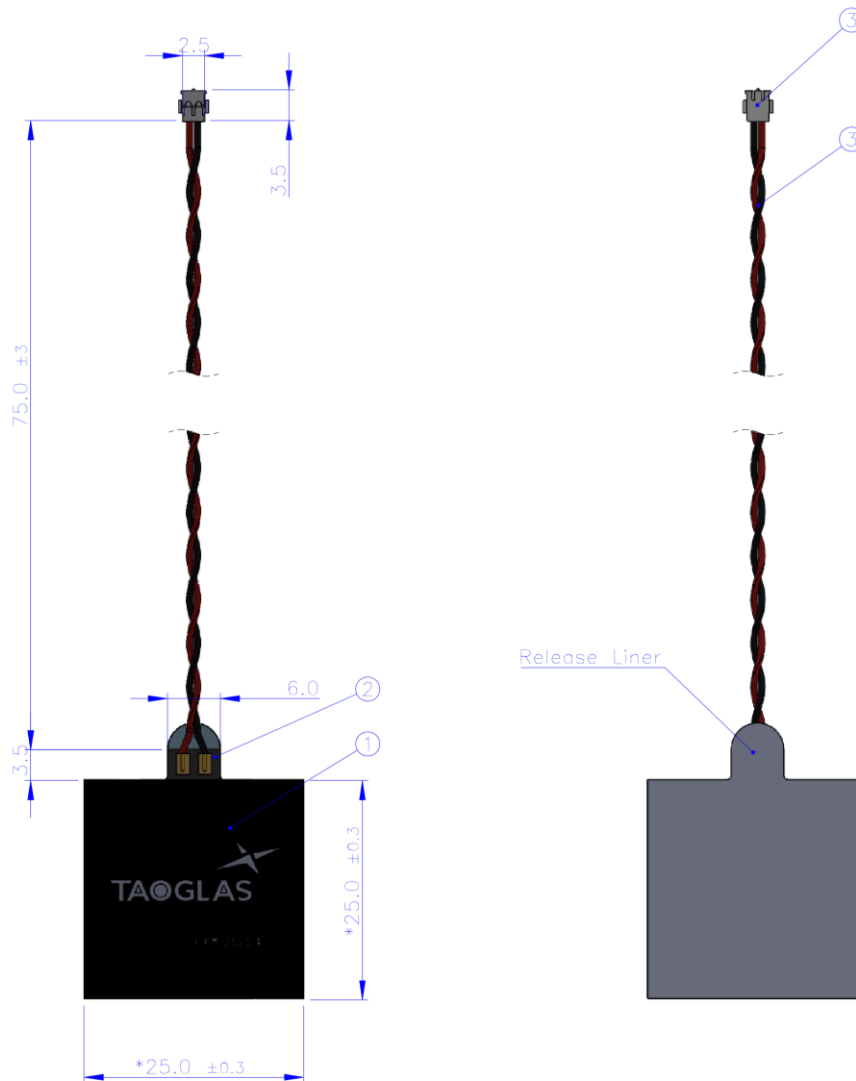

| | Name | Material | Finish | Qty |
|---|-------------------------------------|--------------------------------------|---------------|-----|
| 1 | Ferrite with adhesive | Cover Film/Ferrite/Adhesive | Natural | 1 |
| 2 | FPC with adhesive | ED copper/PI Base/ED Copper/Adhesive | Ni/Au Plating | 1 |
| 3 | Twisted Pair 28AWG cable and ACH(F) | PVDF | Black & Red | 1 |

5. Packaging

10 pcs / Small PE Bag
 PE bag: 100 x 200mm
 SPQ Label
 Weight:
 FXR.2525.B.dg – 7.4g
 FXR.2525.52.0075X.B.dg – 9.2g



1000 PCS / Carton
 Carton: 230 x 175 x 160mm
 Carton Label
 Weight:
 FXR.2525.B.dg – 1011g
 FXR.2525.52.0075X.B.dg - 1191g

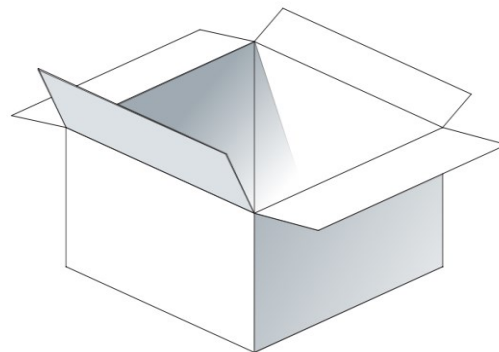

Changelog for the datasheet

SPE-24-8-107 – FXR.2525.B Series

| | |
|---|-------------|
| Revision: A (Original First Release) | |
| Date: | 2024-06-17 |
| Notes: | |
| Author: | Cesar Sousa |

Previous Revisions

| | |
|--|--|
| | |
| | |
| | |
| | |
| | |



TAOGLAS®

www.taoglas.com

