

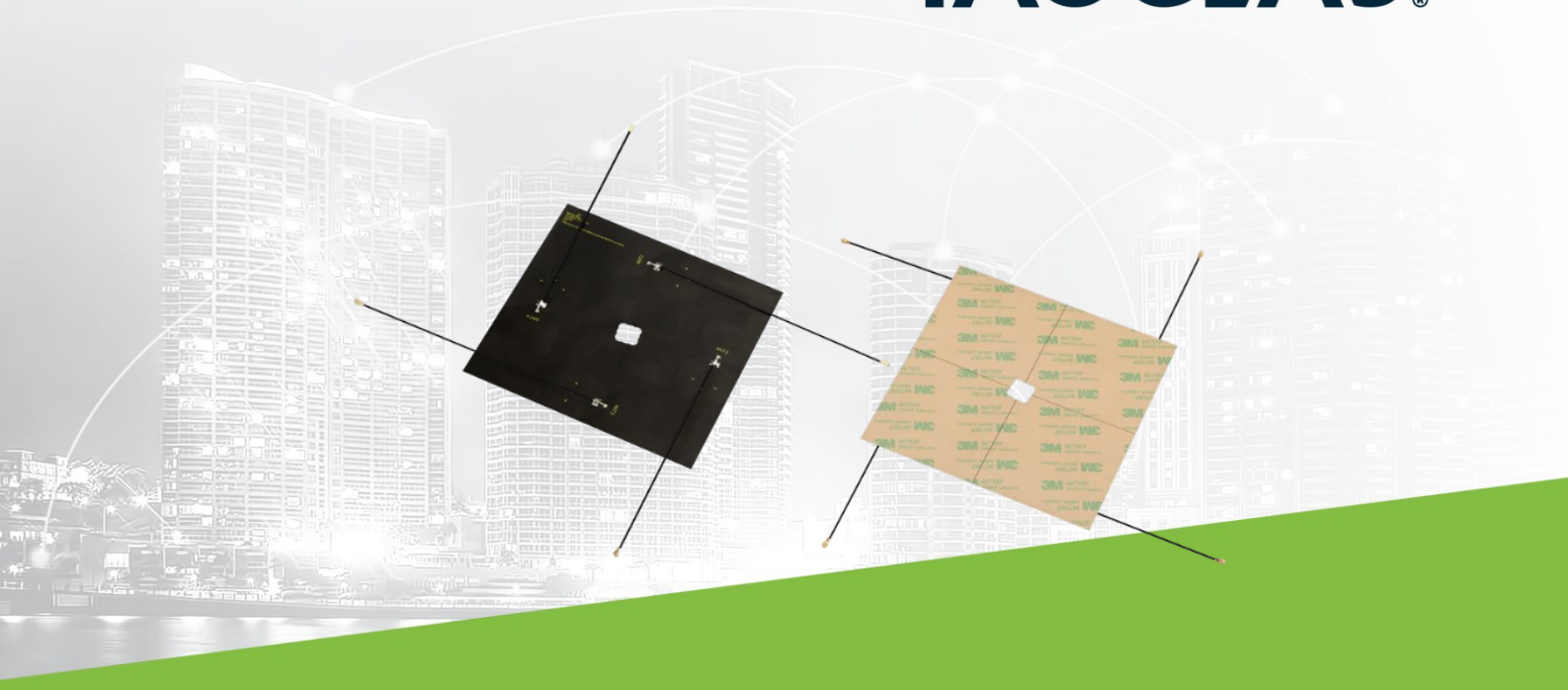

TAOGLAS®



Datasheet

Part No:
FXUB50.A.07.C.001

Description

Wide Band 4x4 MIMO Flex PCB Antenna covering 600MHz to 8GHz

Features:

Low-profile Flexible Polymer Antenna
4* LTE MIMO Configuration
Covering 600MHz to 8000MHz
Coaxial Cables: 150mm of 1.37mm
Connector: I-PEX MHFI (U.FL)
Dimensions: 150 x 150 x 0.24mm

RoHS & Reach Compliant

1.	Introduction	3
2.	Specification	4
3.	Mechanical Drawing	7
4.	Packaging	8
5.	Antenna Characteristics (Inner)	9
6.	Antenna Characteristics (Outer)	13
7.	Radiation Patterns (Inner)	17
8.	Radiation Patterns (Outer)	55
<hr/>		
	Changelog	92

Taoglas makes no warranties based on the accuracy or completeness of the contents of this document and reserves the right to make changes to specifications and product descriptions at any time without notice. Taoglas reserves all rights to this document and the information contained herein. Reproduction, use or disclosure to third parties without express permission is strictly prohibited.



1. Introduction

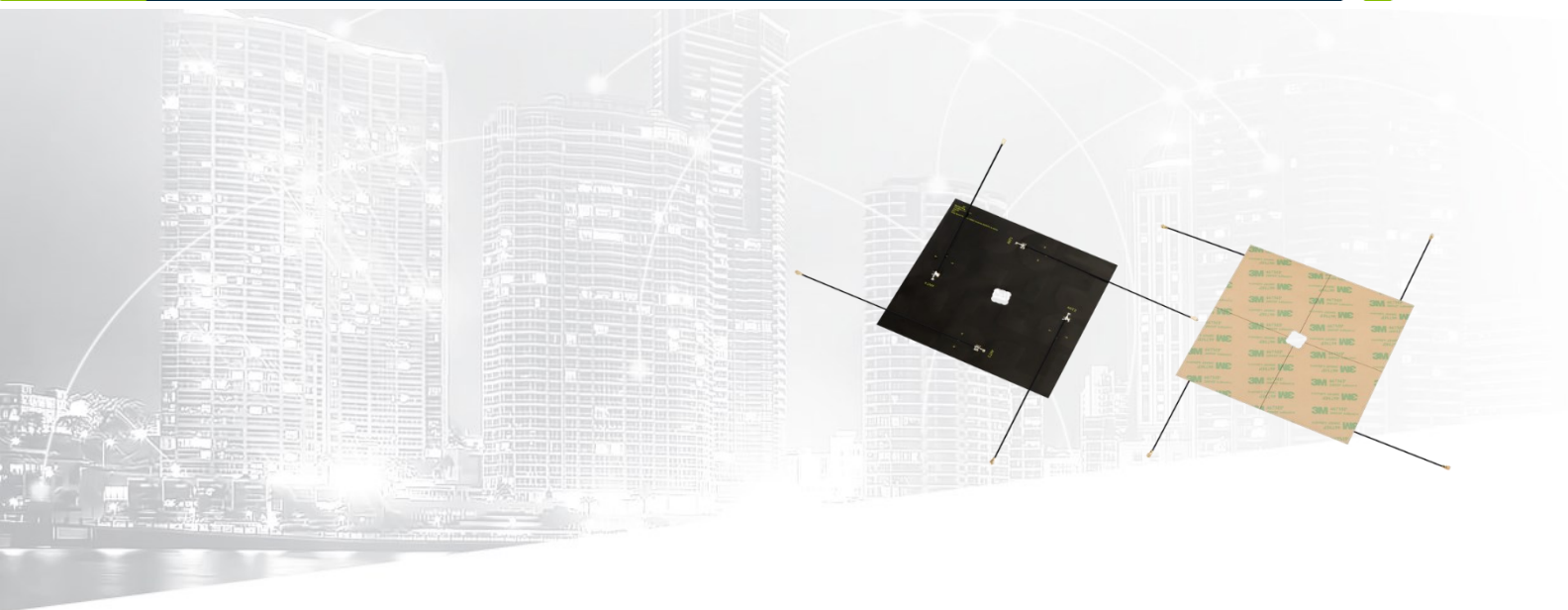

The Taoglas FXUB50 is a flexible wide-band 4x4 MIMO cellular antenna engineered to operate across the 600MHz-8000MHz frequency spectrum. It encompasses Cellular, 2.4/5.8/7.125GHz Wi-Fi, ISM, UWB, and AGPS bands. The high-efficiency antenna is designed for installation flexibility, which is perfect for IoT devices requiring MIMO coverage across all cellular bands.

Typical use cases for the FXUB50 MIMO series of antennas include:

- Healthcare and medical devices
- Industrial IoT applications
- Smart home and electronics
- Smart city asset and sensor monitoring
- Connected vehicles and fleet management.
- Energy and environmental monitoring

Key features and specifications of the FXUB50 include:

- **Efficiency and Design:** Exhibits high efficiency across all bands and is ground plane independent. The flexible polymer body measures 90x90x0.2mm, ensuring an ultra-thin form factor.
- **Installation:** Utilizes a simple “peel and stick” installation process via 3M adhesive, adhering securely to non-metal surfaces.
- **High-performance:** Achieves a peak gain of up to 7.89 dBi and an efficiency of up to 80.1%.
- **Mounting:** The antenna can be mounted directly onto plastic or glass, making it suitable for cost-effective manufacturing and ease-of-assembly in IoT devices.
- **Cable and Connector:** Supplied with 1.37mm micro coax cables and I-PEX MHF1 connectors as standard for straightforward installation. Cables can be routed from the flex PCB or routed through the central aperture, depending on installation requirements. Cables and connectors are customizable to meet specific installation needs.
- **Clearance Requirements:** For optimal radiation efficiency, the antenna should be mounted at least 10mm away from metal components or surfaces, with 20mm being ideal.

For more information on the FXUB50 antenna or to request samples, reach out to your local customer services team or visit www.taoglas.com.

2. Specification

LTE Electrical – Results for Inner Cable Routing Mounting Method									
Band	Frequency (MHz)	Measurement	Efficiency (%)	Average Gain (dB)	Peak Gain (dBi)	Impedance	Polarization	Radiation Pattern	Max. input power
5G NR/4G Band 71	617-698	Antenna 1	43.9	-3.58	0.84	50 Ω	Linear	Omni	5W
		Antenna 2	39.8	-4.00	0.02				
		Antenna 3	46.6	-3.31	-0.09				
		Antenna 4	42.0	-3.77	0.61				
4G/3G Band 12,13,14,17,28,29	698-806	Antenna 1	51.0	-2.92	1.26				
		Antenna 2	44.1	-3.55	0.22				
		Antenna 3	49.5	-3.05	0.98				
		Antenna 4	55.6	-2.55	1.41				
4G/3G/NB-IoT/Cat M Band 5,8,18,19,20,26,27	824-960	Antenna 1	57.4	-2.41	2.25				
		Antenna 2	55.9	-2.52	2.00				
		Antenna 3	52.0	-2.84	2.11				
		Antenna 4	48.5	-3.15	1.82				
5G NR/4G Band 21,32,74,75,76	1427-1518	Antenna 1	52.9	-2.76	2.35				
		Antenna 2	46.5	-3.33	1.92				
		Antenna 3	49.2	-3.08	2.73				
		Antenna 4	49.7	-3.04	2.74				
4G/3G Band 1,2,3,4,9,23,25,35,39,66	1710-2200	Antenna 1	72.0	-1.43	4.22				
		Antenna 2	71.7	-1.45	4.11				
		Antenna 3	73.0	-1.37	4.24				
		Antenna 4	73.2	-1.35	6.07				
4G/3G Band 7,30,38,40,41	2300-2690	Antenna 1	77.7	-1.09	3.58				
		Antenna 2	71.9	-1.43	3.53				
		Antenna 3	77.0	-1.13	4.14				
		Antenna 4	80.1	-0.96	4.02				
5G NR/4G Band 22,42,48,77,78,79	3300-5000	Antenna 1	66.5	-1.77	6.71				
		Antenna 2	65.2	-1.86	7.89				
		Antenna 3	67.3	-1.72	6.60				
		Antenna 4	73.0	-1.37	6.92				
LTE5200/Wi-Fi5800	5150-5925	Antenna 1	48.7	-3.12	4.47				
		Antenna 2	51.1	-2.92	5.45				
		Antenna 3	60.7	-2.17	5.52				
		Antenna 4	68.5	-1.64	5.83				
Wi-Fi - 6GHz	5925-7125	Antenna 1	50.6	-2.96	5.70				
		Antenna 2	48.4	-3.15	5.35				
		Antenna 3	57.7	-2.39	5.60				
		Antenna 4	64.4	-1.91	5.89				

LTE Electrical – Results for Outer Cable Routing Mounting Method									
Band	Frequency (MHz)	Measurement	Efficiency (%)	Average Gain (dB)	Peak Gain (dBi)	Impedance	Polarization	Radiation Pattern	Max. input power
5G NR/4G Band 71	617-698	Antenna 1	38.5	-4.15	0.06	50 Ω	Linear	Omni	5W
		Antenna 2	38.6	-4.14	0.01				
		Antenna 3	38.2	-4.18	-0.52				
		Antenna 4	39.0	-4.09	-0.18				
4G/3G Band 12,13,14,17,28,29	698-806	Antenna 1	55.6	-2.55	1.34				
		Antenna 2	56.8	-2.46	1.53				
		Antenna 3	55.5	-2.56	1.23				
		Antenna 4	56.0	-2.52	1.36				
4G/3G/NB-IoT/Cat M Band 5,8,18,19,20,26,27	824-960	Antenna 1	58.0	-2.36	2.04				
		Antenna 2	57.3	-2.42	2.12				
		Antenna 3	60.6	-2.18	2.20				
		Antenna 4	56.2	-2.50	2.17				
5G NR/4G Band 21,32,74,75,76	1427-1518	Antenna 1	48.3	-3.16	5.00				
		Antenna 2	49.0	-3.10	5.23				
		Antenna 3	50.9	-2.93	4.73				
		Antenna 4	50.0	-3.01	5.13				
4G/3G Band 1,2,3,4,9,23,25,35,39,66	1710-2200	Antenna 1	65.8	-1.82	4.27				
		Antenna 2	62.6	-2.04	4.30				
		Antenna 3	65.6	-1.83	4.54				
		Antenna 4	63.8	-1.95	4.45				
4G/3G Band 7,30,38,40,41	2300-2690	Antenna 1	71.4	-1.46	4.98				
		Antenna 2	73.7	-1.33	4.24				
		Antenna 3	71.2	-1.47	4.14				
		Antenna 4	73.2	-1.36	4.69				
5G NR/4G Band 22,42,48,77,78,79	3300-5000	Antenna 1	69.1	-1.60	5.36				
		Antenna 2	63.1	-2.00	4.99				
		Antenna 3	69.8	-1.56	5.54				
		Antenna 4	67.9	-1.68	5.22				
LTE5200/Wi-Fi5800	5150-5925	Antenna 1	71.2	-1.47	4.79				
		Antenna 2	52.2	-2.83	4.49				
		Antenna 3	69.8	-1.56	4.64				
		Antenna 4	68.0	-1.68	4.35				
Wi-Fi - 6GHz	5925-7125	Antenna 1	64.6	-1.90	5.31				
		Antenna 2	61.1	-2.14	5.02				
		Antenna 3	64.4	-1.91	4.90				
		Antenna 4	62.7	-2.03	4.91				

Mechanical	
Dimensions	150x150x0.24mm
Weight	12g
Material	Flexible Polymer
Connector	IPEX U.FL
Cable	4 x 150mm 1.37 Coaxial

Environmental	
Operation Temperature	-40°C to 85°C
Storage Temperature	-40°C to 85°C
RoHs & REACH Compliant	Yes

3. Mechanical Drawing

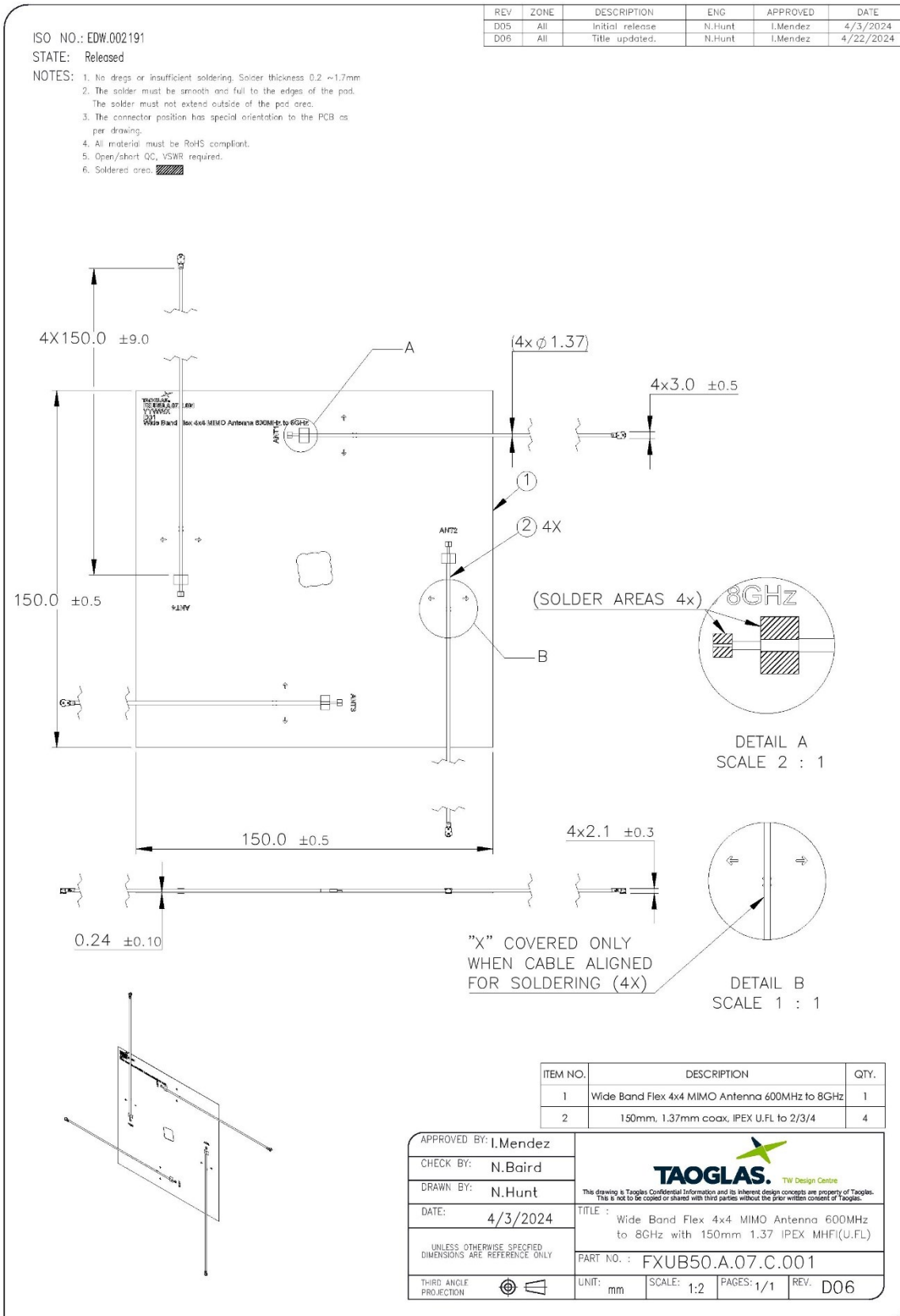

4. Packaging

100pcs FXUB50.A.07.C.001 per PE Bag
 Dimensions – 280x320mm
 Weight – 0.12Kg

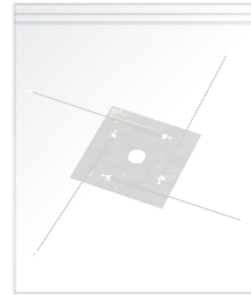

1000pcs FXUB50.A.07.C.001 per carton
 Dimensions – 360x310x160mm
 Weight – 3.1Kg

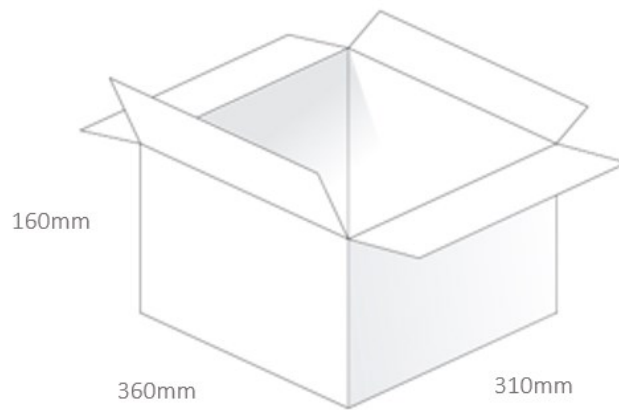

5. Antenna Characteristics (Inner)

The following outlines the antenna characteristics for the FXUB50.A.07.C.001, with cables routed through the center hole of the antenna, as shown in the test setup image below. This configuration is denoted as 'Inner'.

5.1 Test Setup

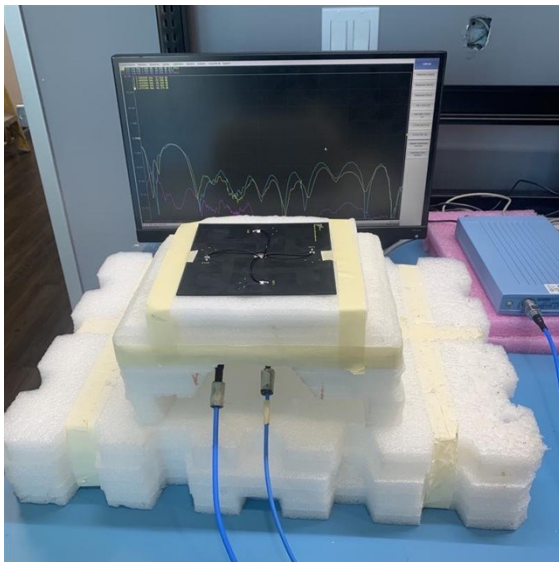
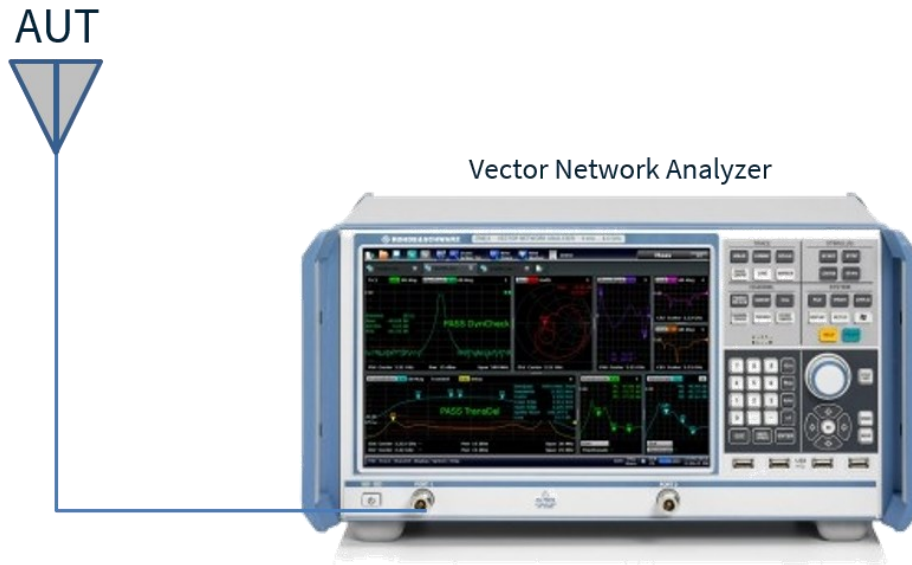

VNA Set-up with cables going through the center of the Antenna

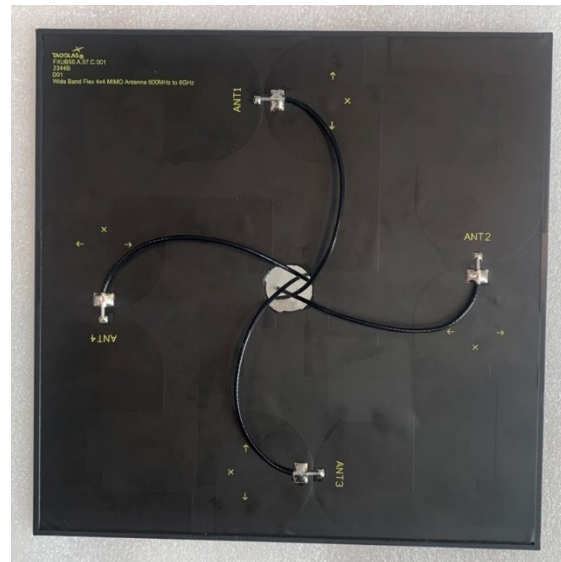

A close up to show the cable routing for the 'Inner' set-up

5.2 Return Loss

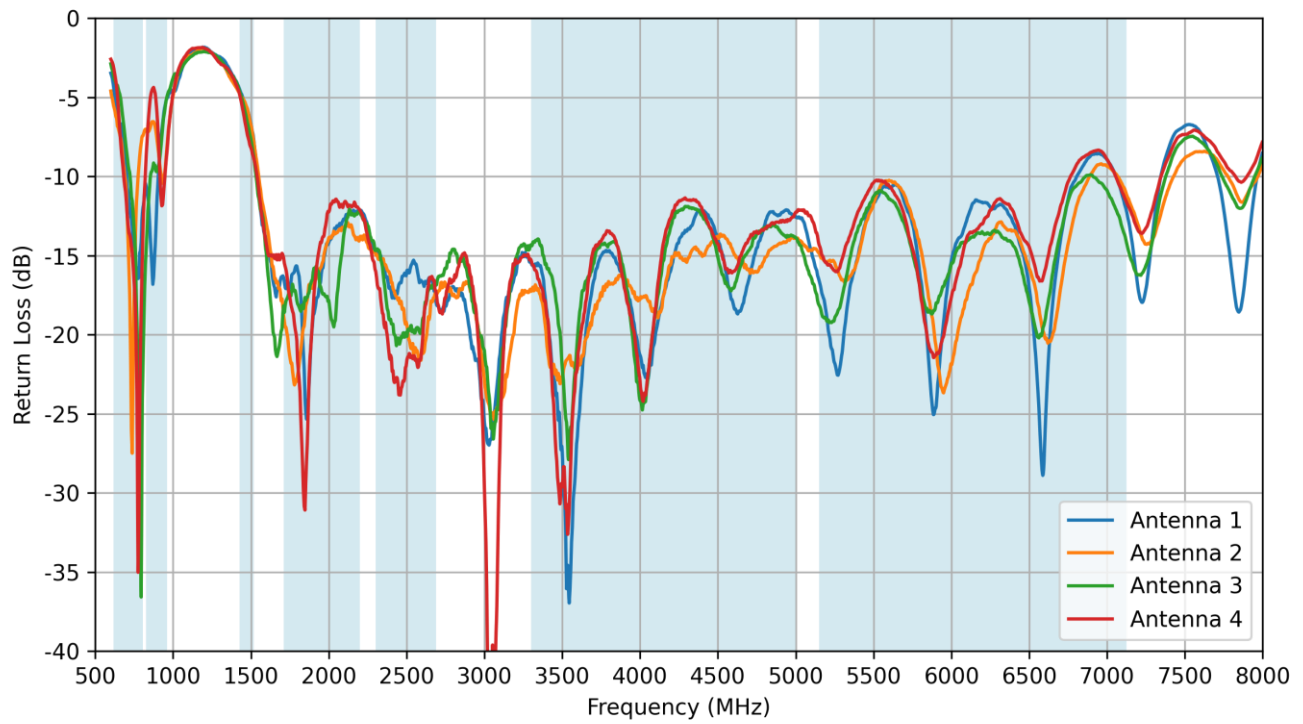

5.3 Isolation

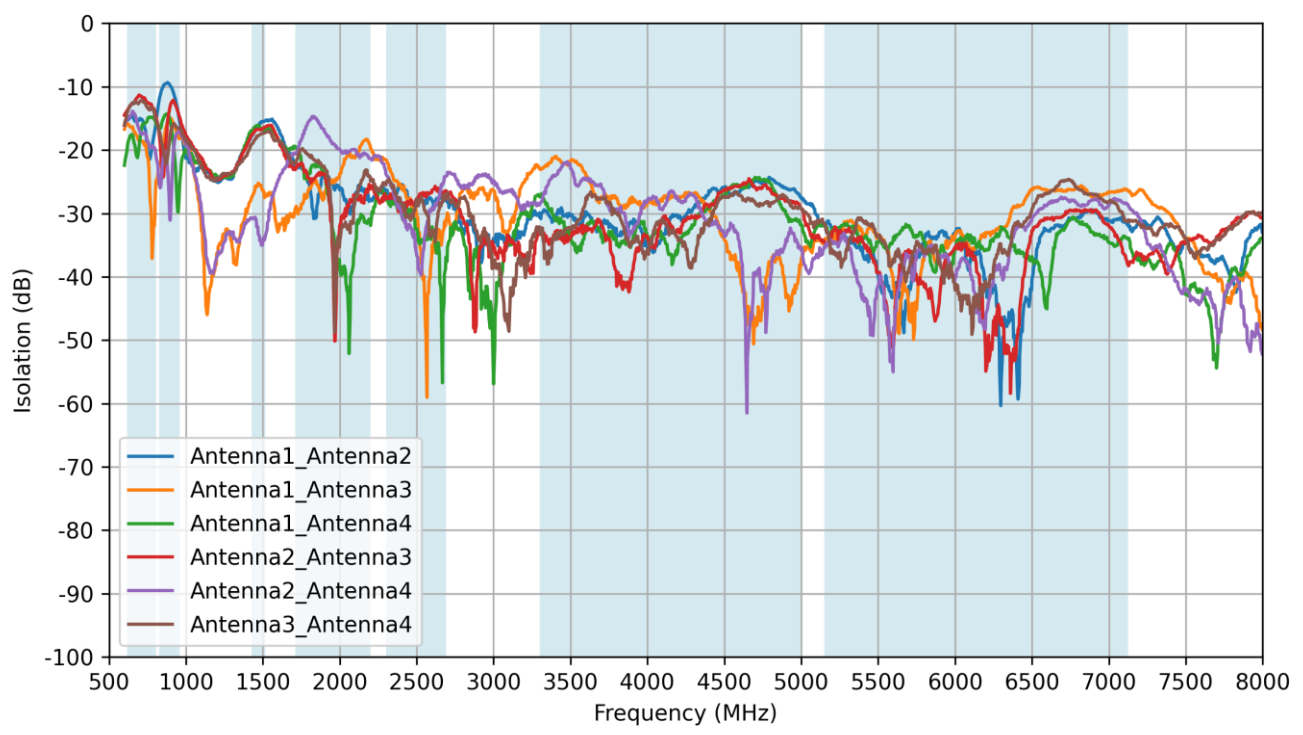

5.4 Efficiency

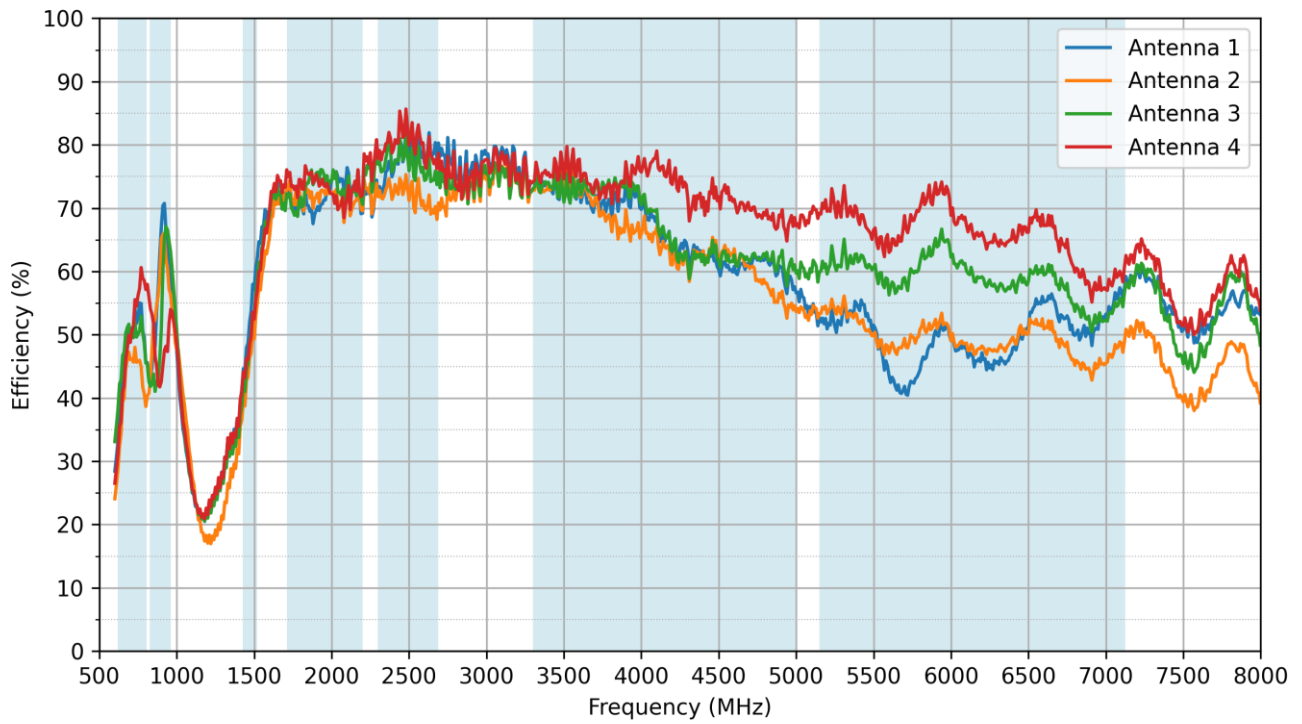

5.5 Average Gain

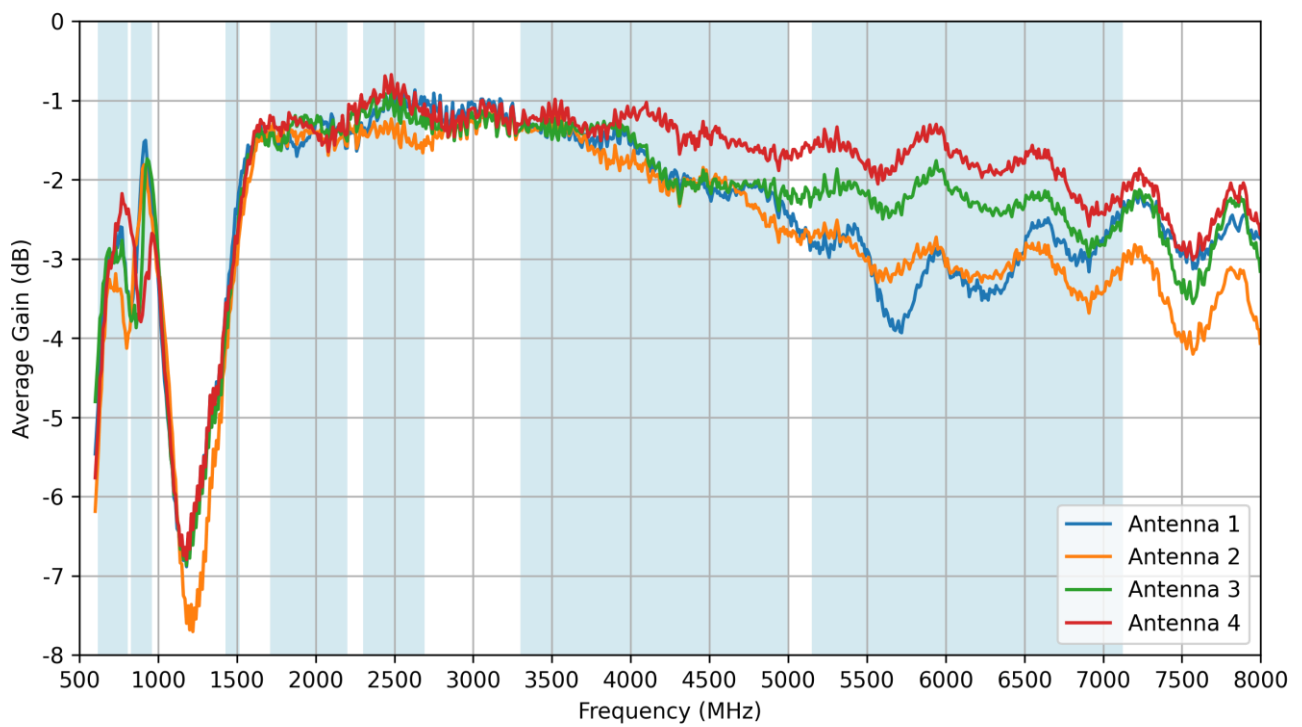

5.6 Peak Gain

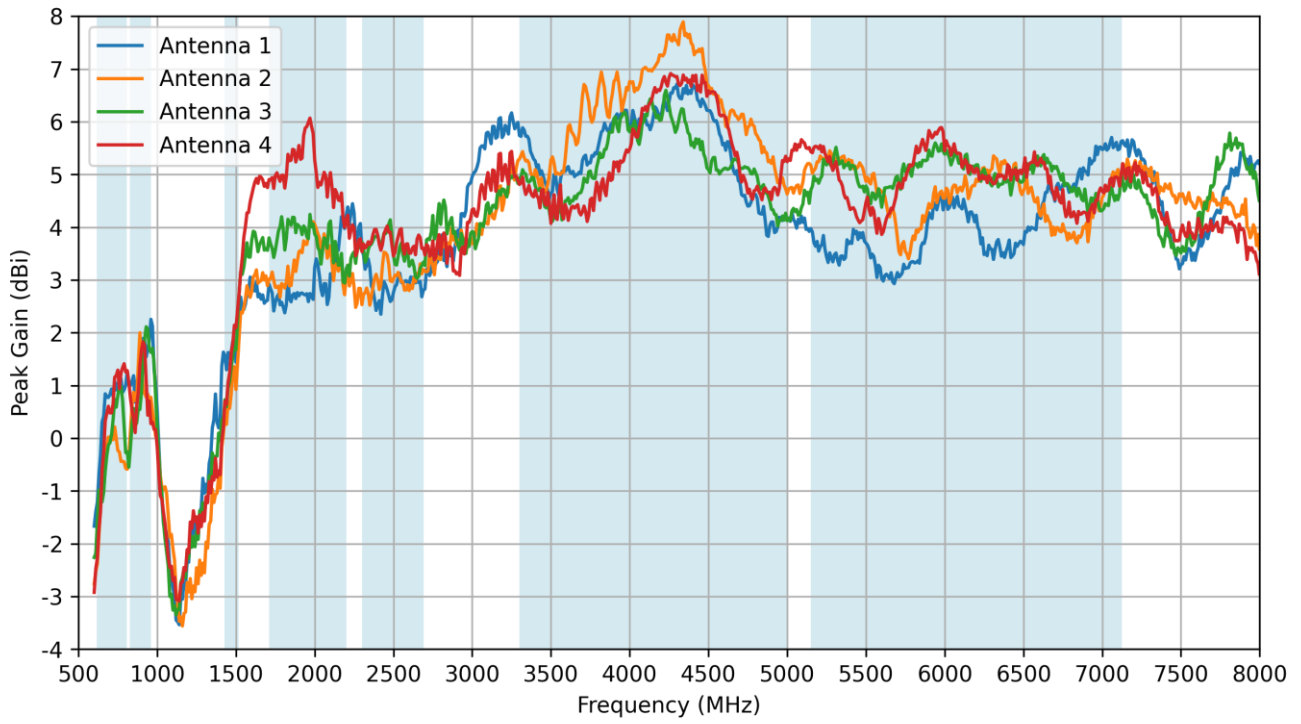

6. Antenna Characteristics (Outer)

The following outlines the antenna characteristics for the FXUB50.A.07.C.001, with cables routed outward away from the antenna, as shown in the test setup image below. This configuration is denoted as 'Outer'.

6.1 Test Setup

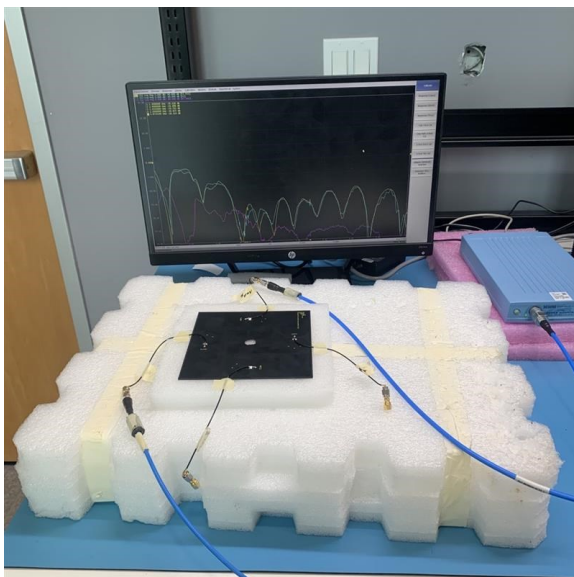
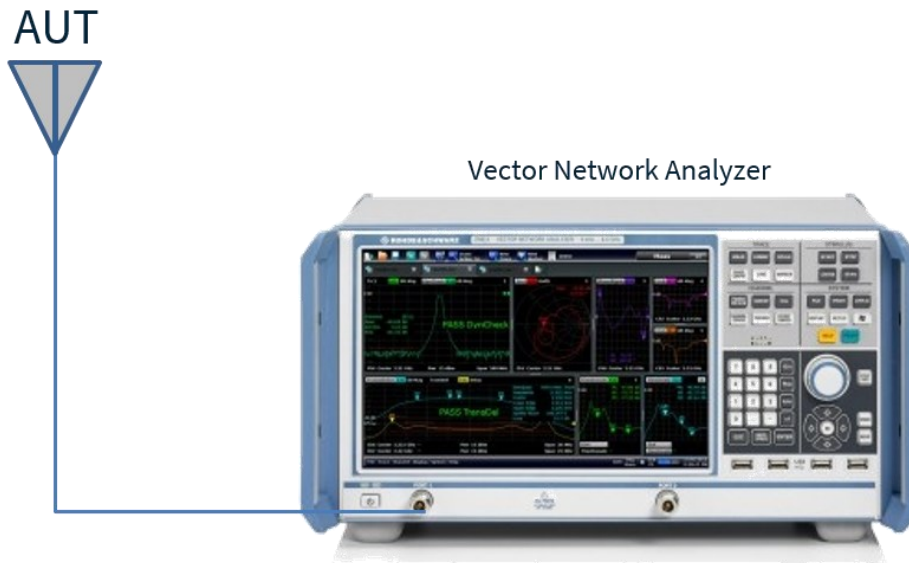

VNA Set-up with cables going Outward away from the Antenna

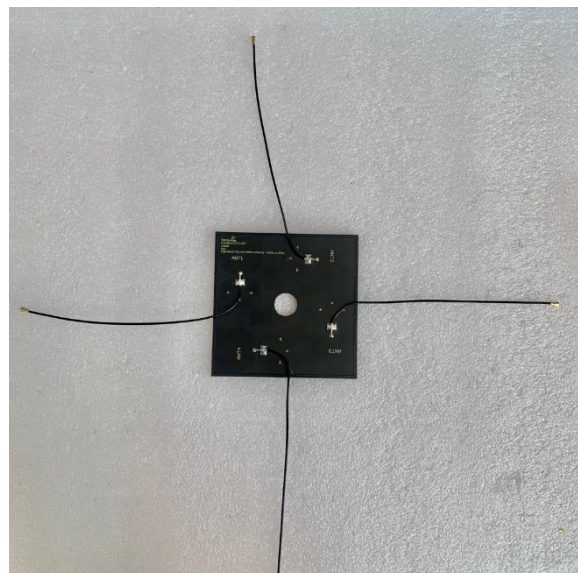

A close up to show the cable routing for the 'Outer' set-up

6.2 Return Loss

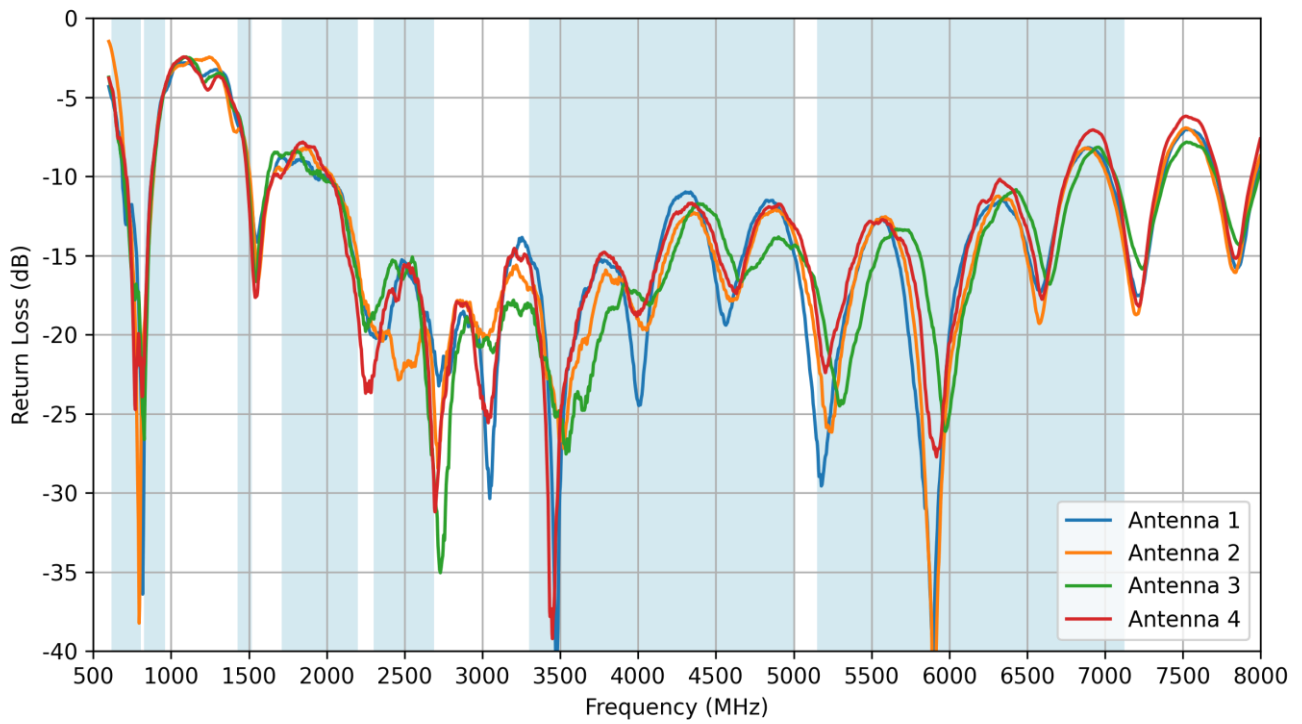

6.3 Isolation

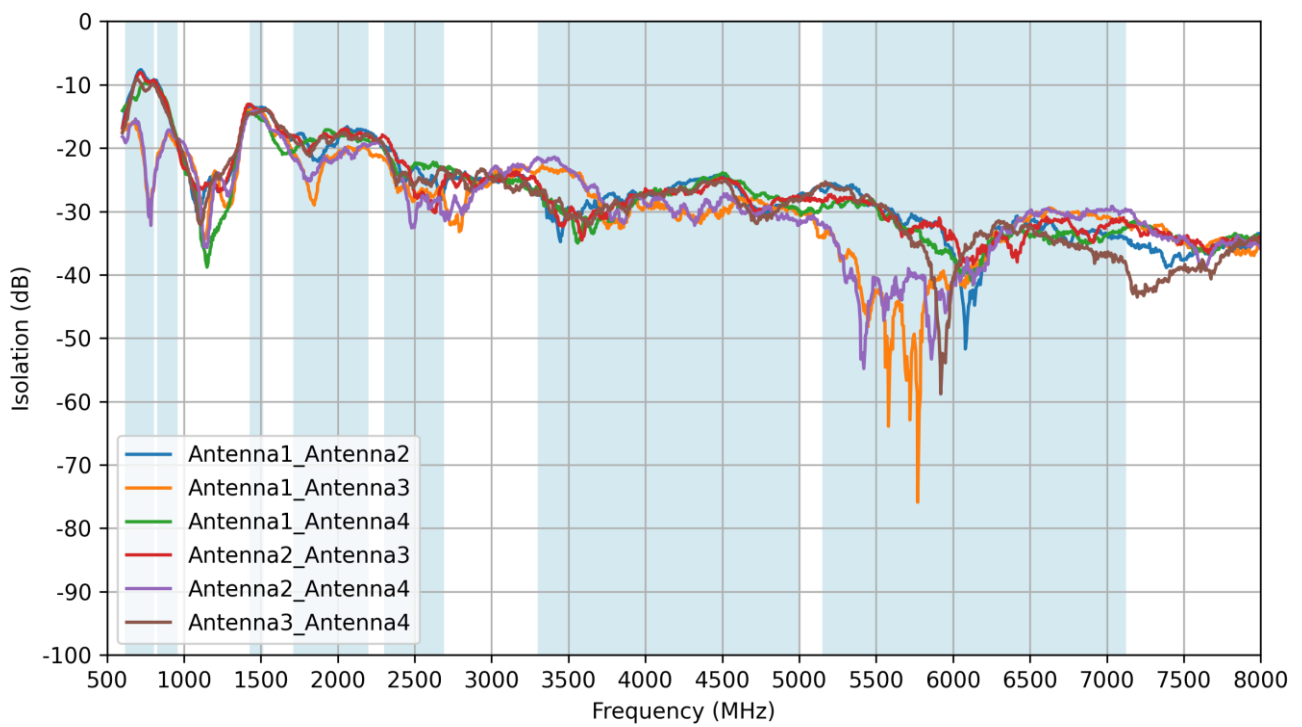

6.4 Efficiency

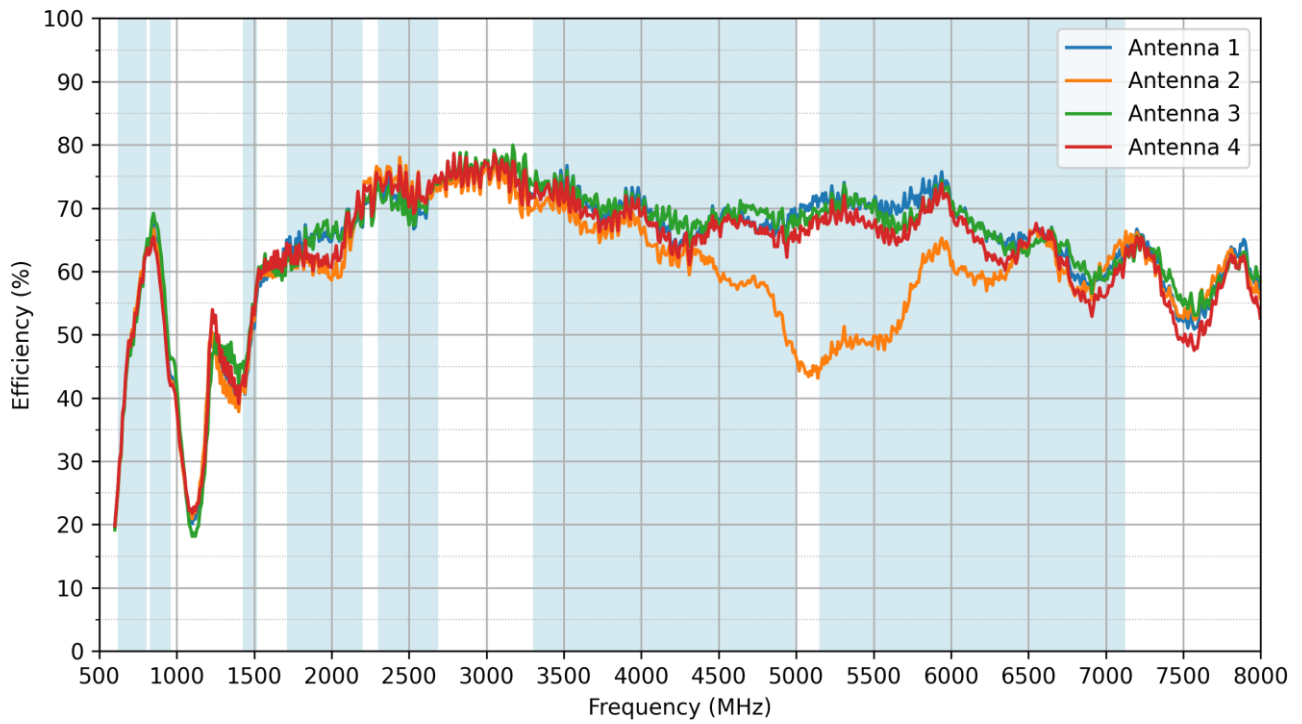

6.5 Average Gain

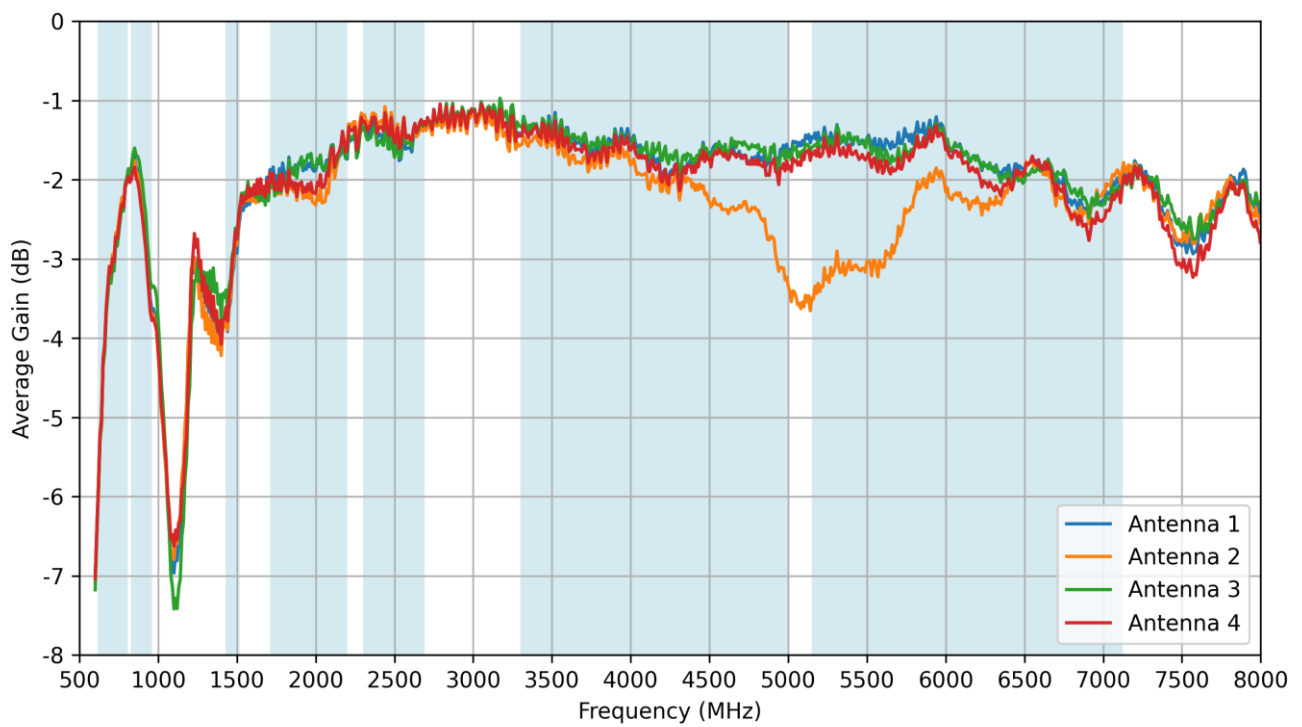

6.6 Peak Gain

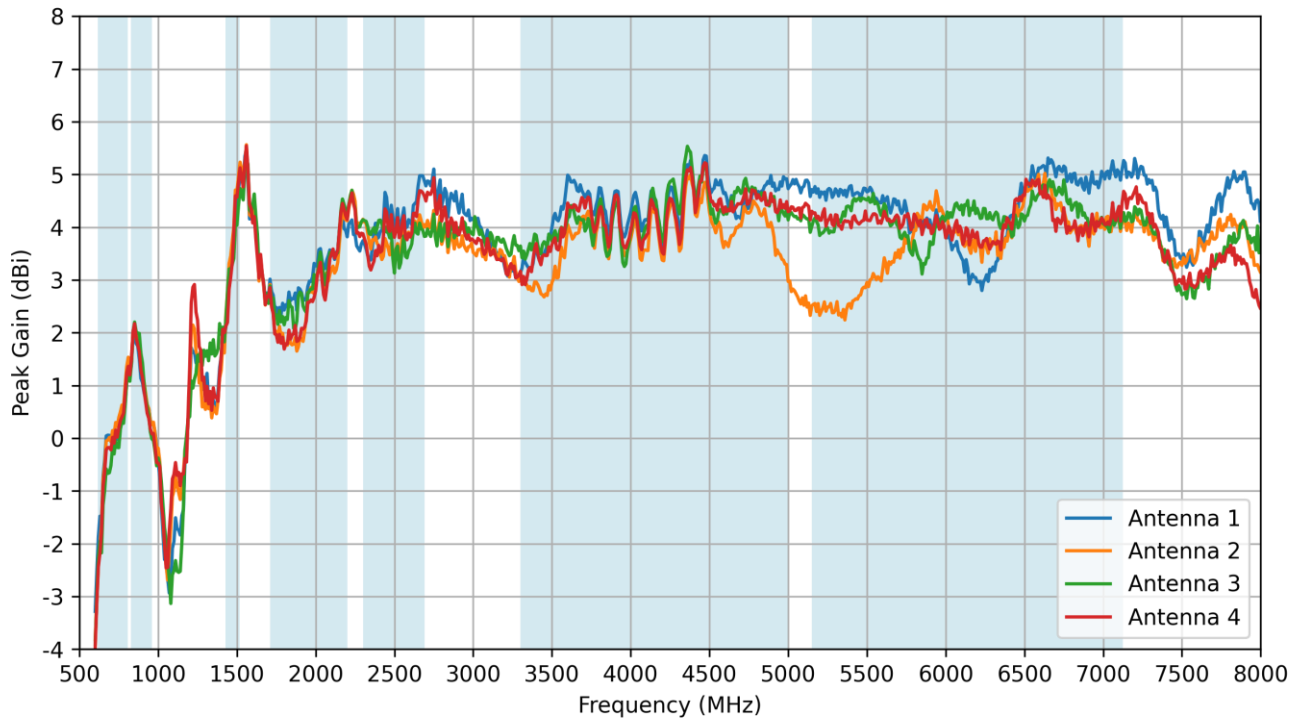

7. Radiation Patterns (Inner)

7.1 Test Setup

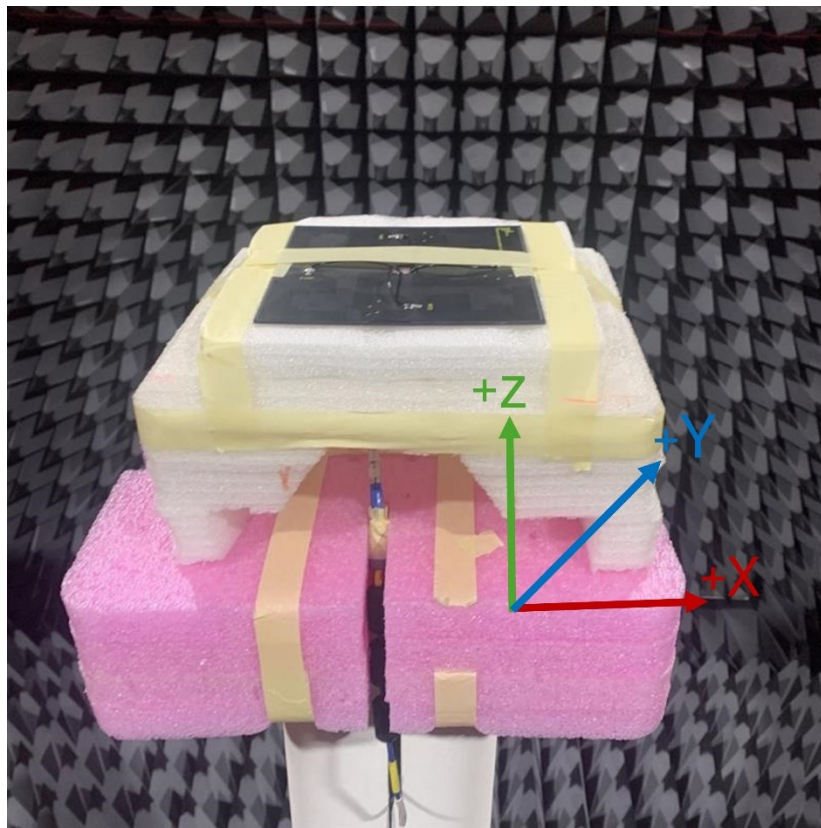
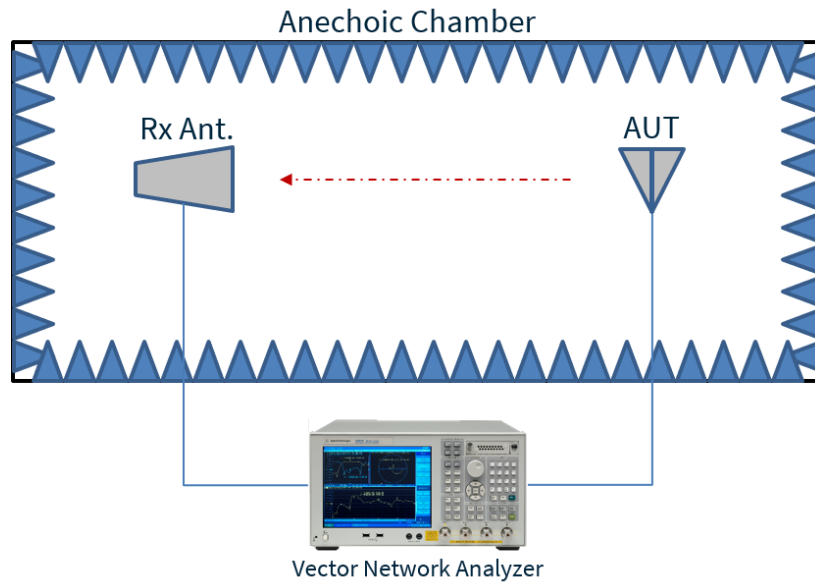

Chamber Set-up with cables going through the center of the Antenna

7.2 Antenna 1 Patterns at 660 MHz

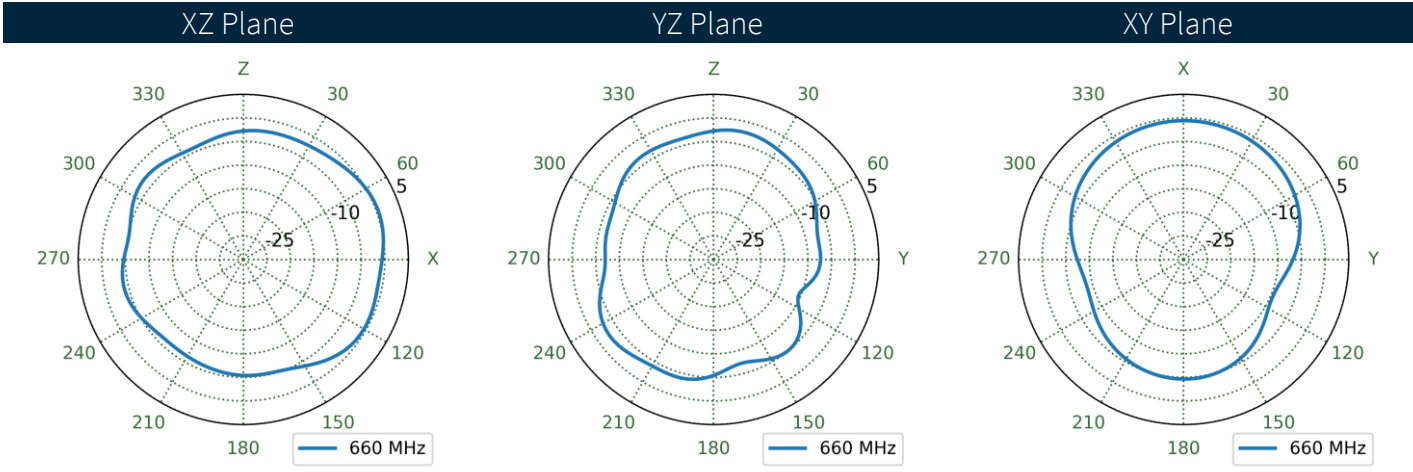
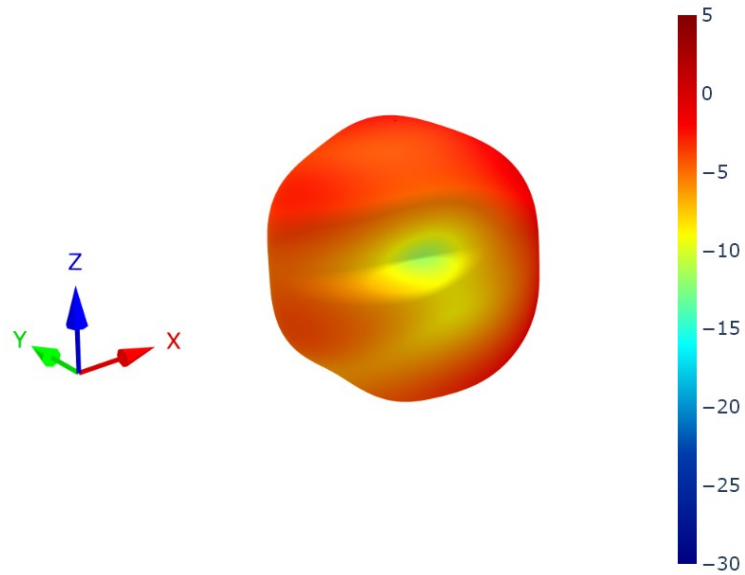

7.3 Antenna 2 Patterns at 660 MHz

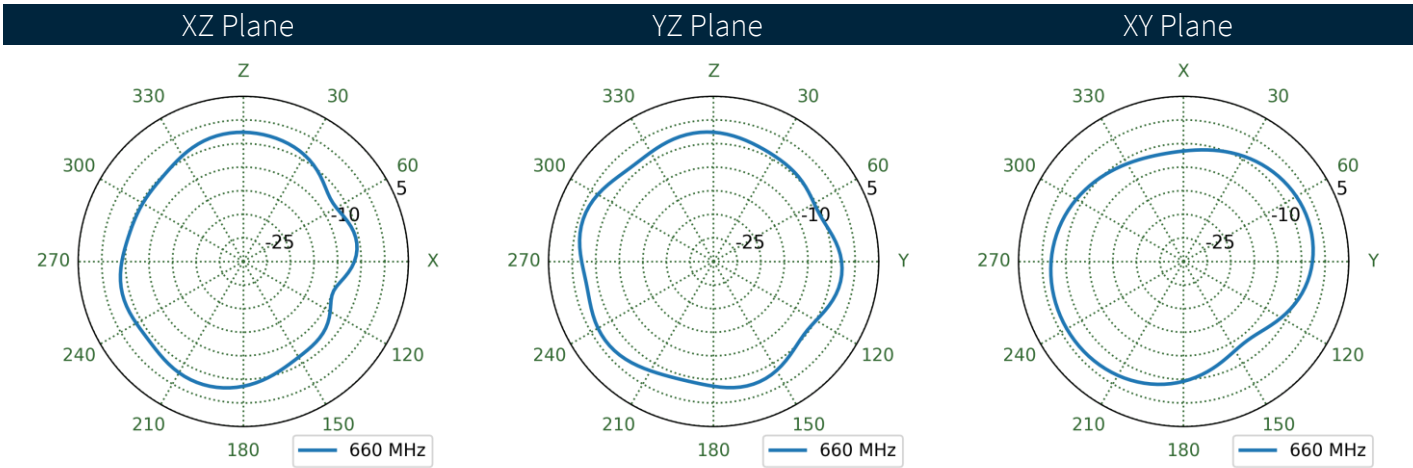
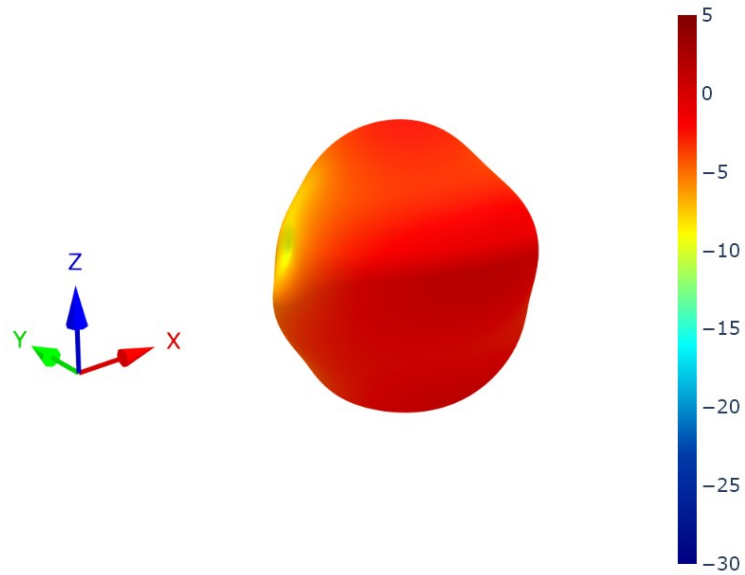

7.4 Antenna 3 Patterns at 660 MHz

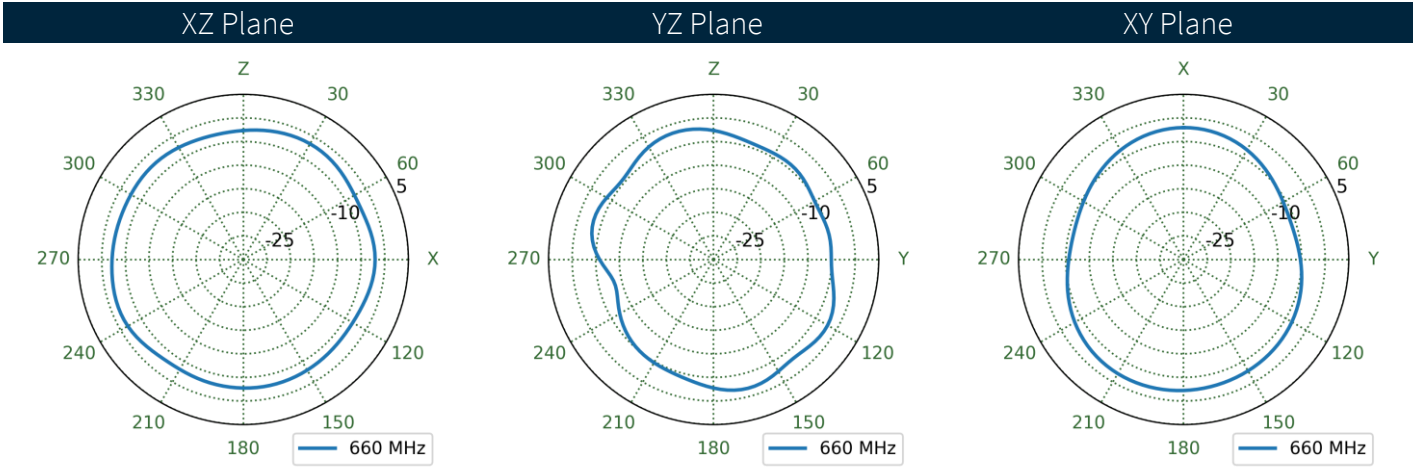
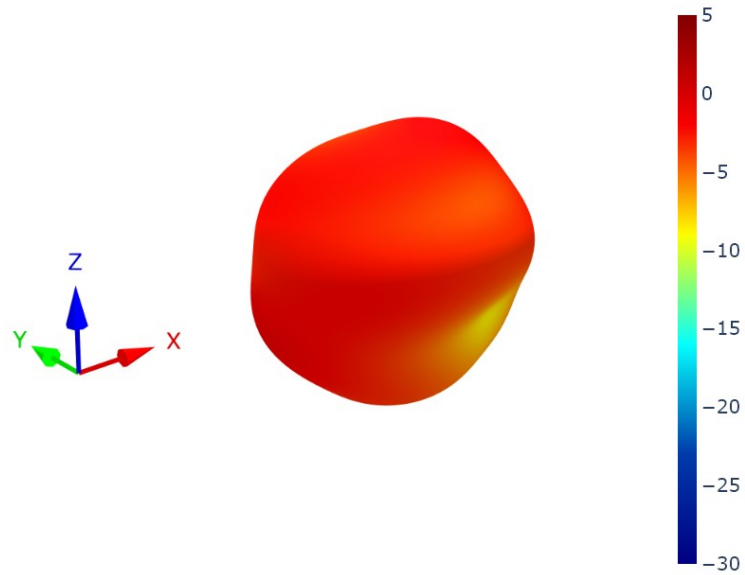

7.5 Antenna 4 Patterns at 660 MHz

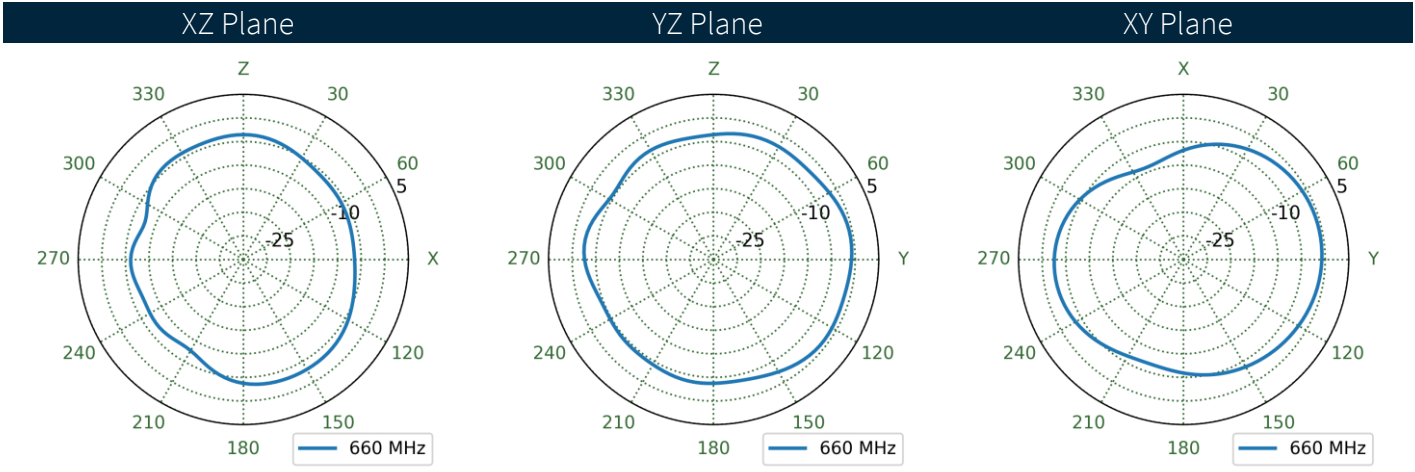
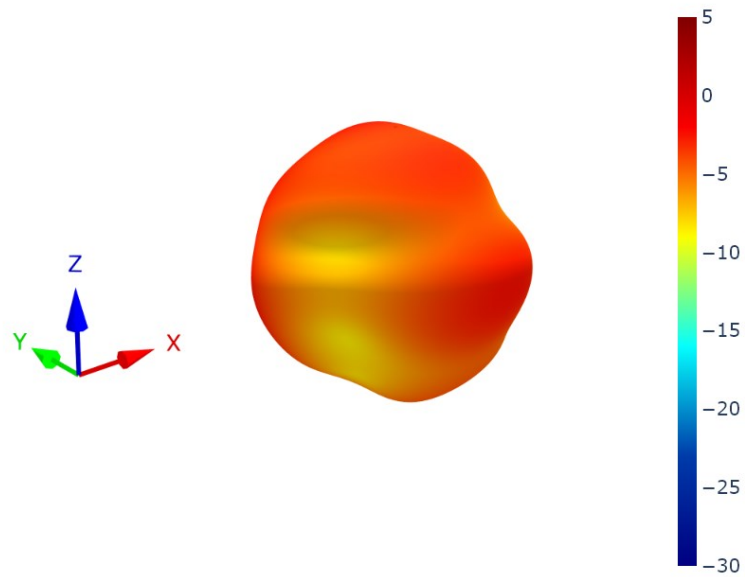

7.6 Antenna 1 Patterns at 750 MHz

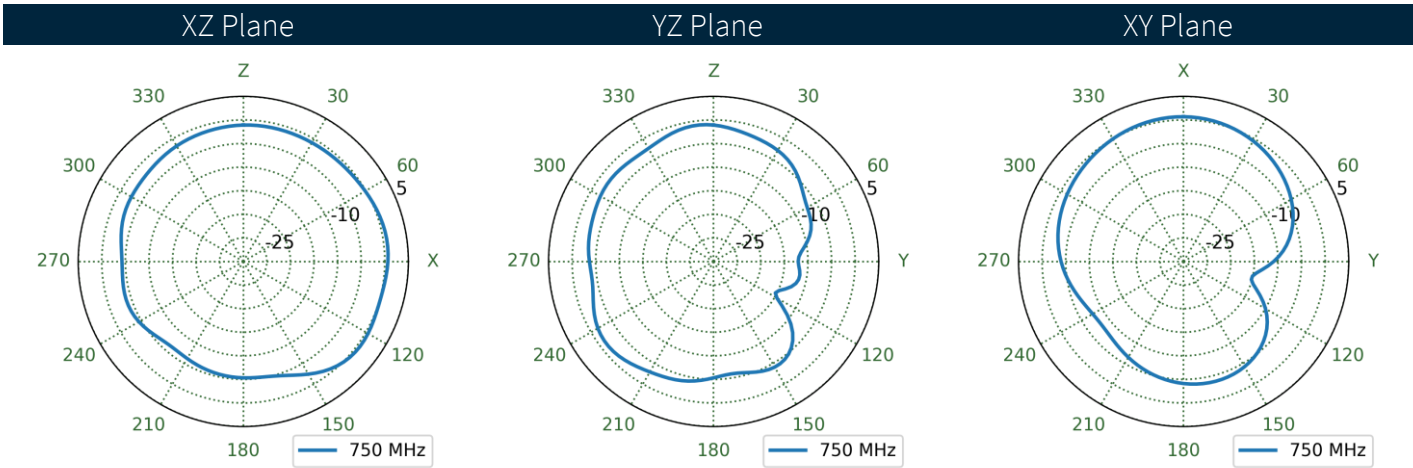
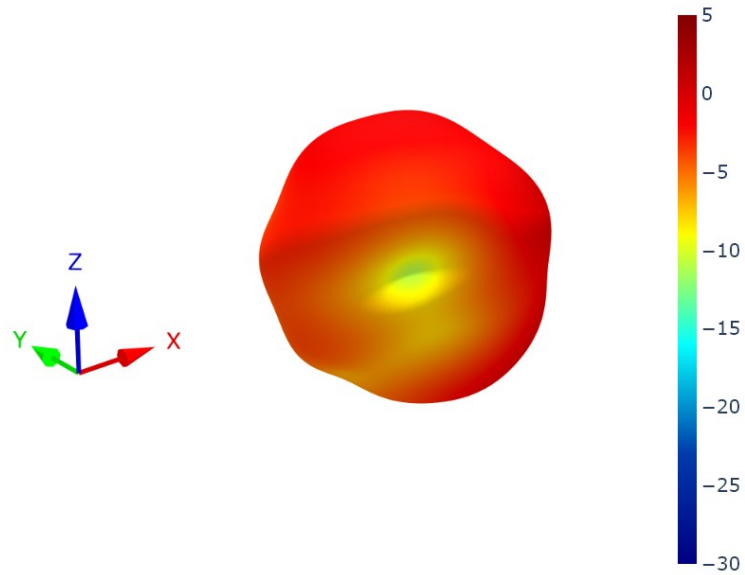

7.7 Antenna 2 Patterns at 750 MHz

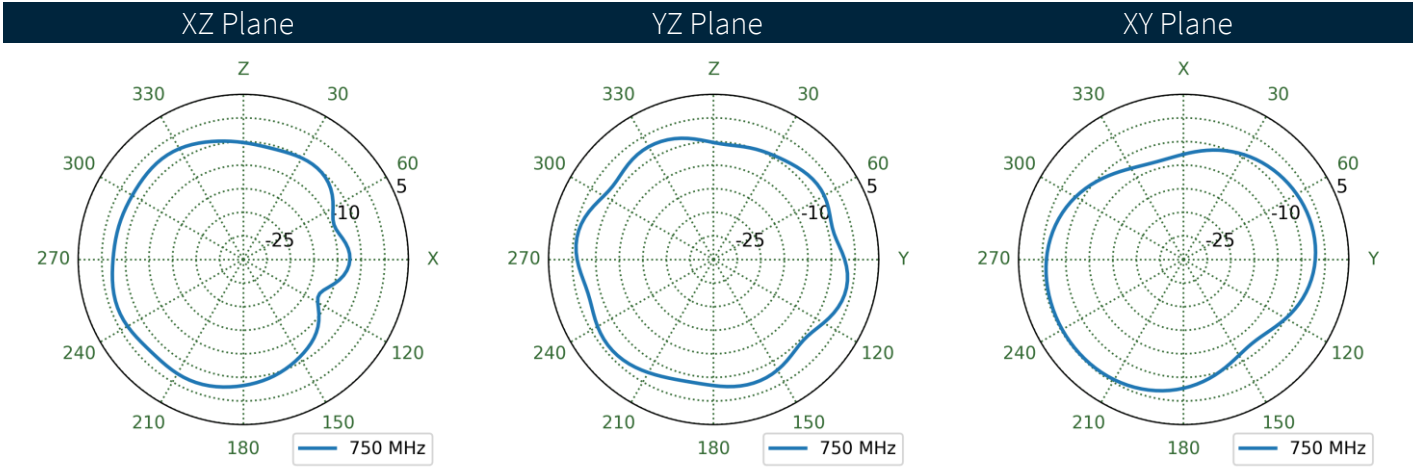
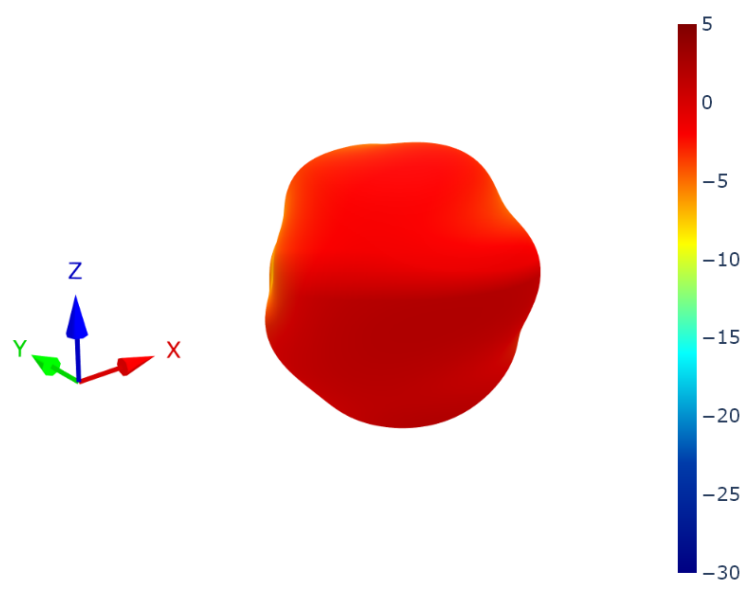

7.8 Antenna 3 Patterns at 750 MHz

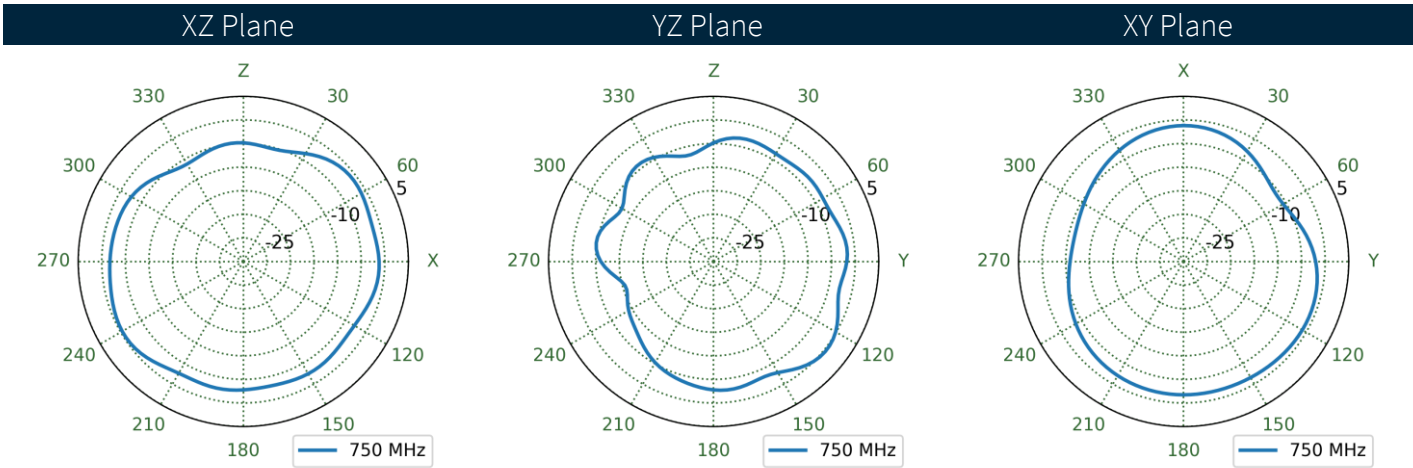
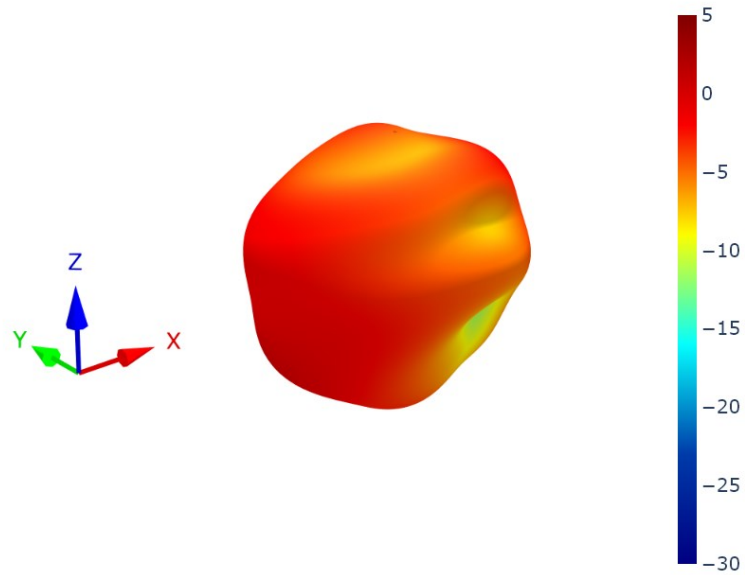

7.9 Antenna 4 Patterns at 750 MHz

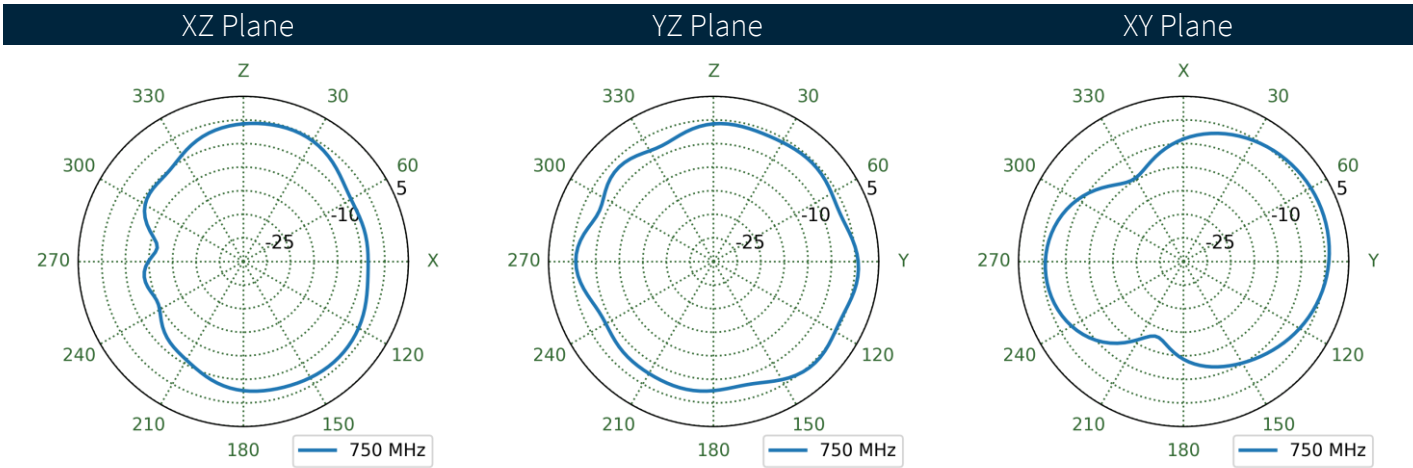
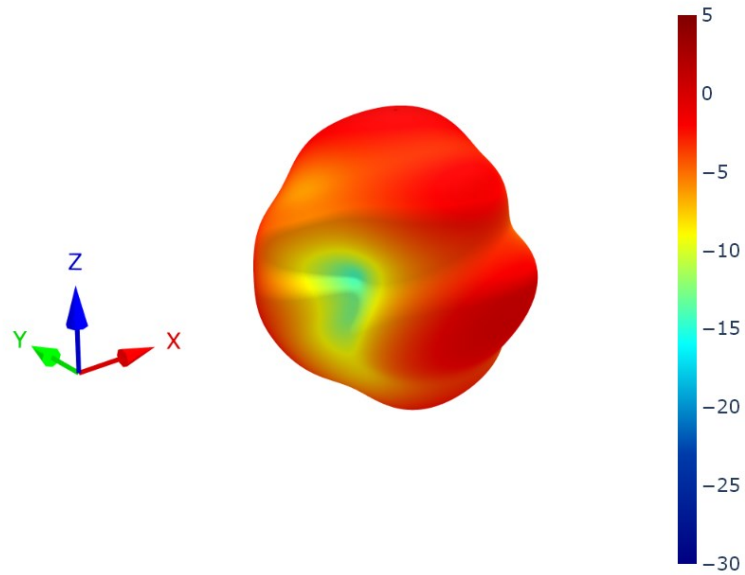

7.10 Antenna 1 Patterns at 890 MHz

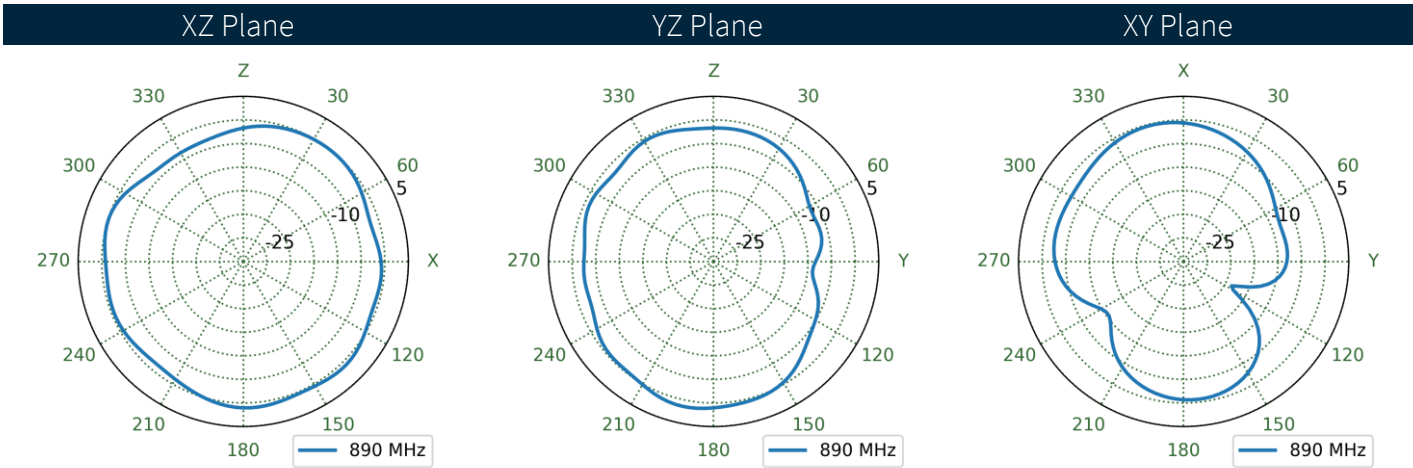
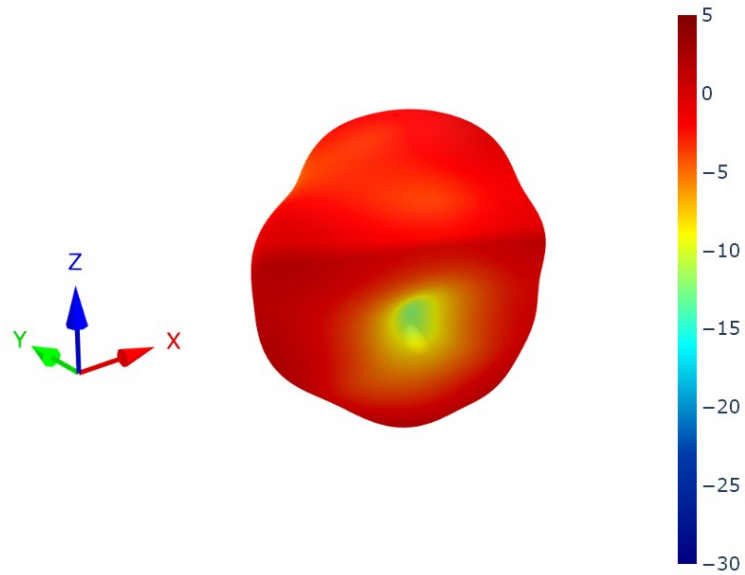

7.11 Antenna 2 Patterns at 890 MHz

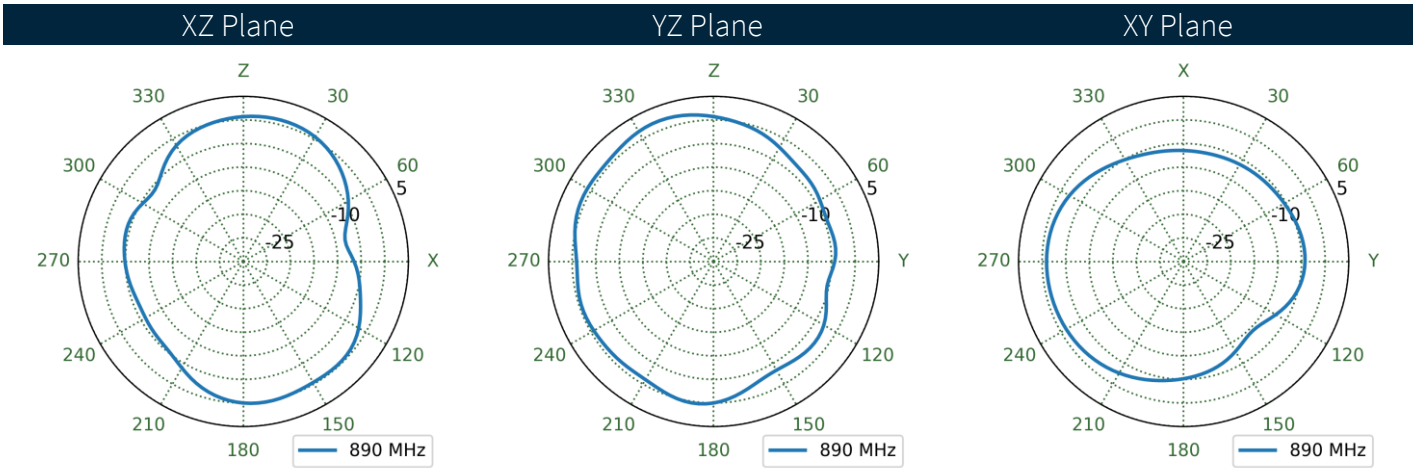
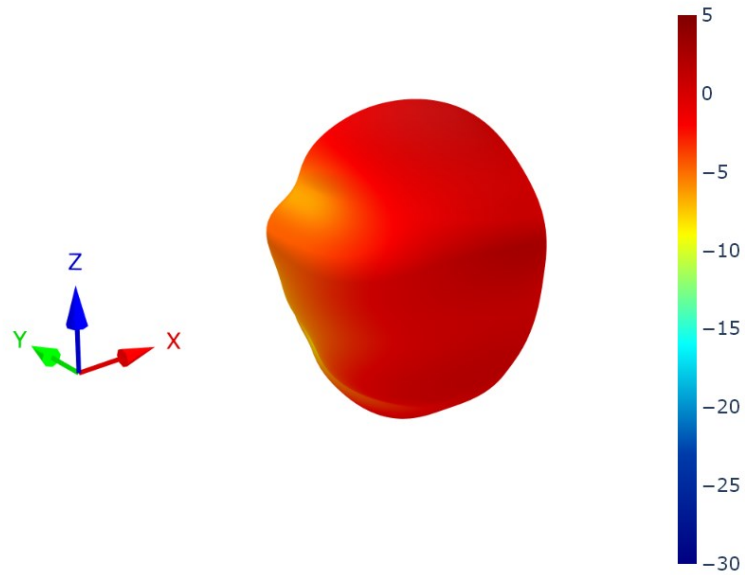

7.12 Antenna 3 Patterns at 890 MHz

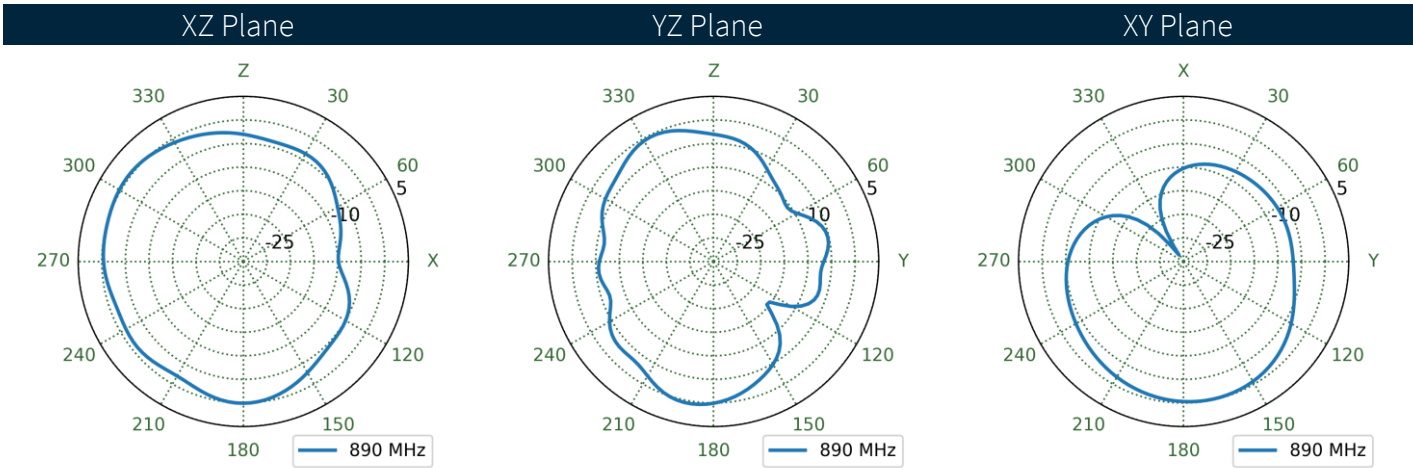
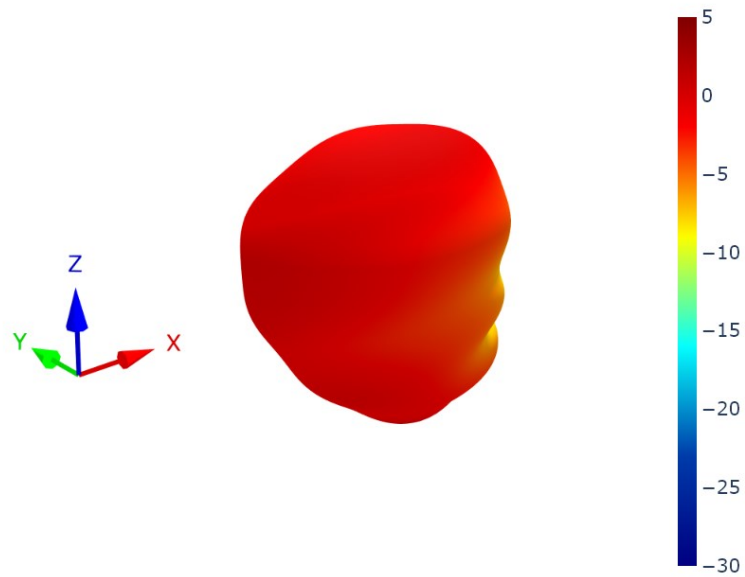

7.13 Antenna 4 Patterns at 890 MHz

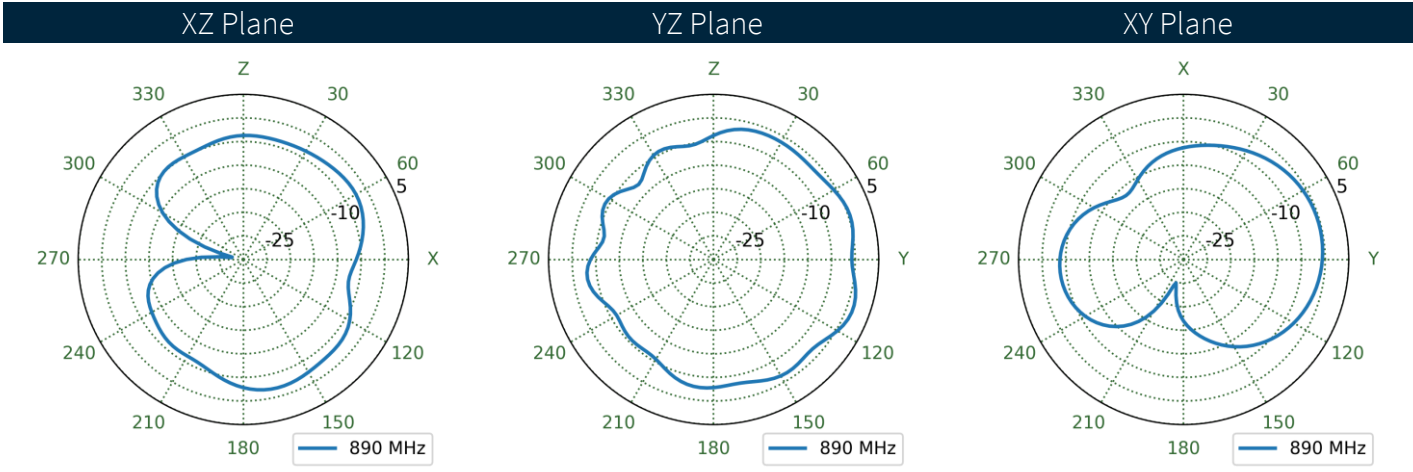
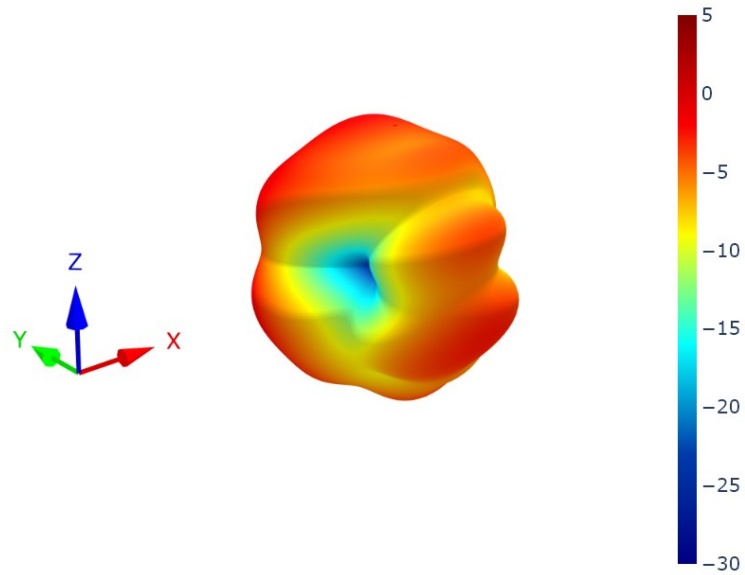

7.14 Antenna 1 Patterns at 1470 MHz

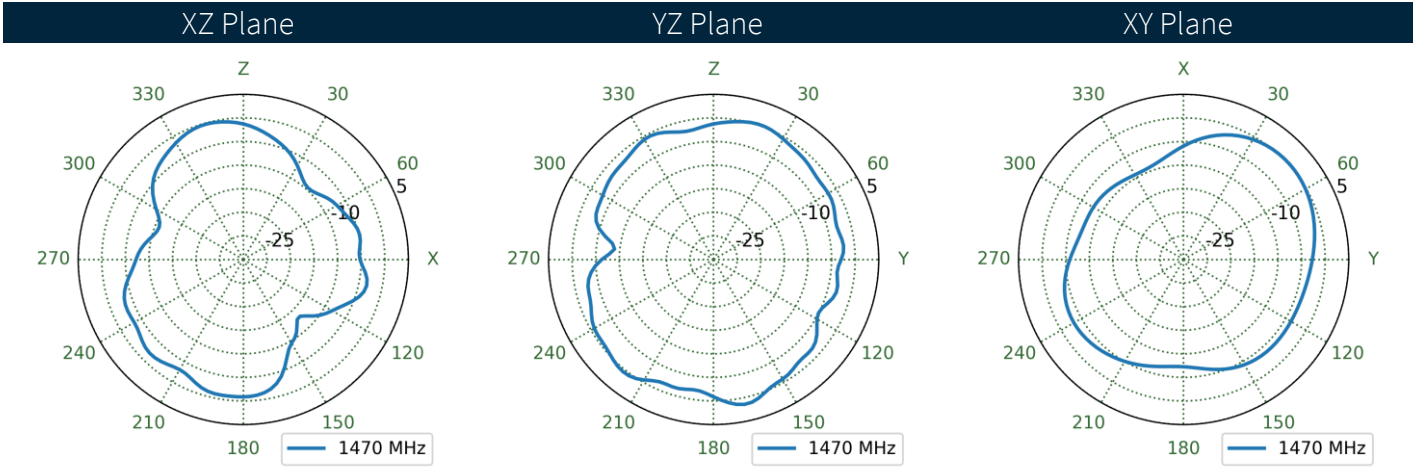
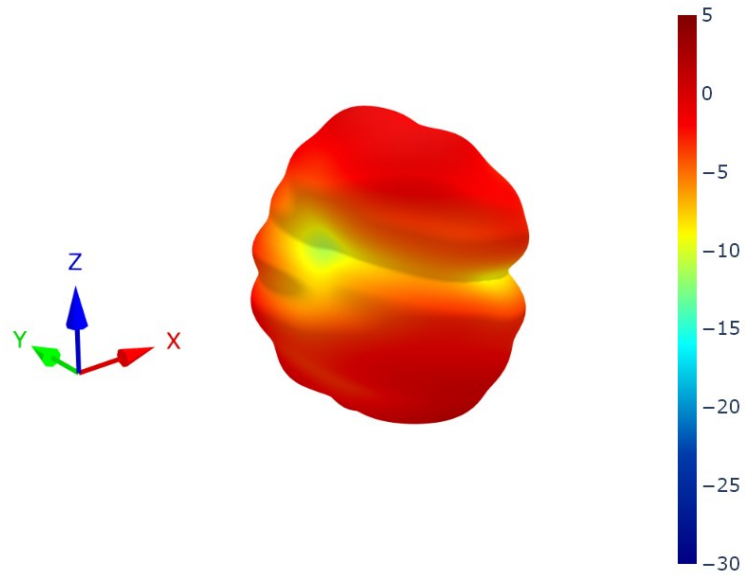

7.15 Antenna 2 Patterns at 1470 MHz

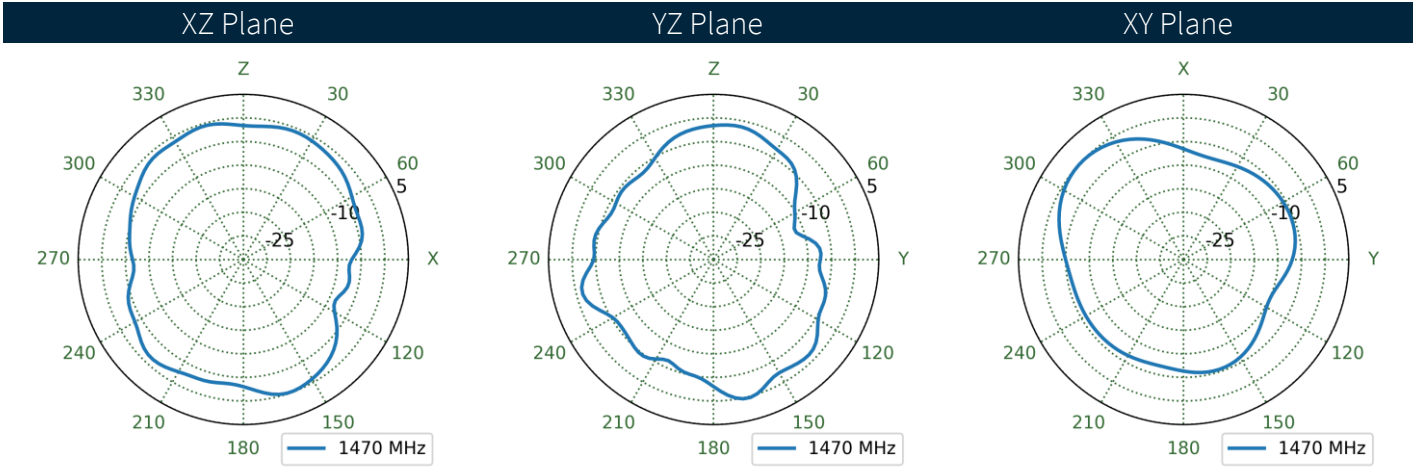
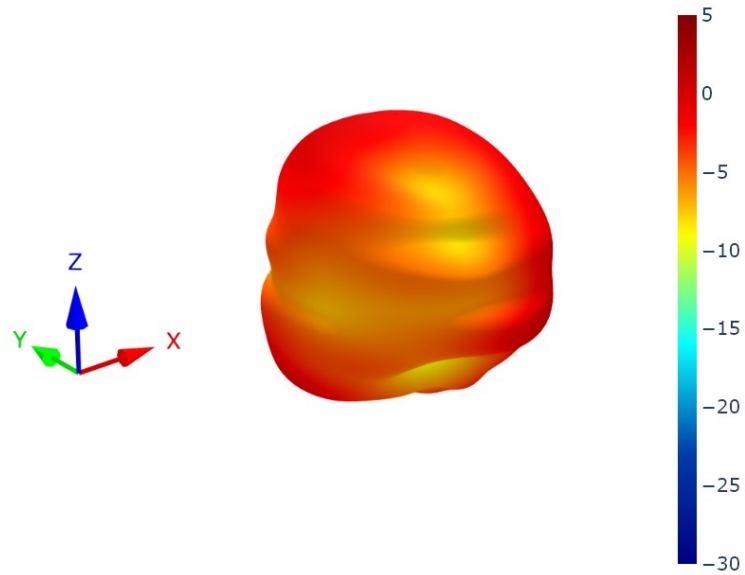

7.16 Antenna 3 Patterns at 1470 MHz

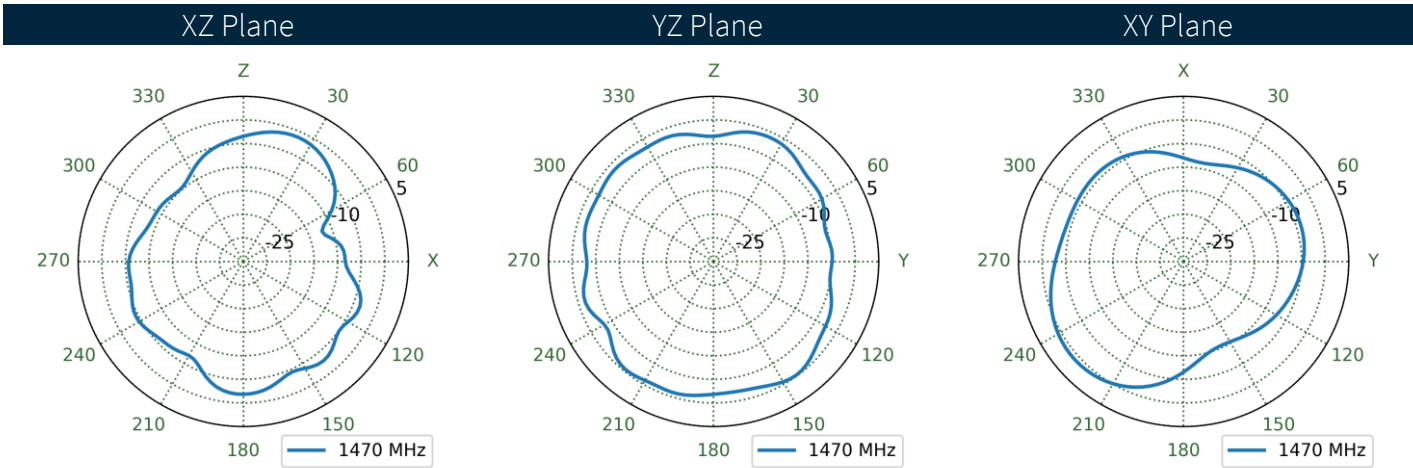
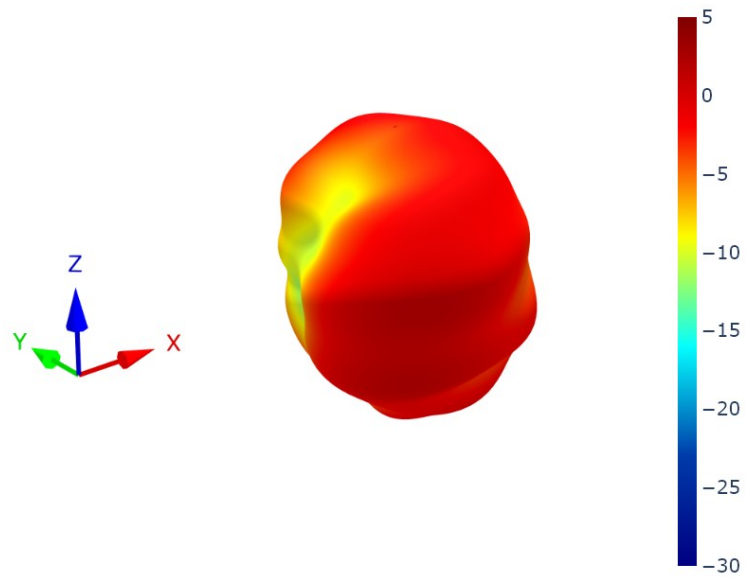

7.17 Antenna 4 Patterns at 1470 MHz

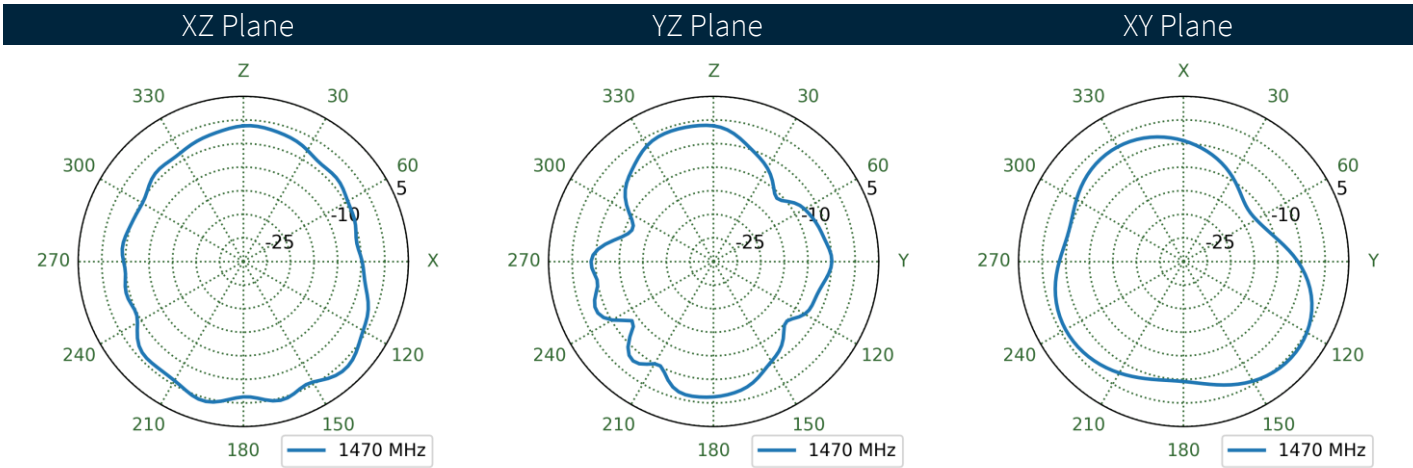
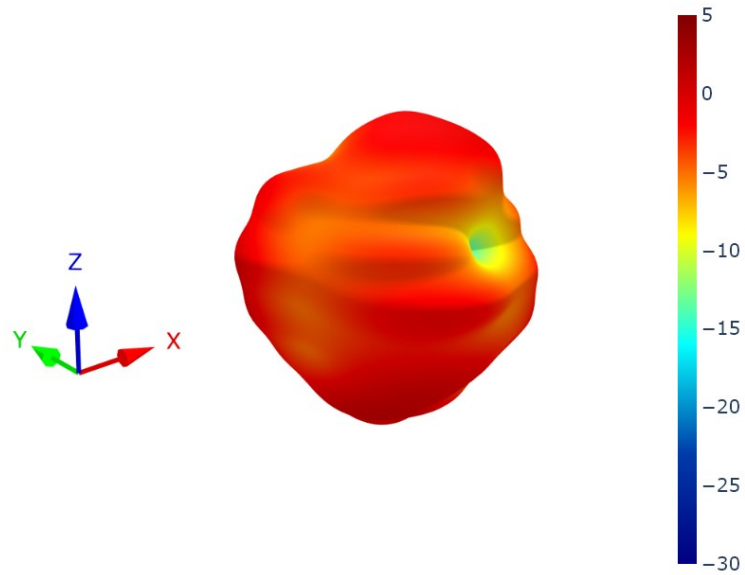

7.18 Antenna 1 Patterns at 1950 MHz

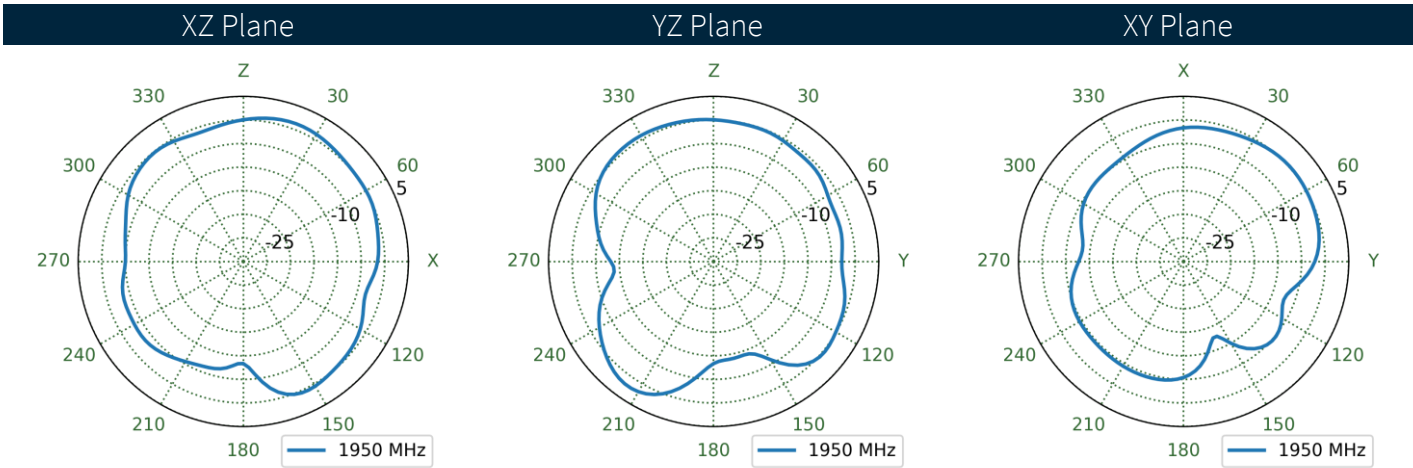
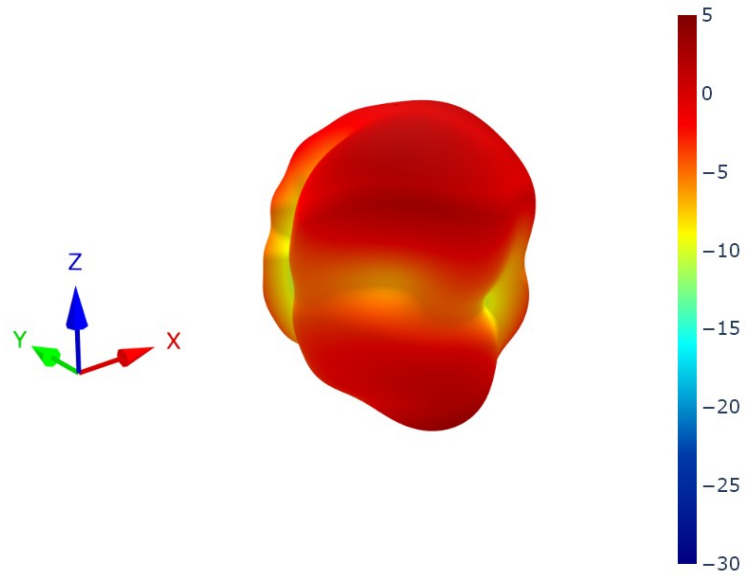

7.19 Antenna 2 Patterns at 1950 MHz

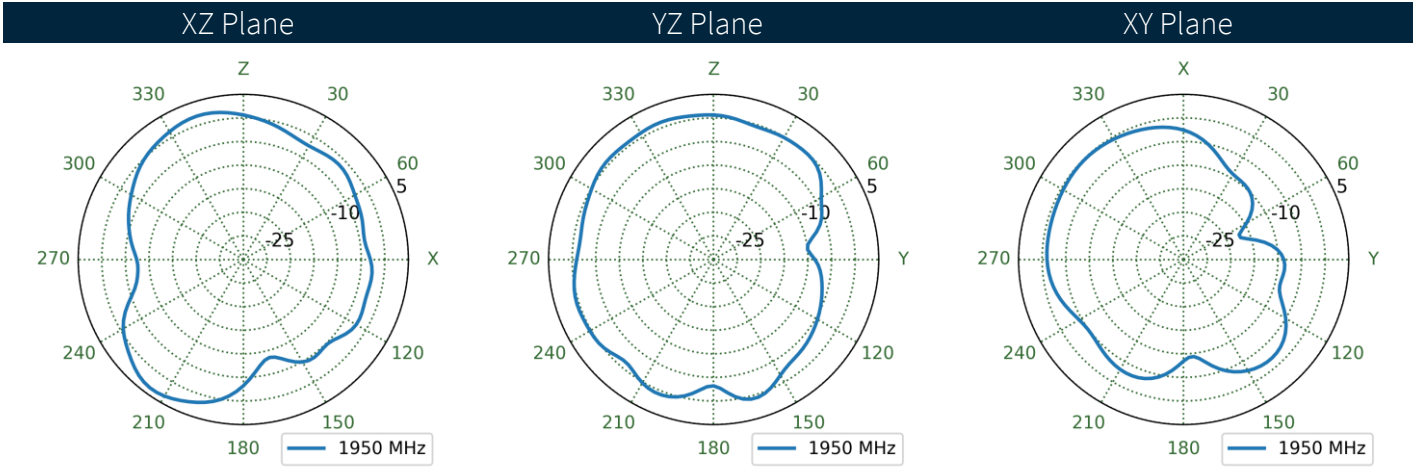
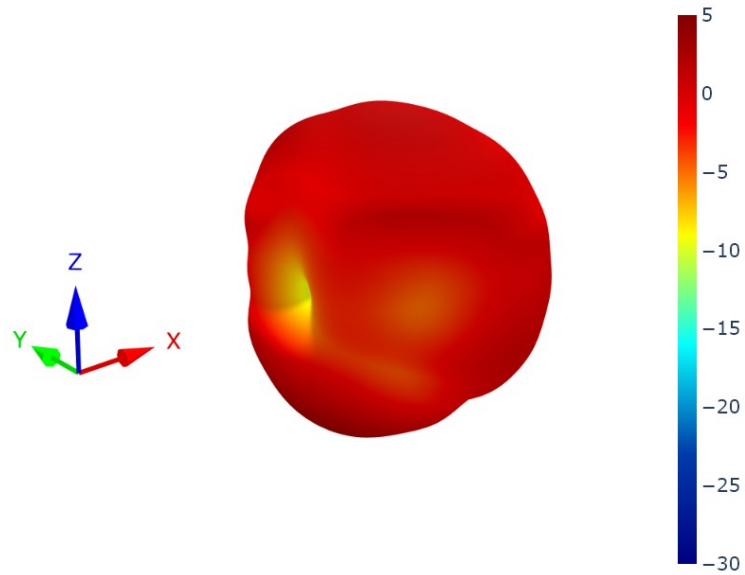

7.20 Antenna 3 Patterns at 1950 MHz

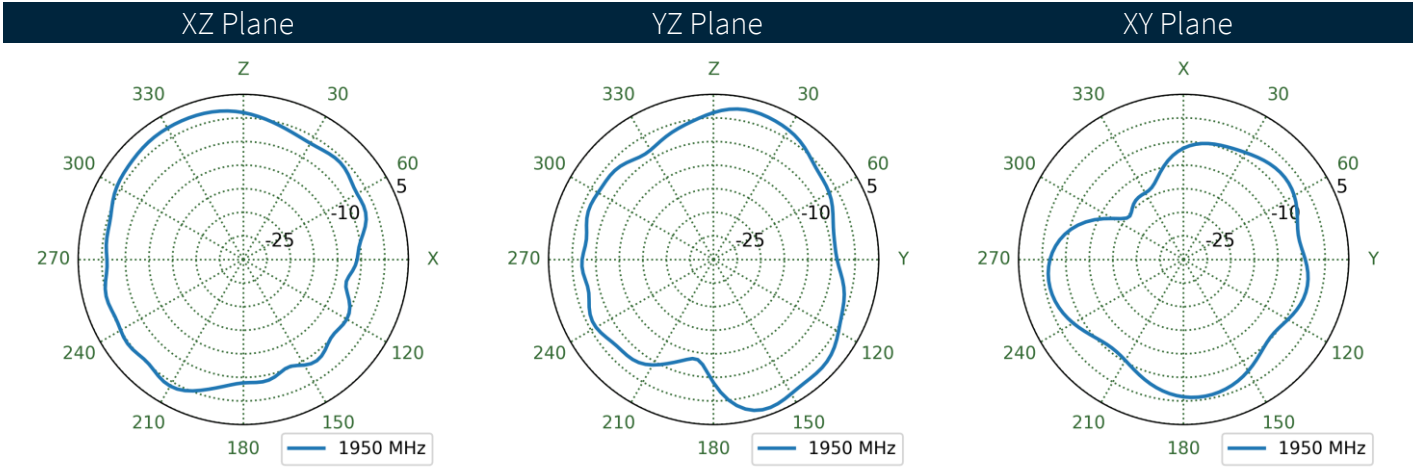
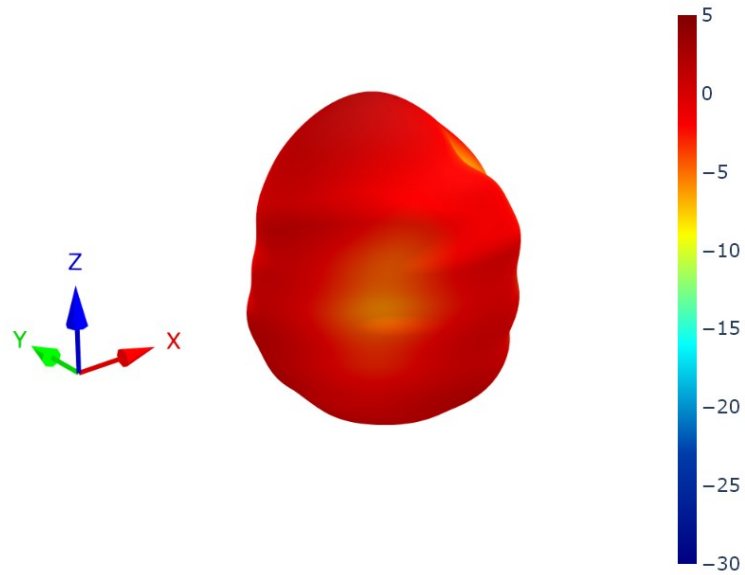

7.21 Antenna 4 Patterns at 1950 MHz

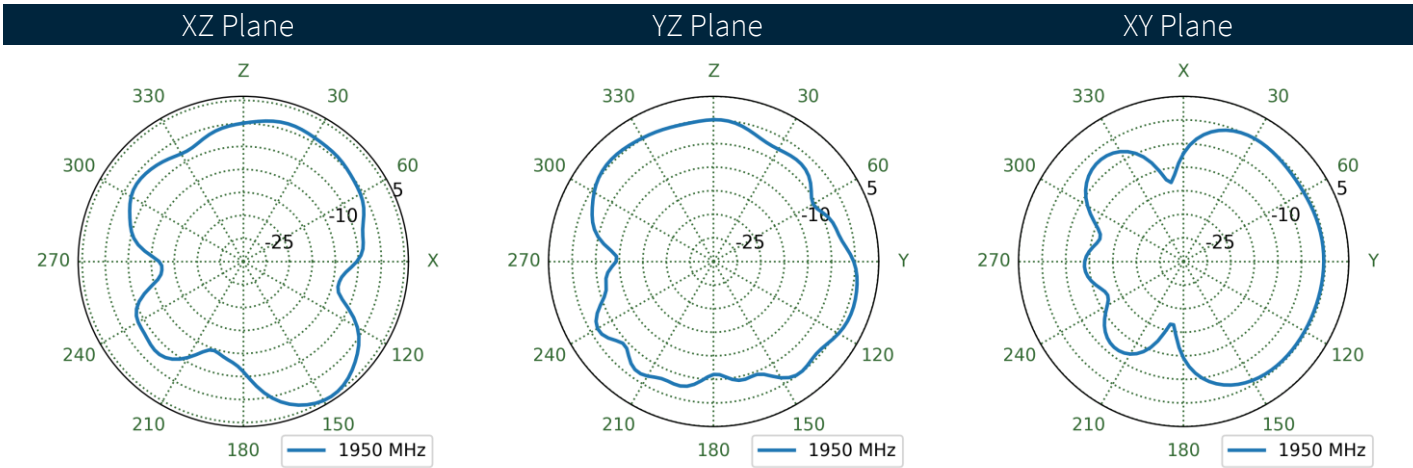
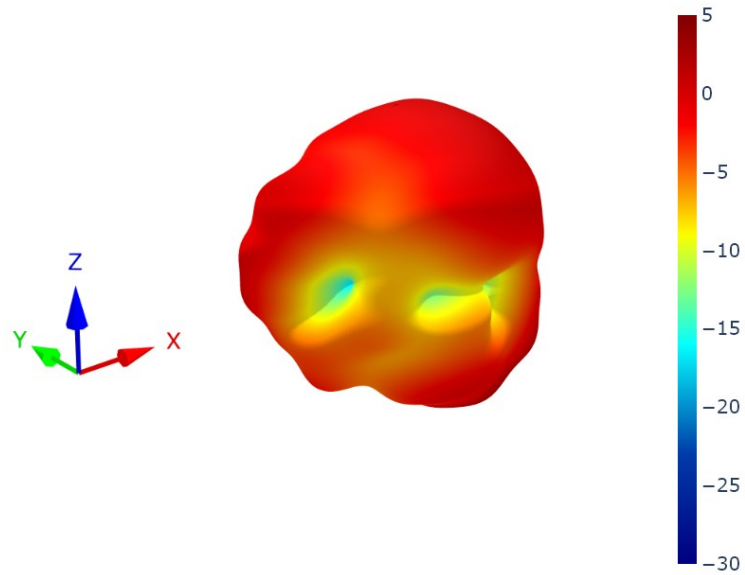

7.22 Antenna 1 Patterns at 2490 MHz

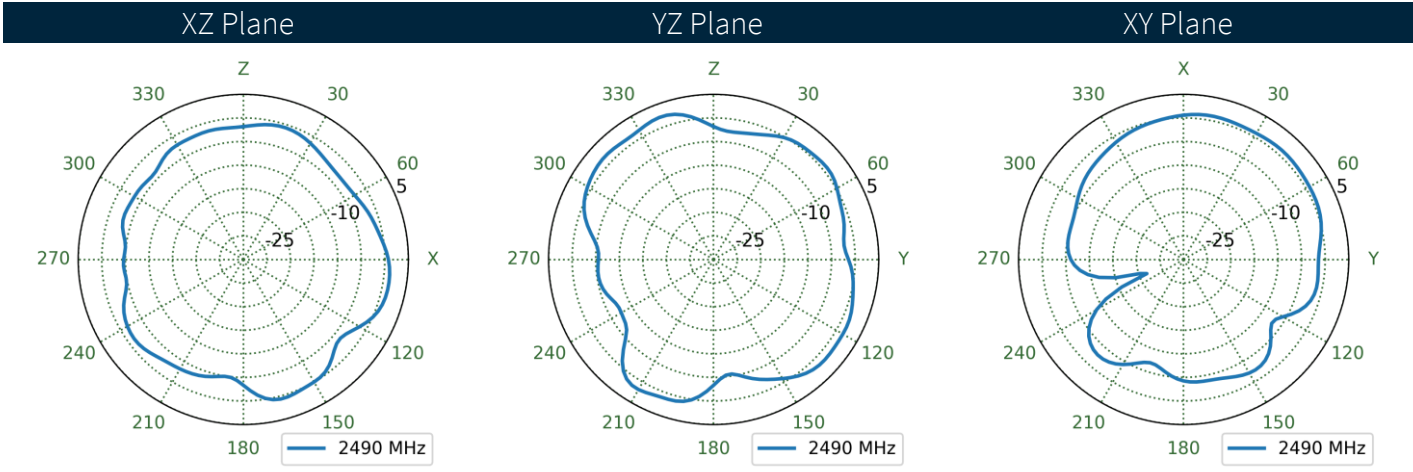
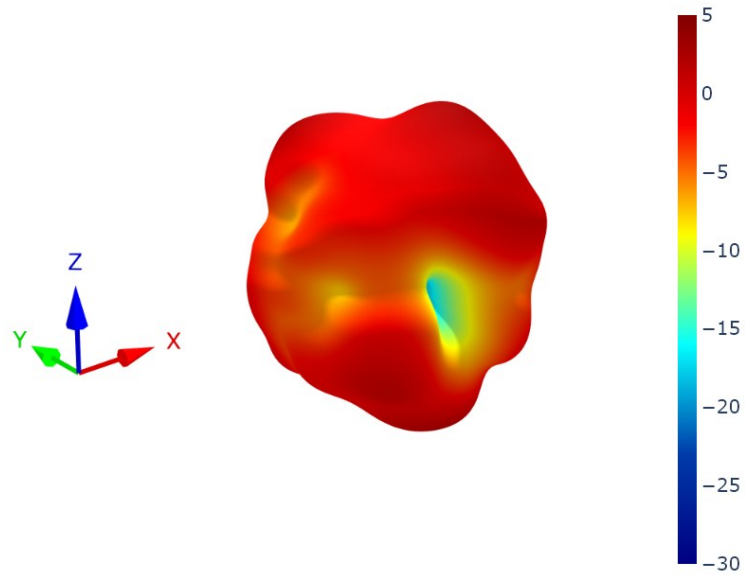

7.23 Antenna 2 Patterns at 2490 MHz

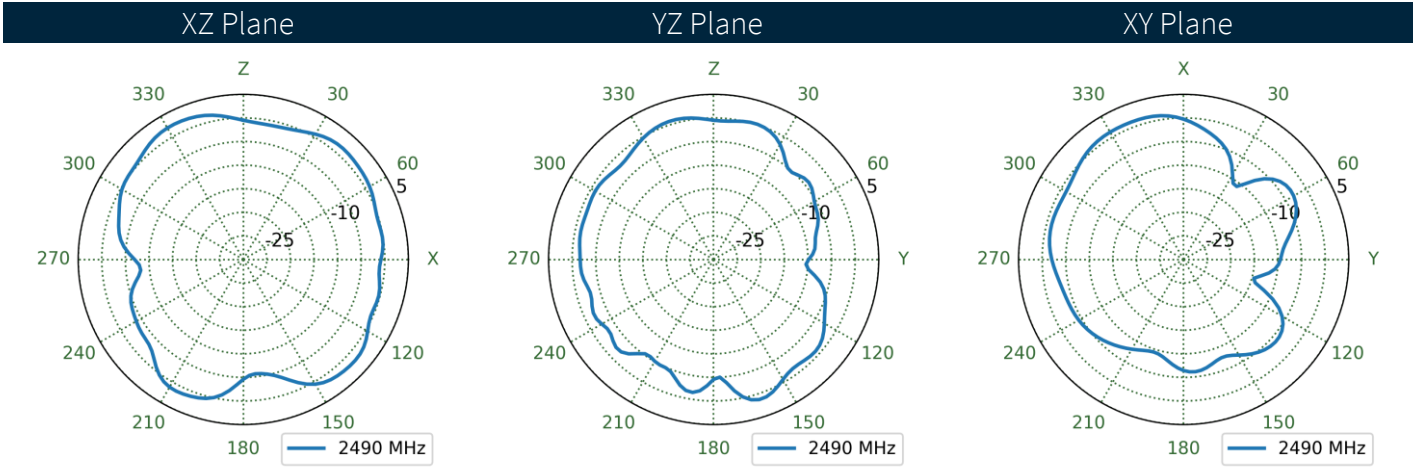
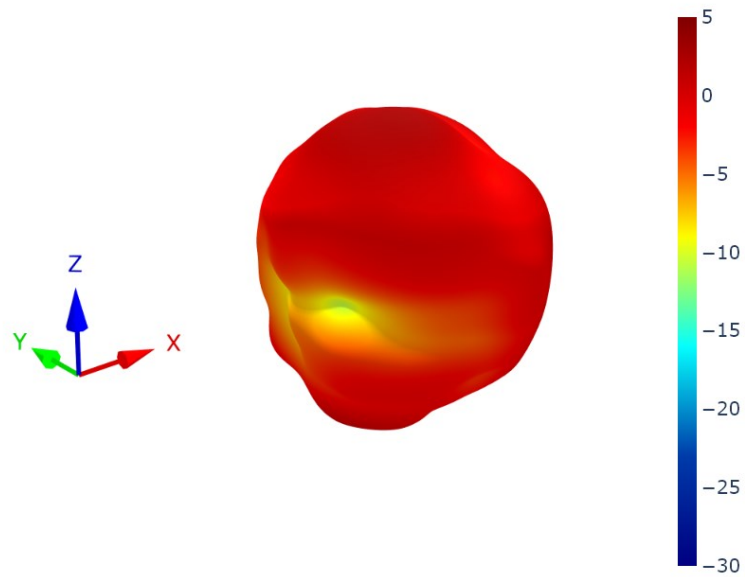

7.24 Antenna 3 Patterns at 2490 MHz

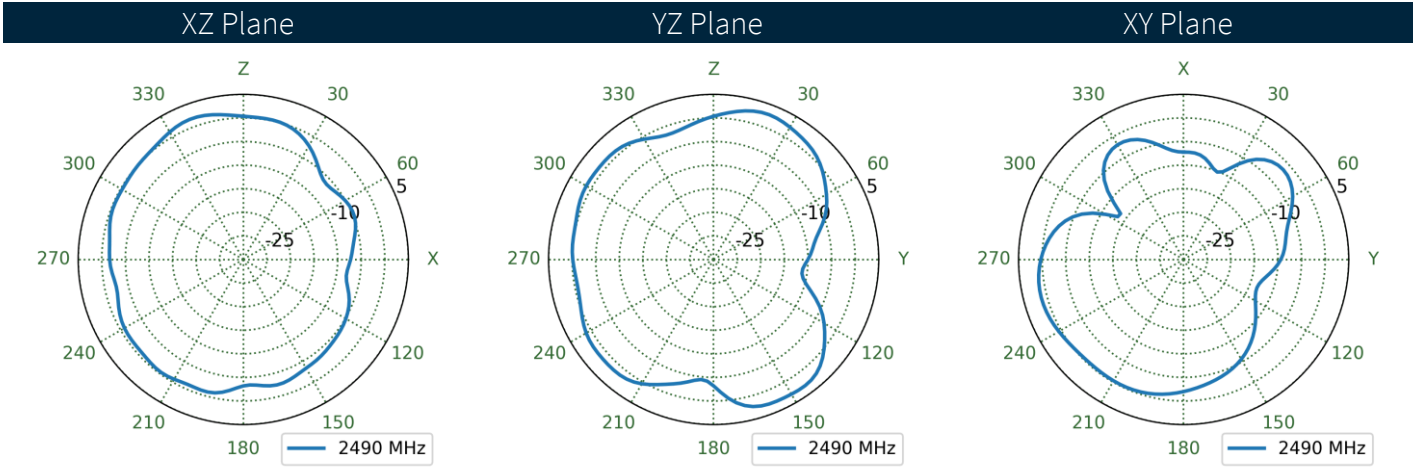
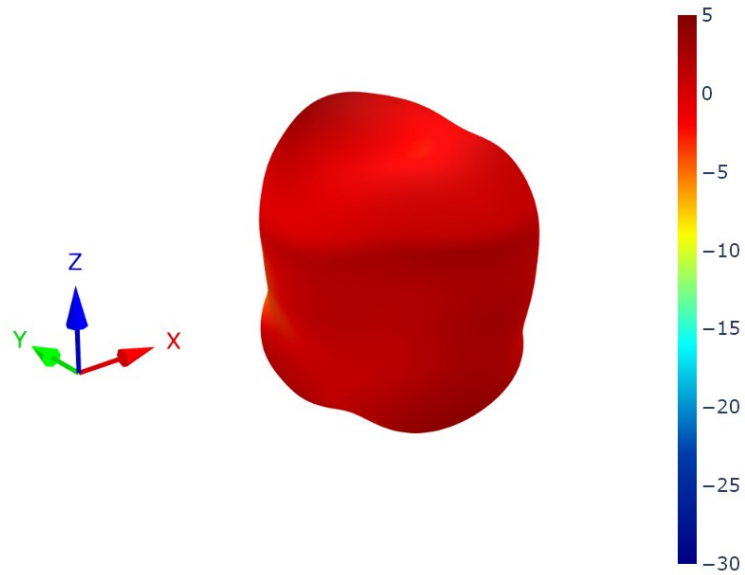

7.25 Antenna 4 Patterns at 2490 MHz

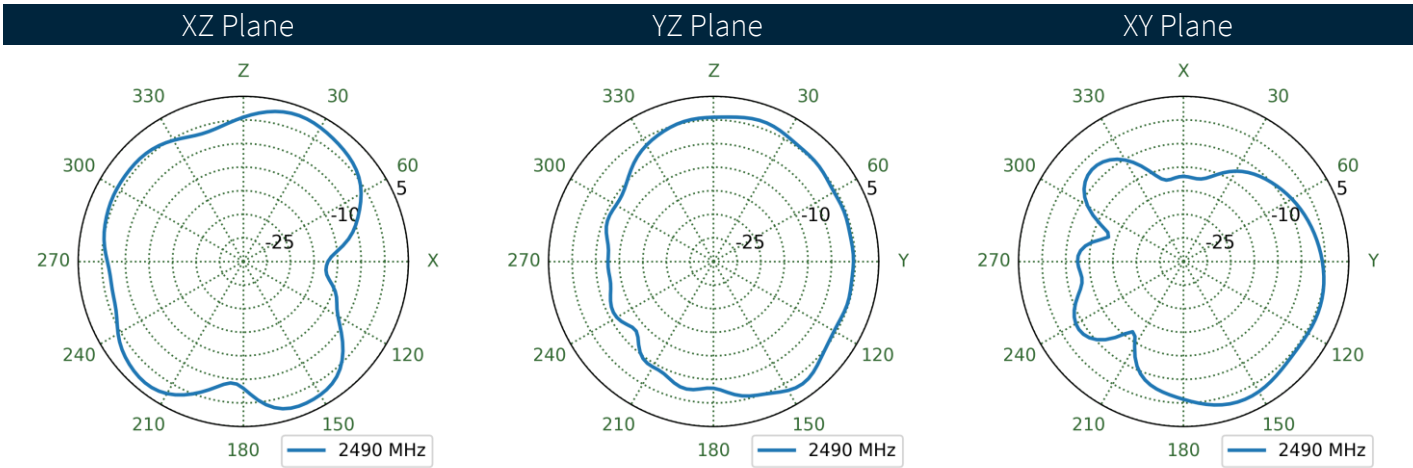
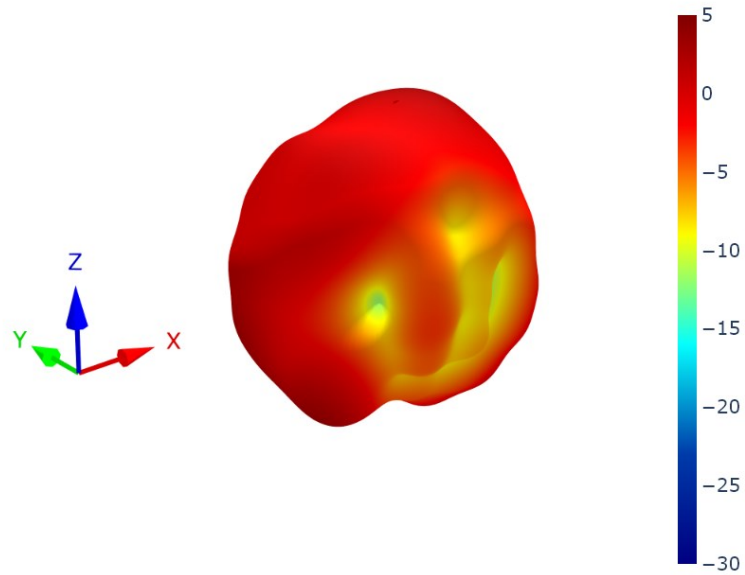

7.26 Antenna 1 Patterns at 4150 MHz

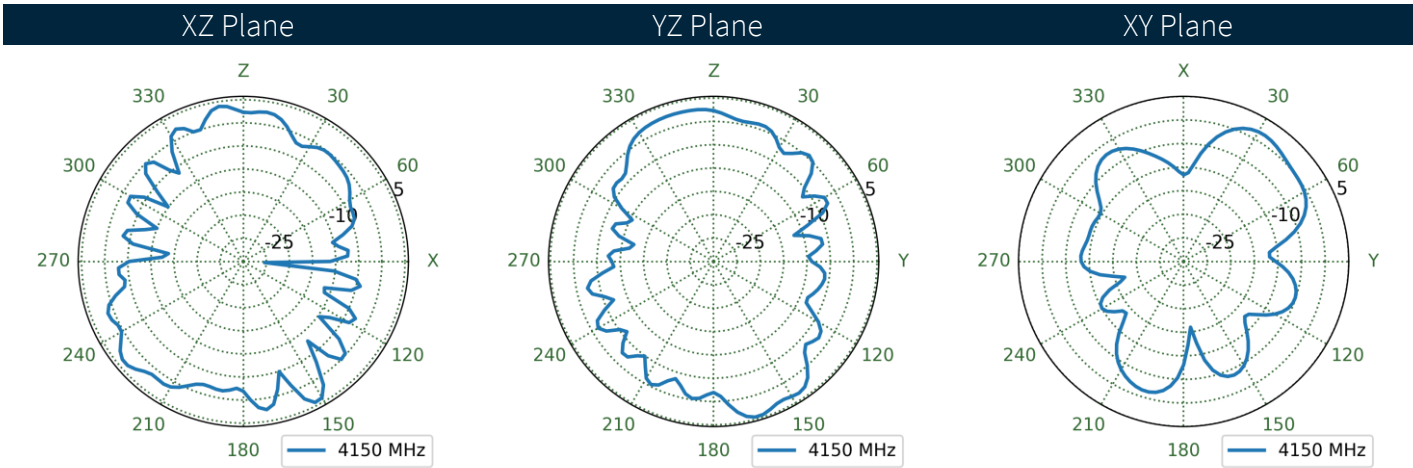
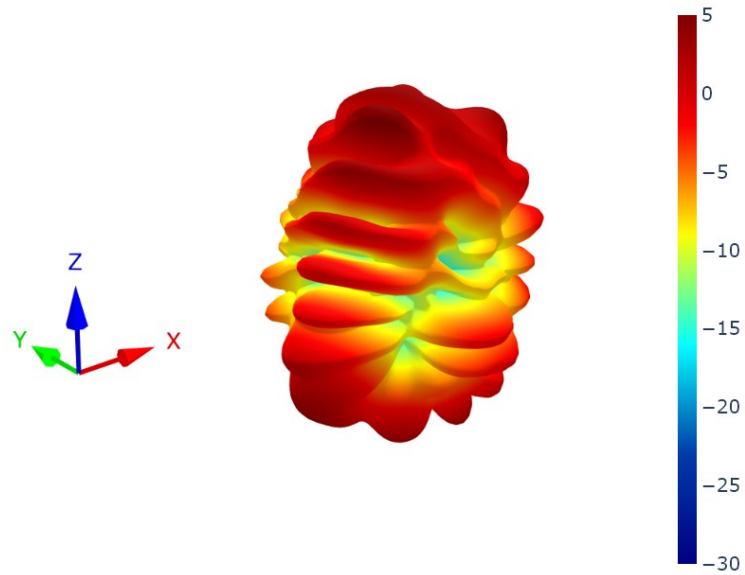

7.27 Antenna 2 Patterns at 4150 MHz

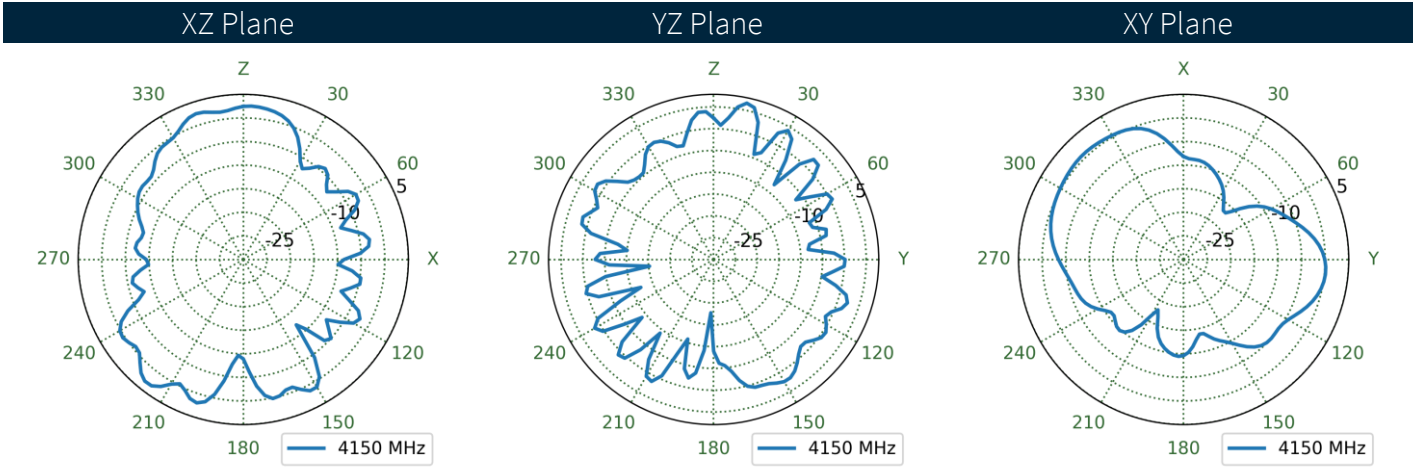
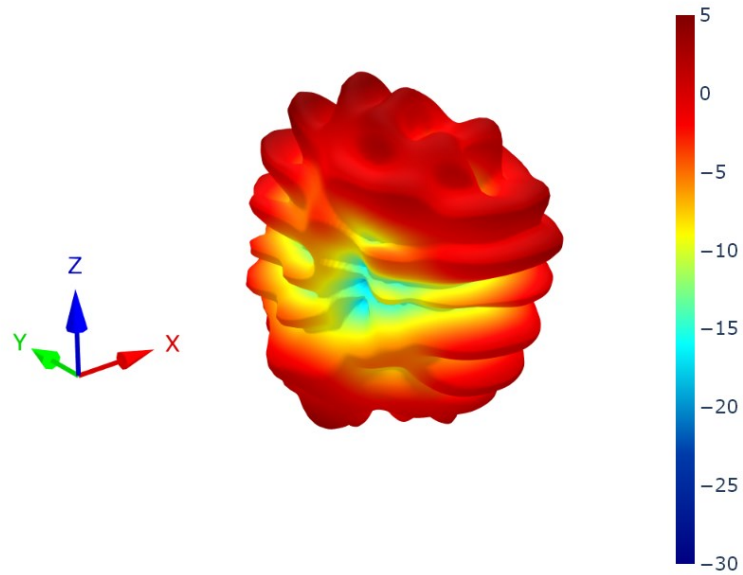

7.28 Antenna 3 Patterns at 4150 MHz

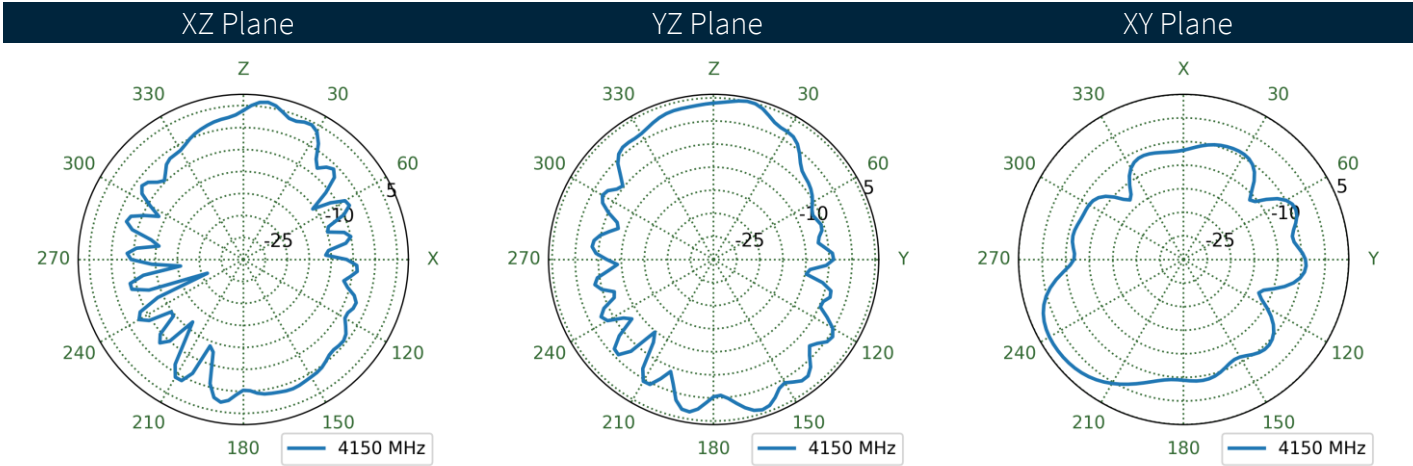
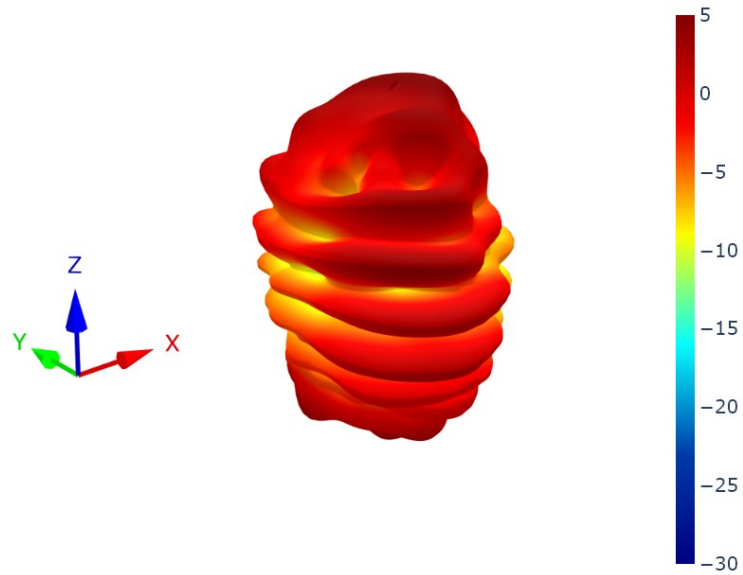

7.29 Antenna 4 Patterns at 4150 MHz

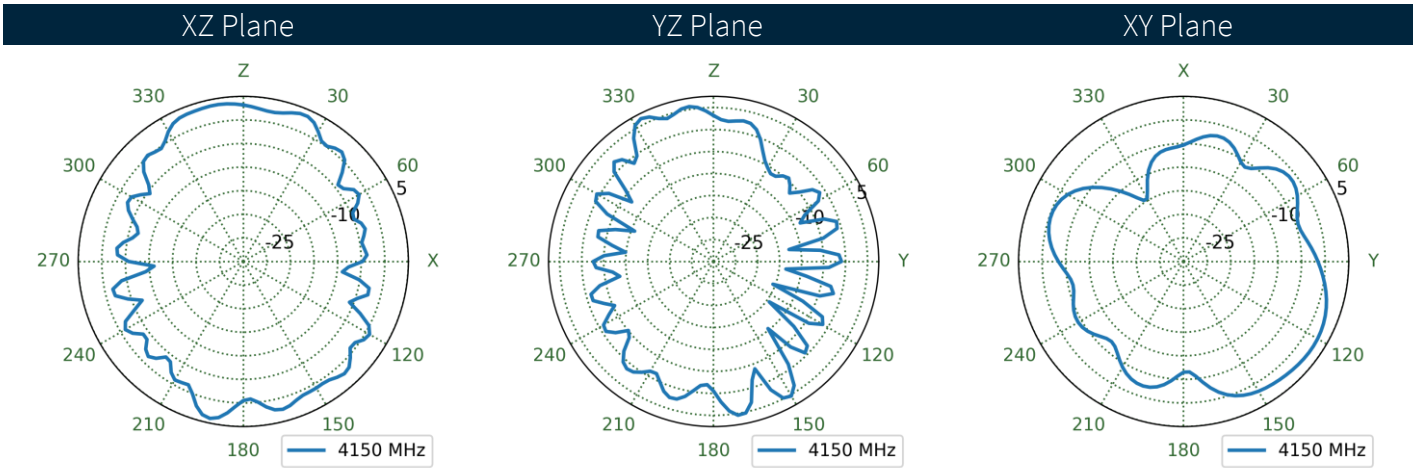
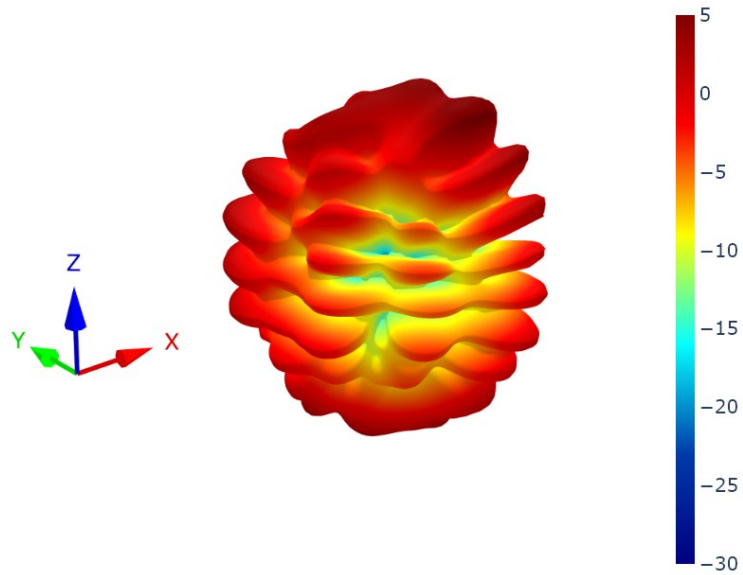

7.30 Antenna 1 Patterns at 5540 MHz

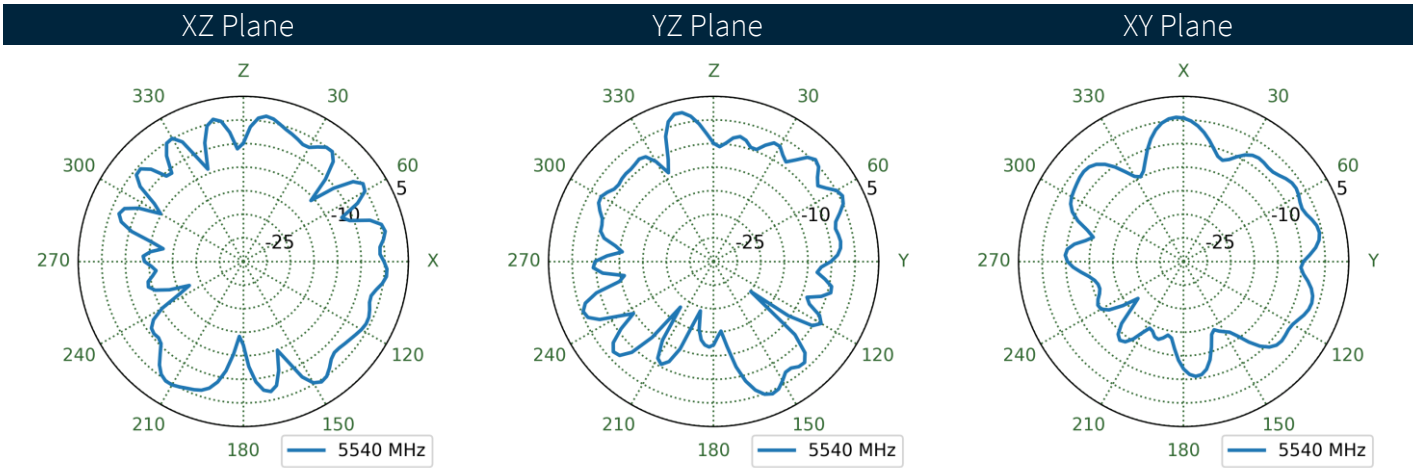
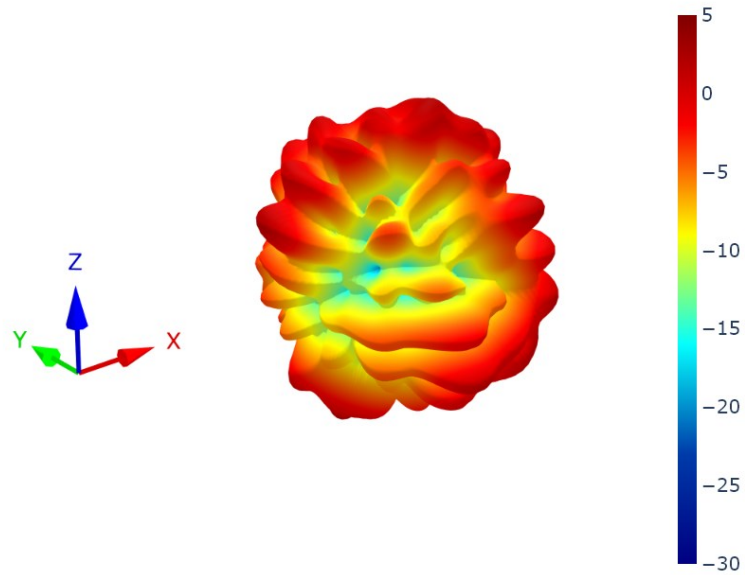

7.31 Antenna 2 Patterns at 5540 MHz

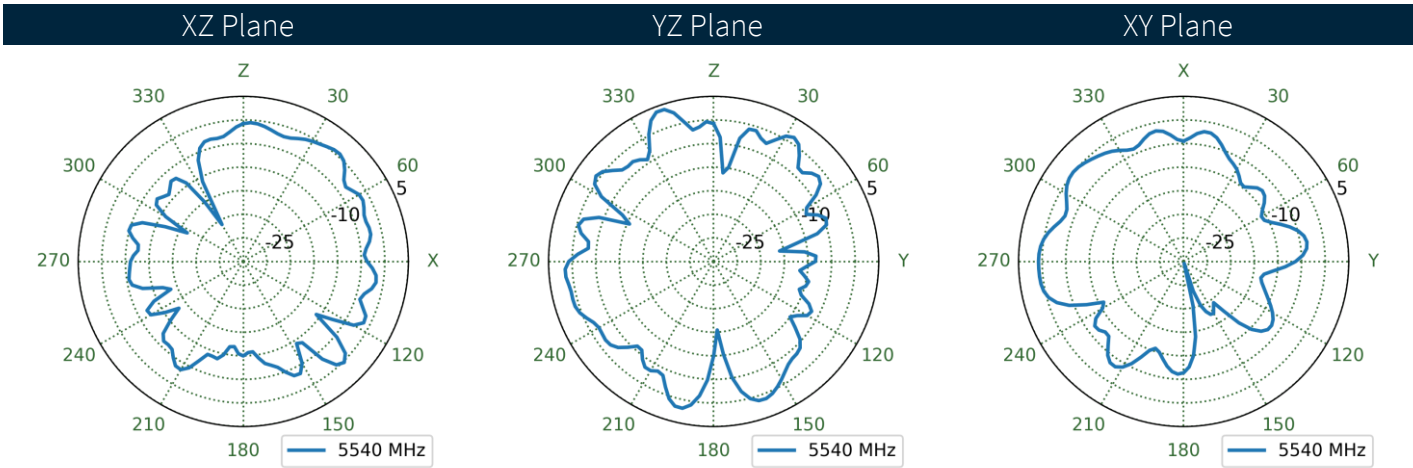
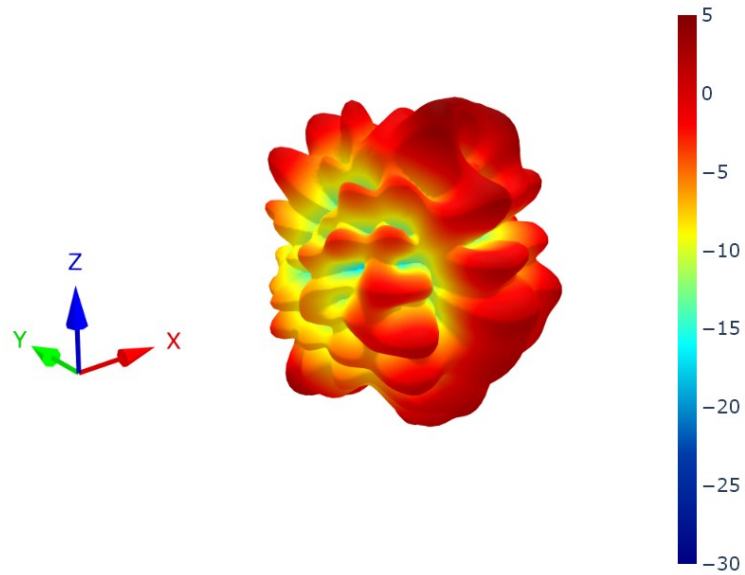

7.32 Antenna 3 Patterns at 5540 MHz

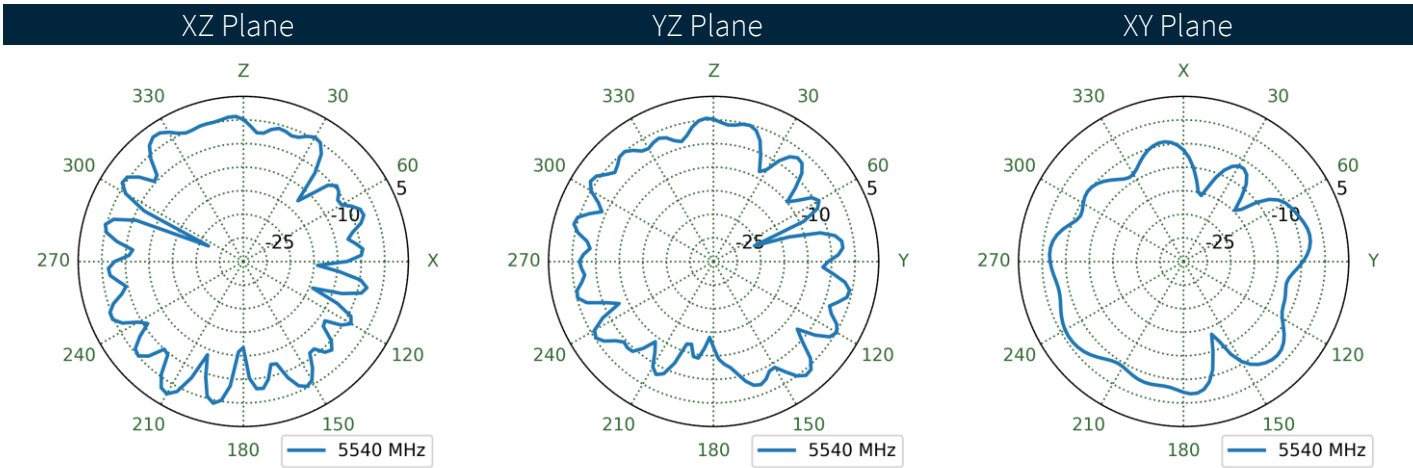
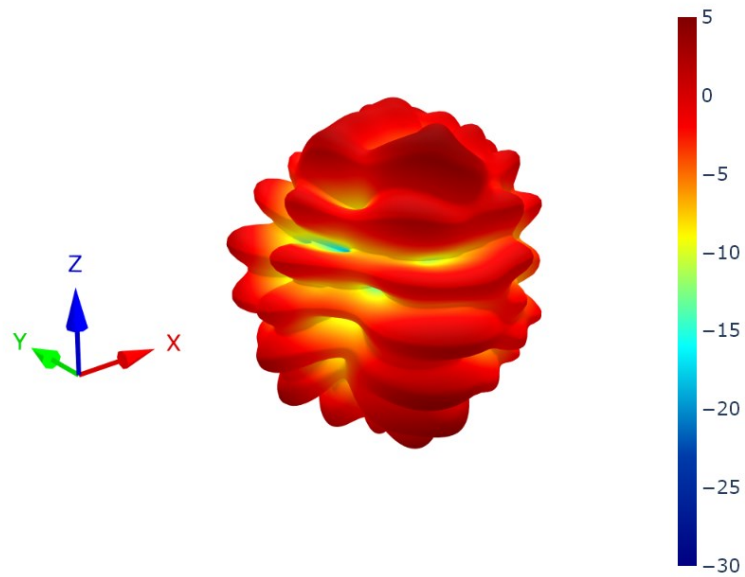

7.33 Antenna 4 Patterns at 5540 MHz

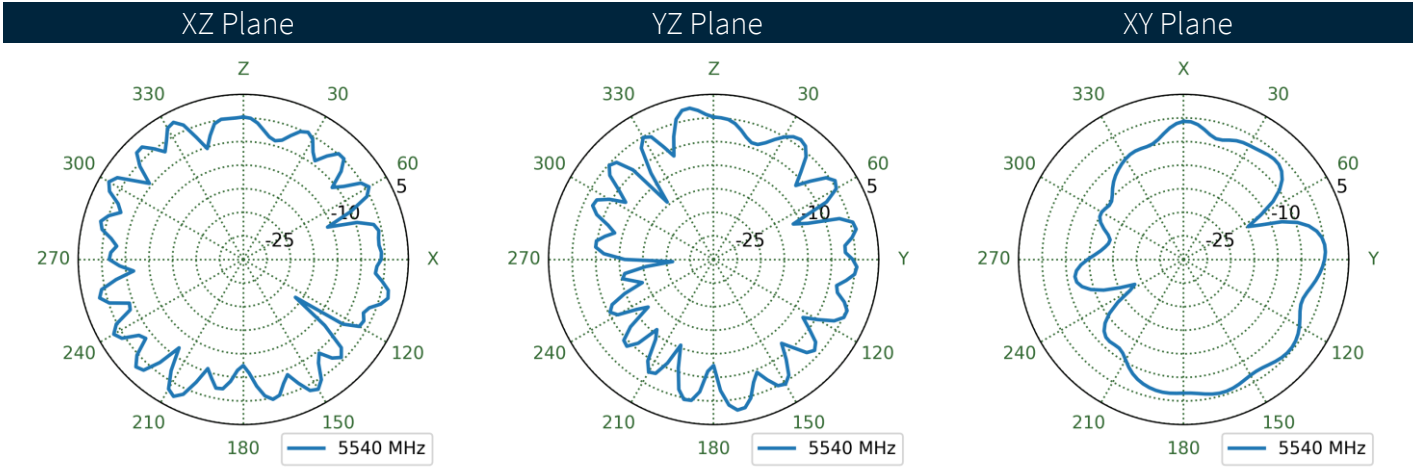
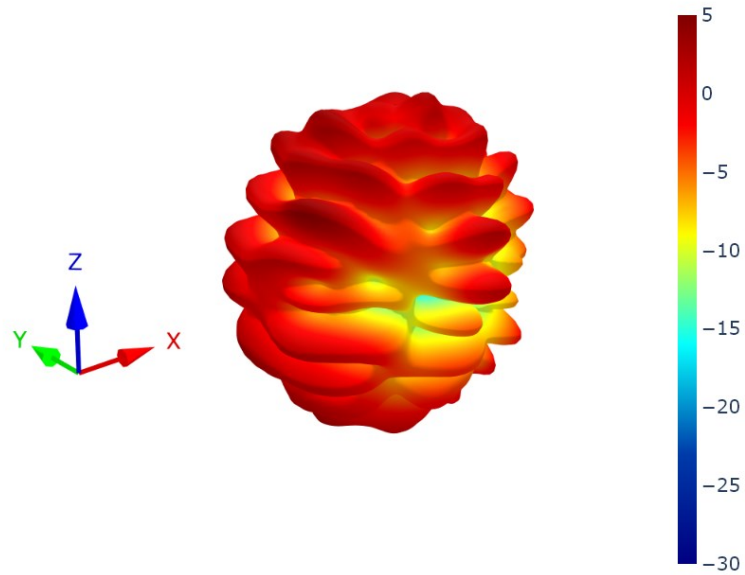

7.34 Antenna 1 Patterns at 6520 MHz

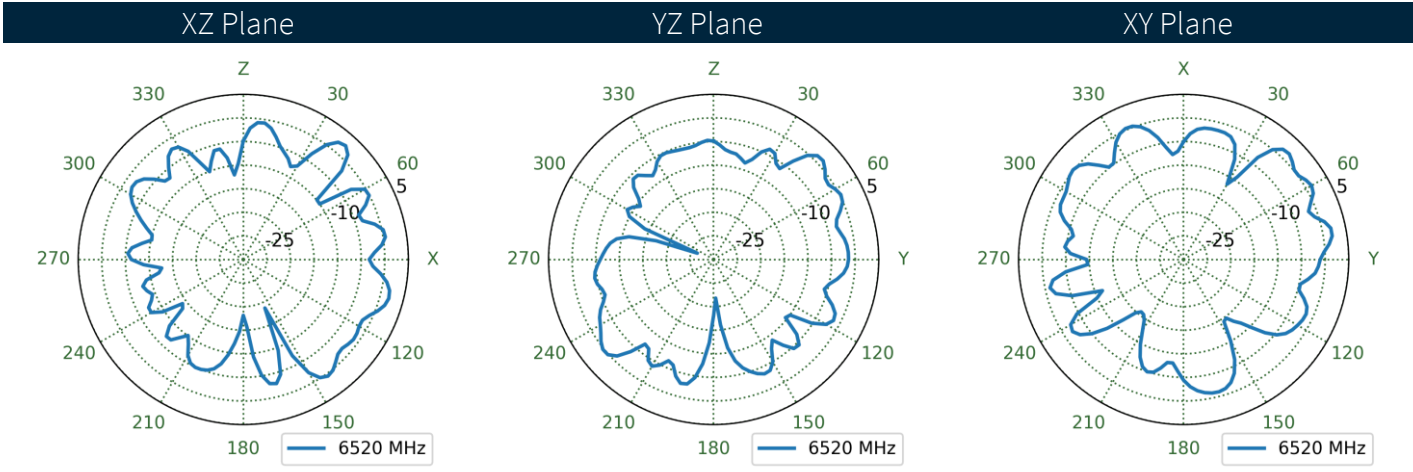
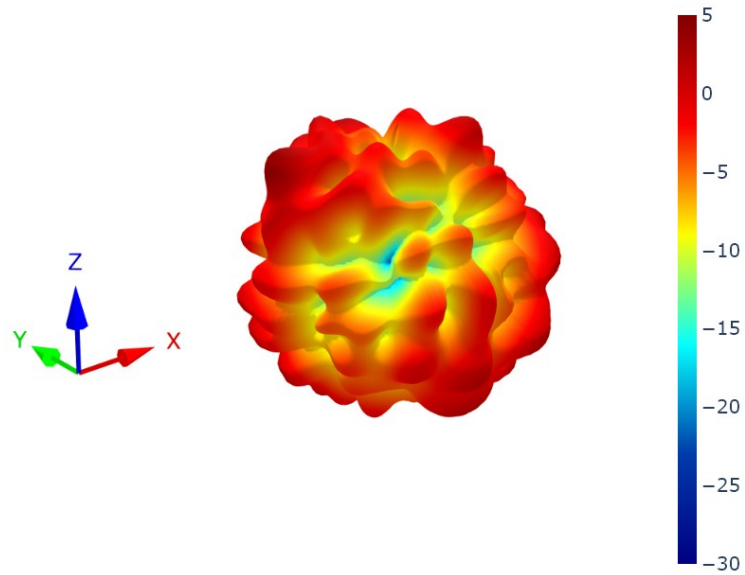

7.35 Antenna 2 Patterns at 6520 MHz

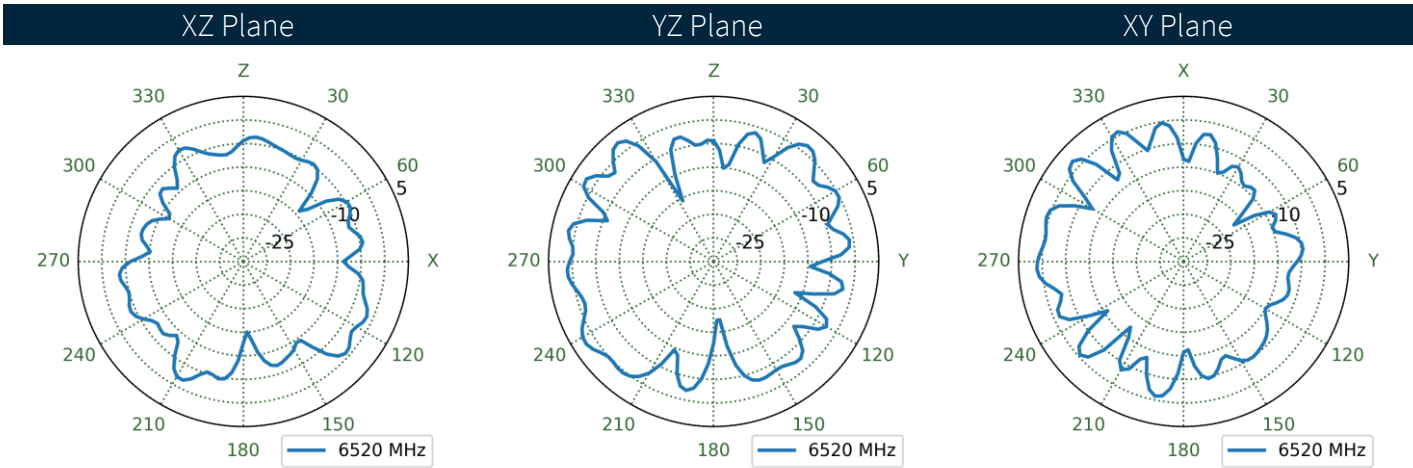
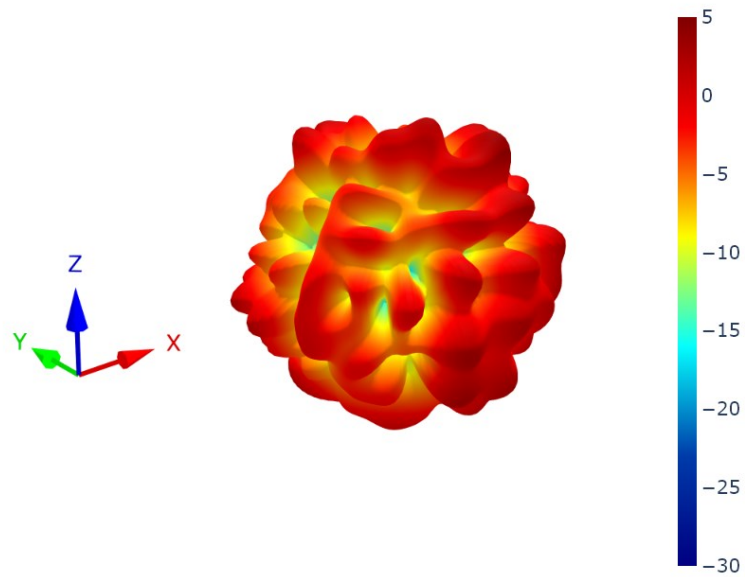

7.36 Antenna 3 Patterns at 6520 MHz

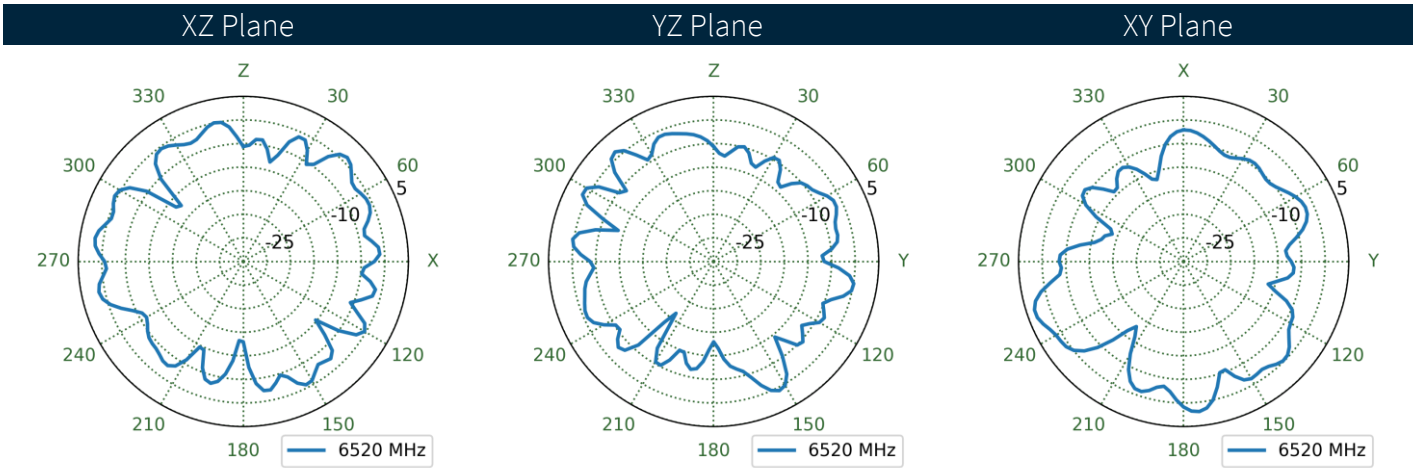
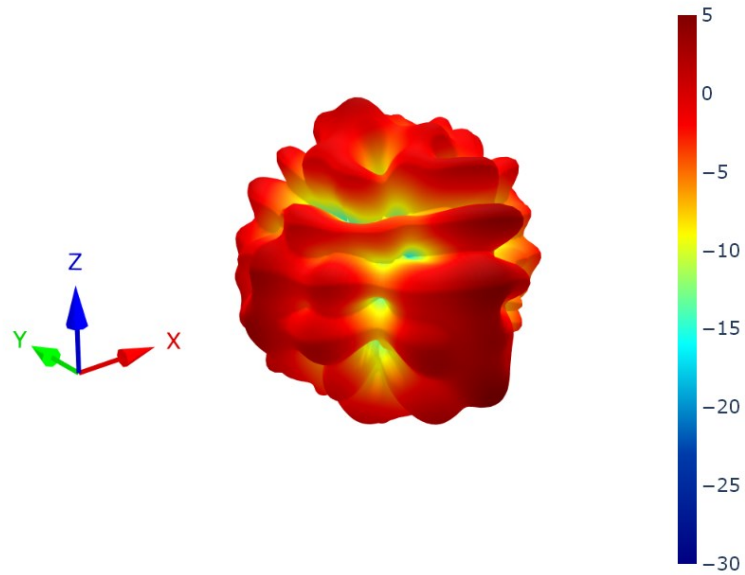

7.37 Antenna 4 Patterns at 6520 MHz

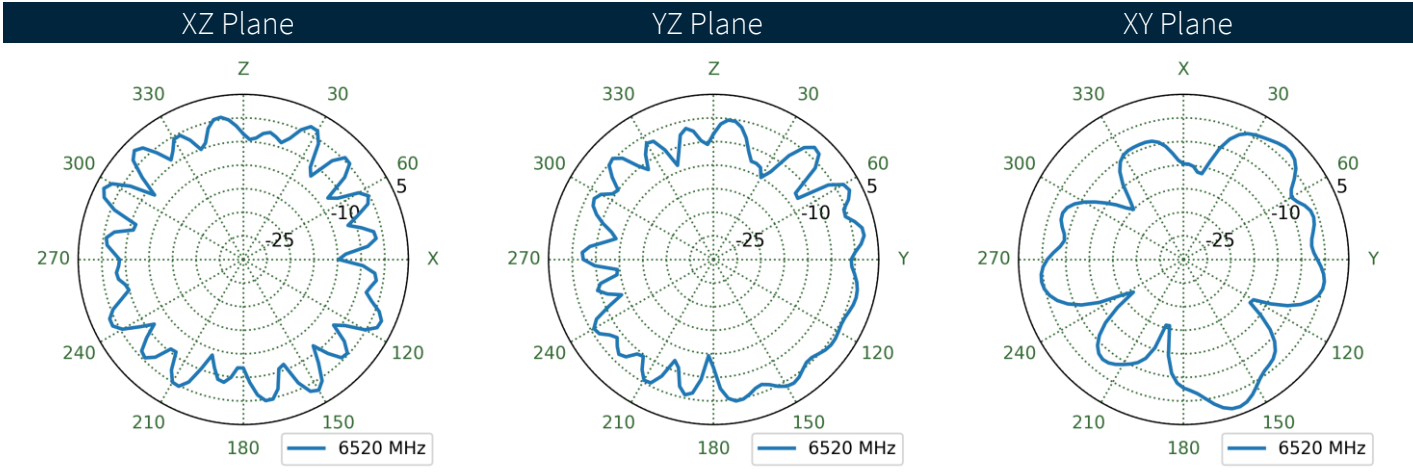
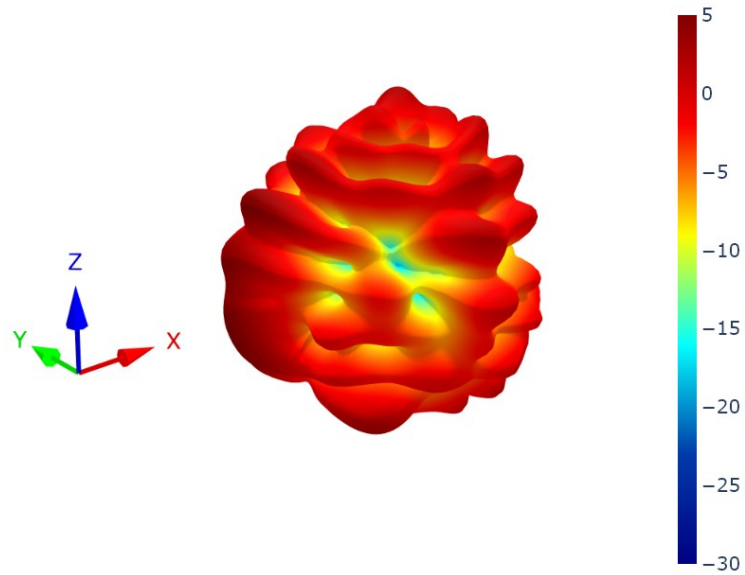

8. Radiation Patterns (Outer)

8.1 Test Setup

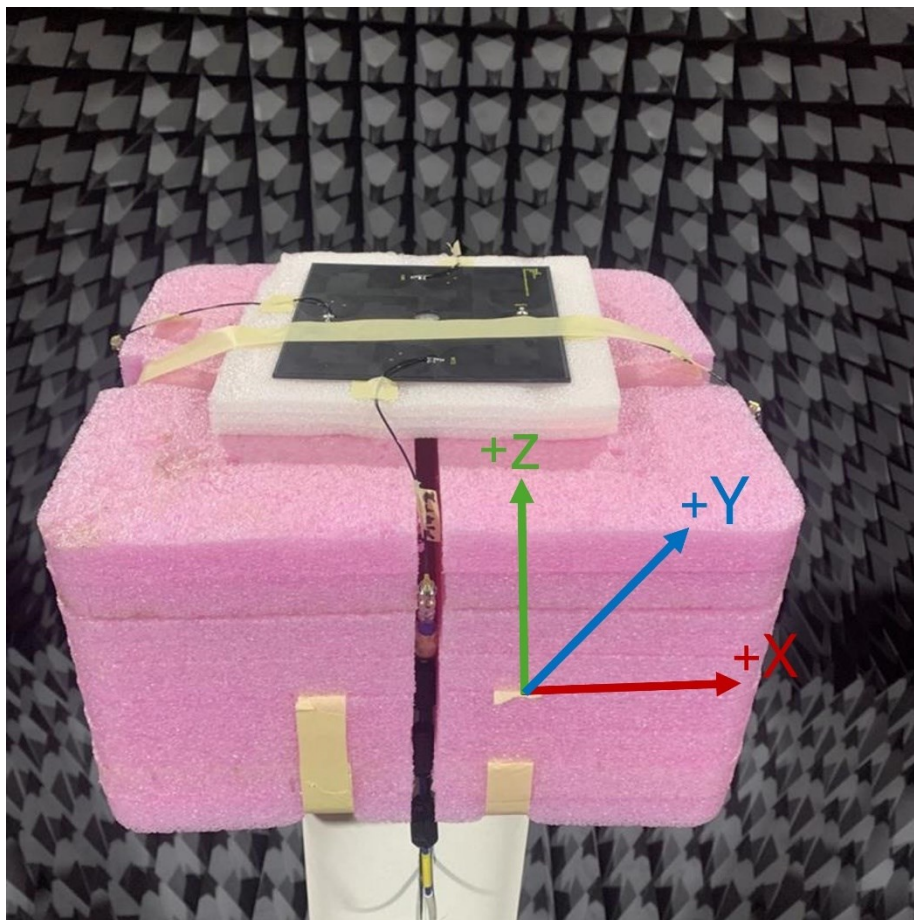
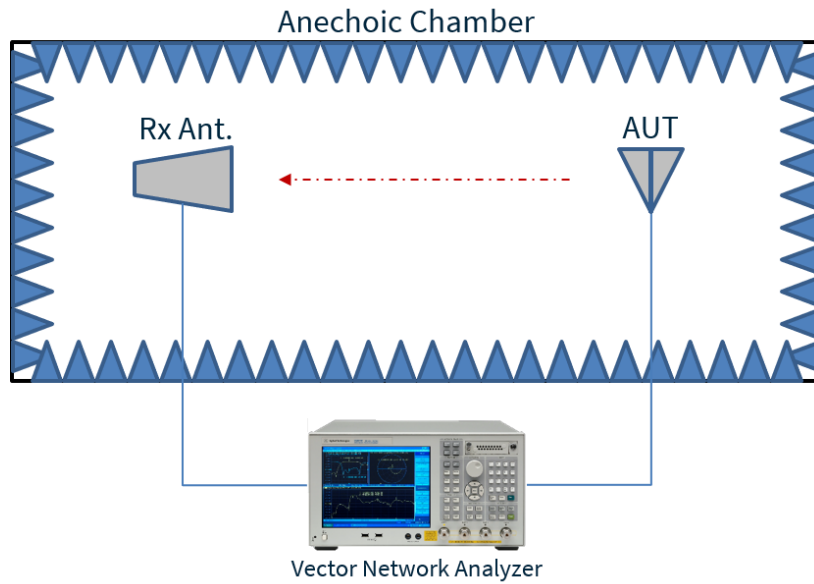

Chamber Set-up with cables going outward away from the Antenna

8.2 Antenna 1 Patterns at 660 MHz

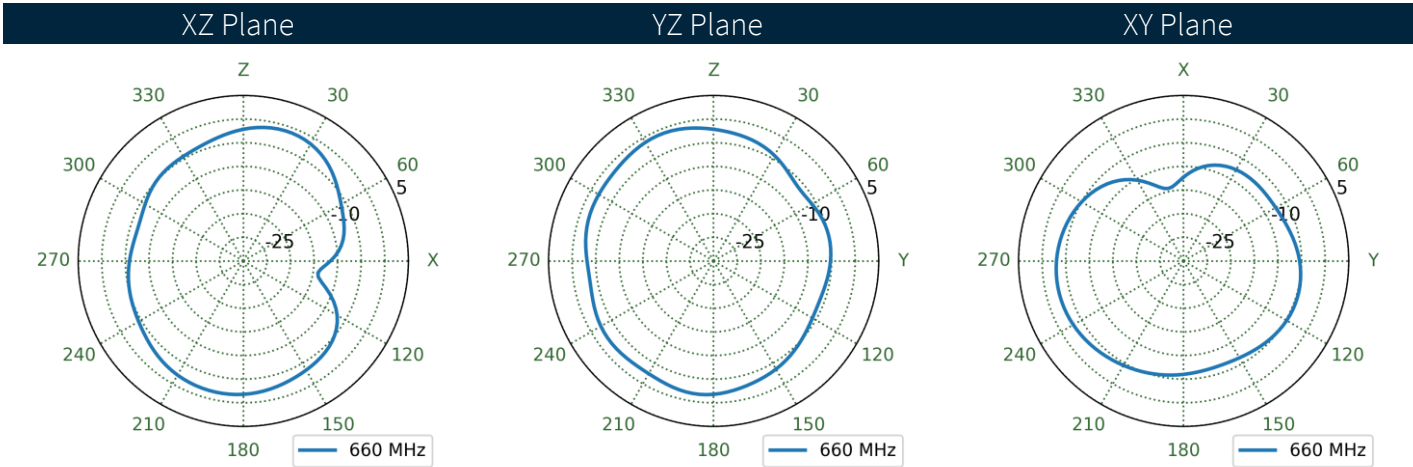
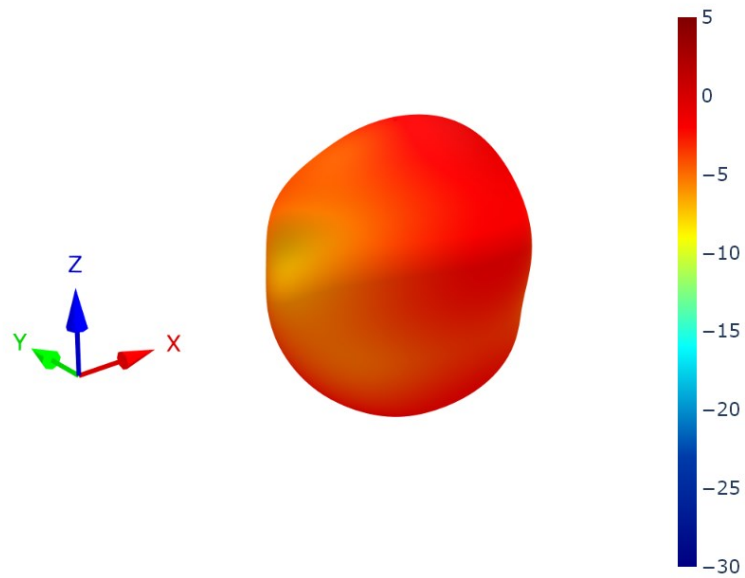

8.3 Antenna 2 Patterns at 660 MHz

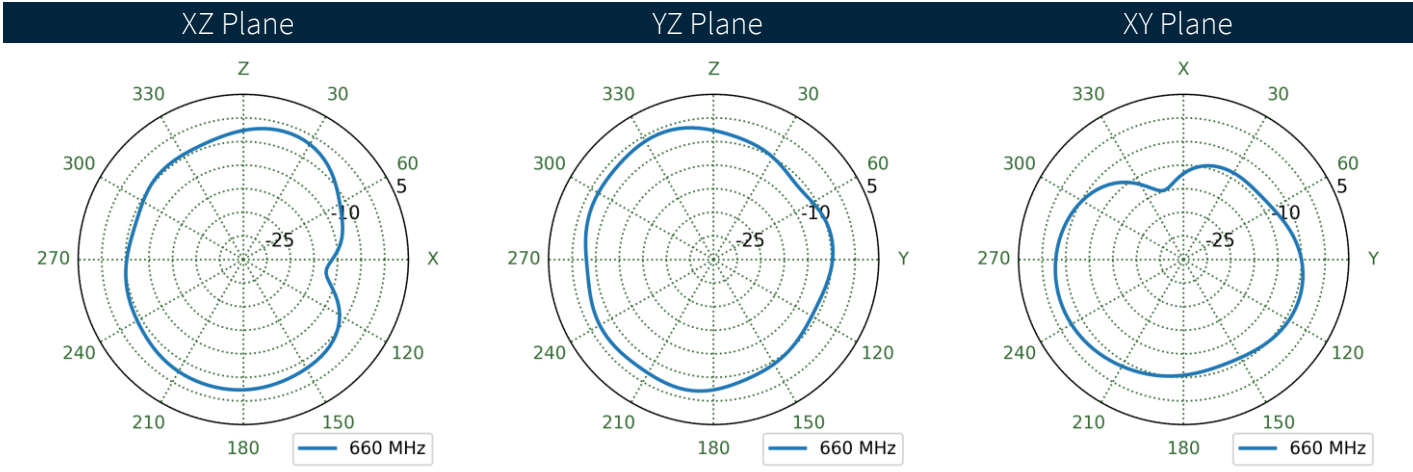
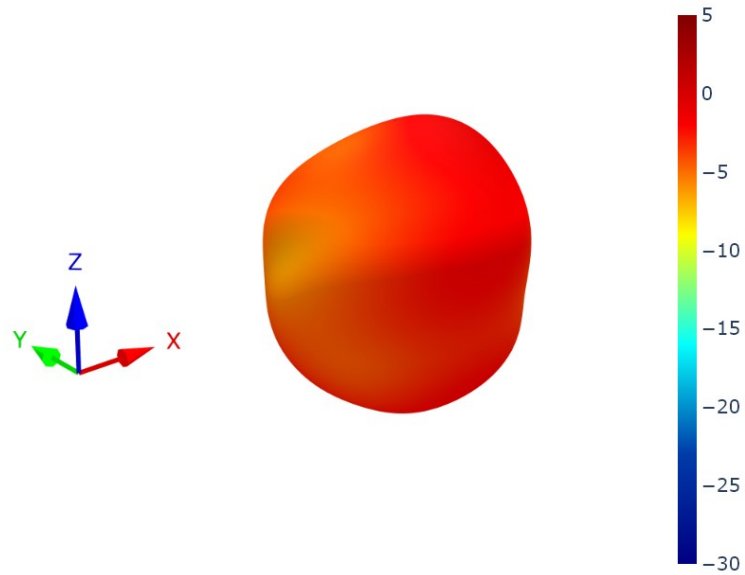

8.4 Antenna 3 Patterns at 660 MHz

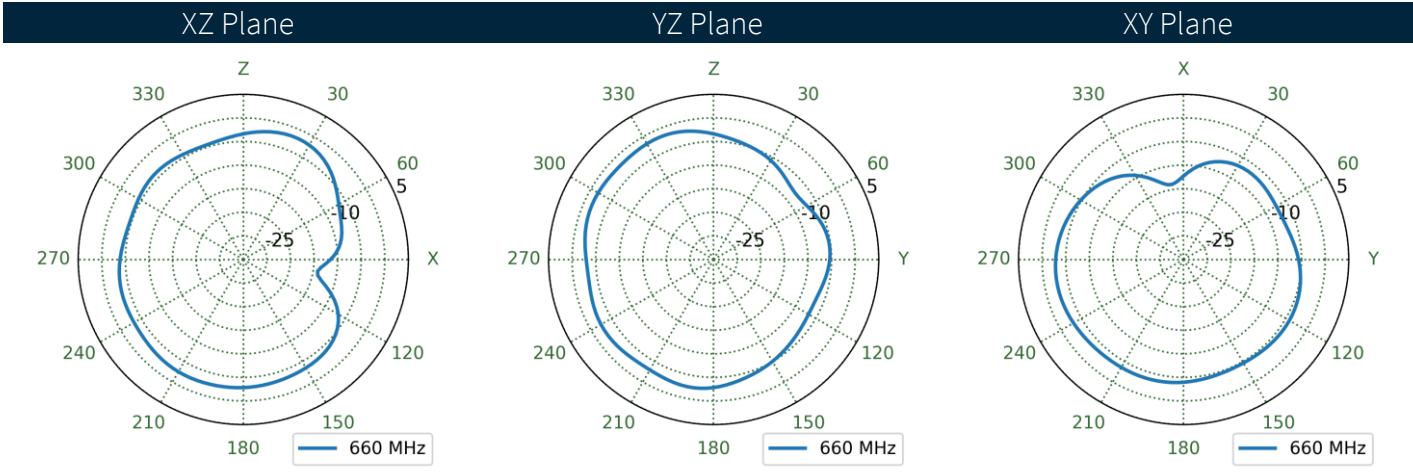
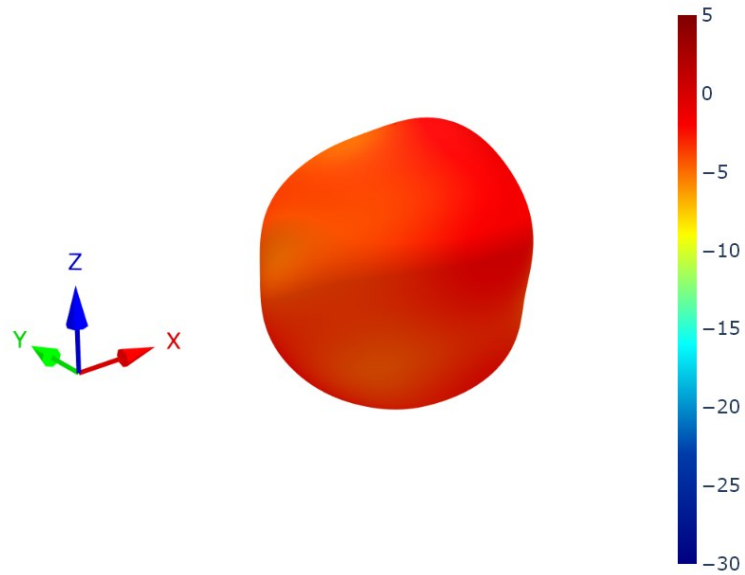

8.5 Antenna 4 Patterns at 660 MHz

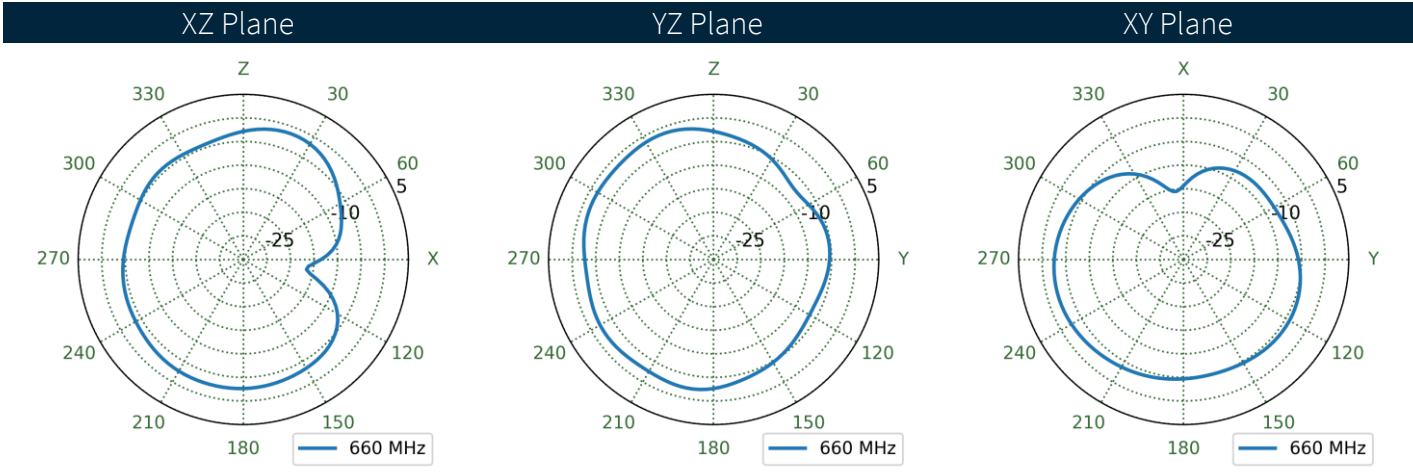
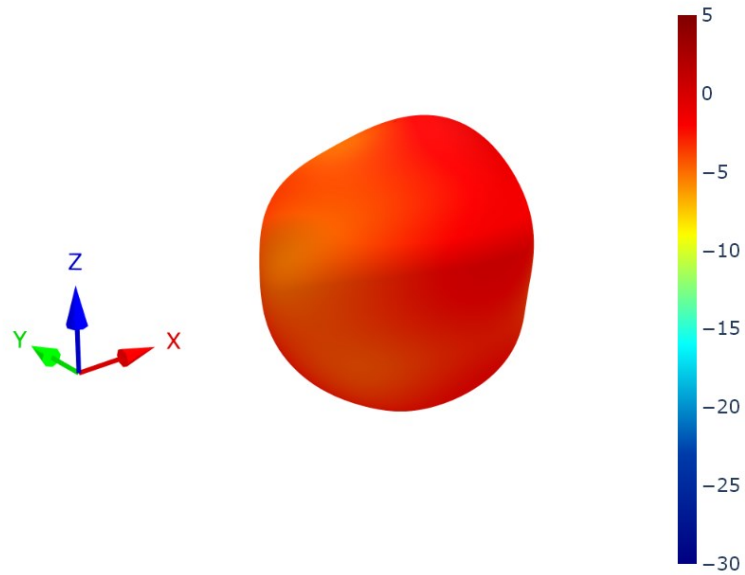

8.6 Antenna 1 Patterns at 750 MHz

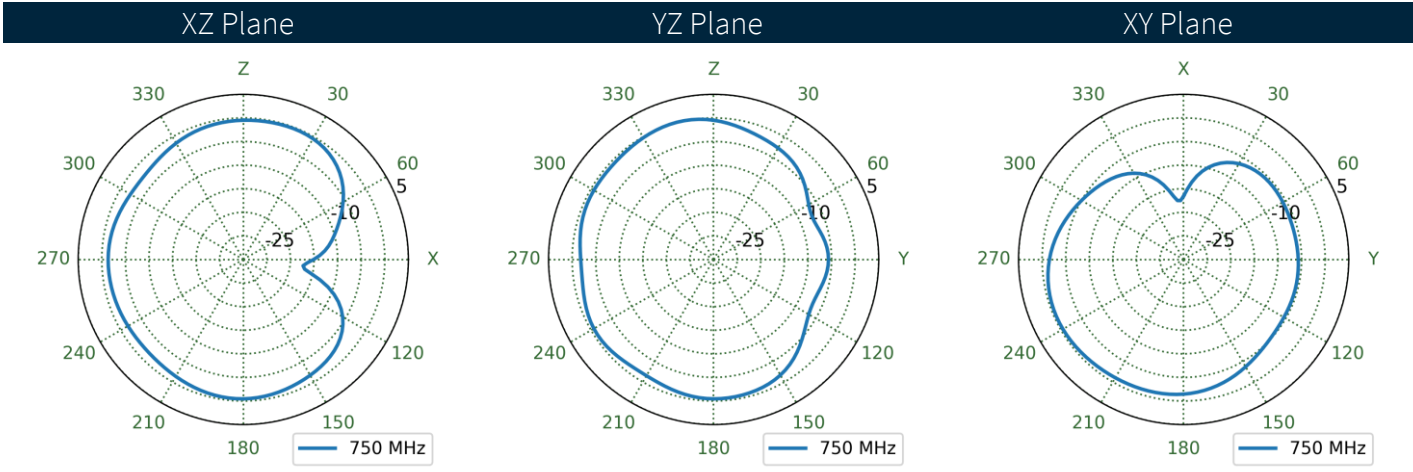
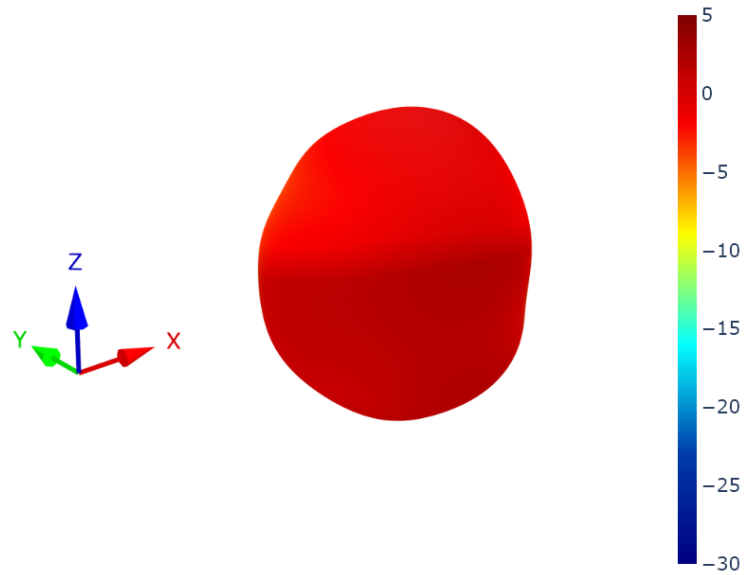

8.7 Antenna 2 Patterns at 750 MHz

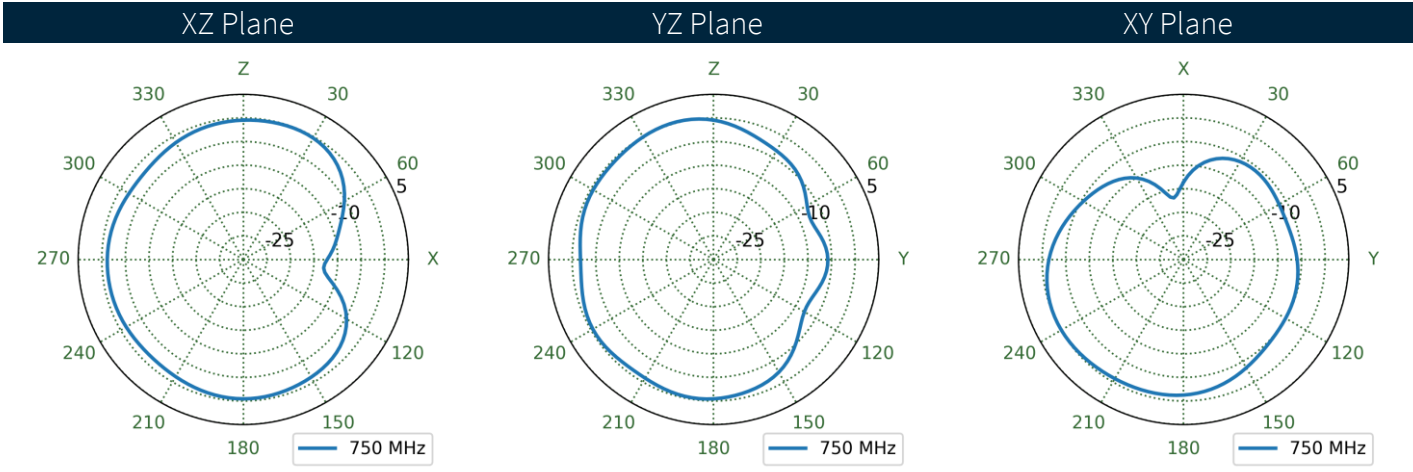
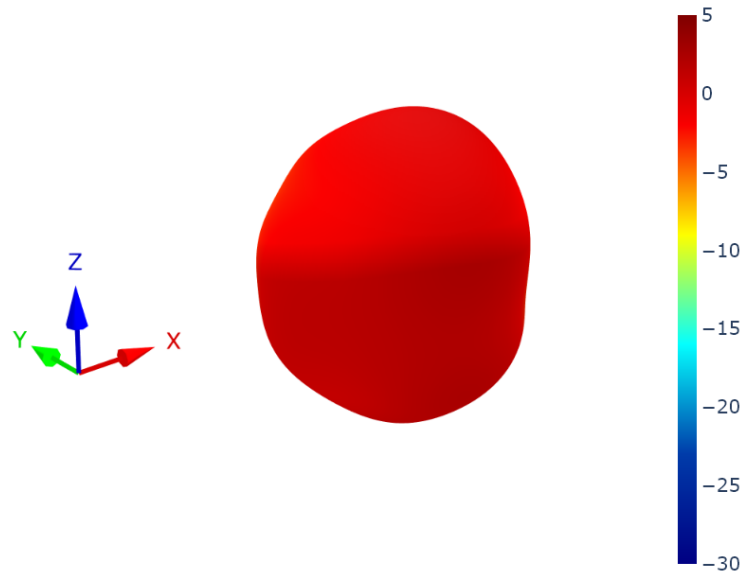

8.8 Antenna 3 Patterns at 750 MHz

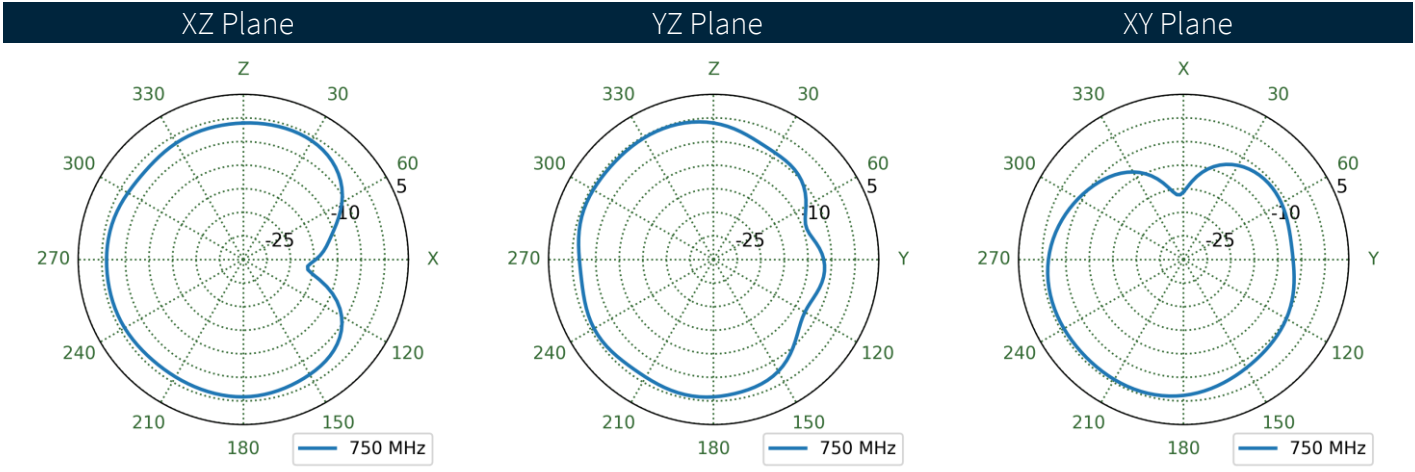
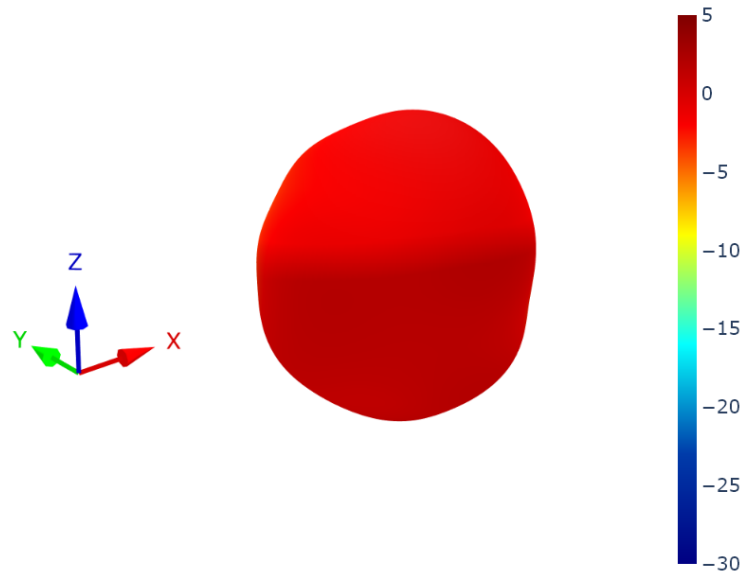

8.9 Antenna 4 Patterns at 750 MHz

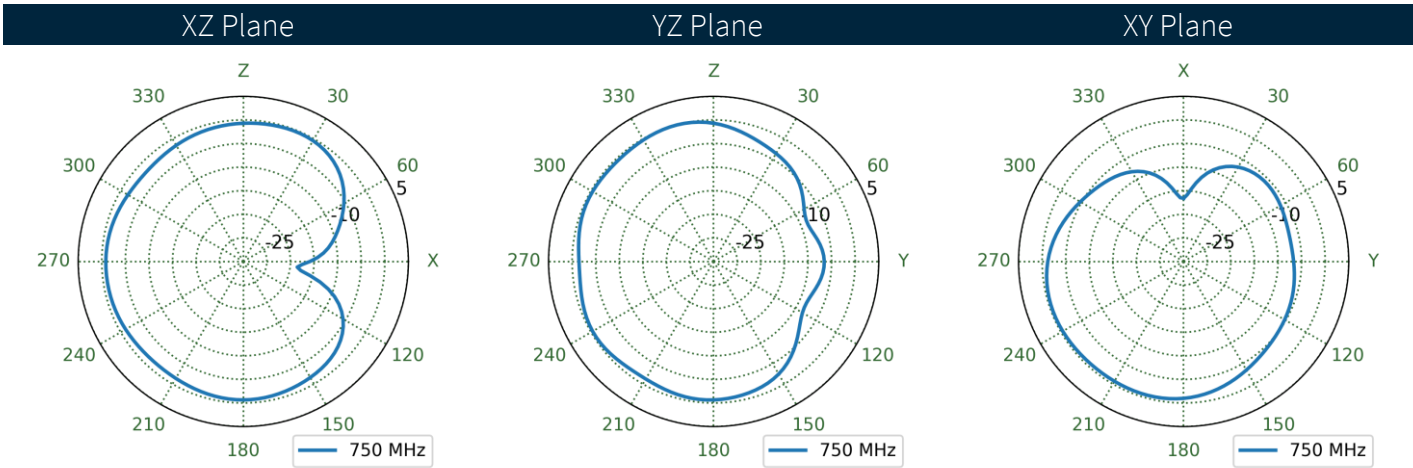
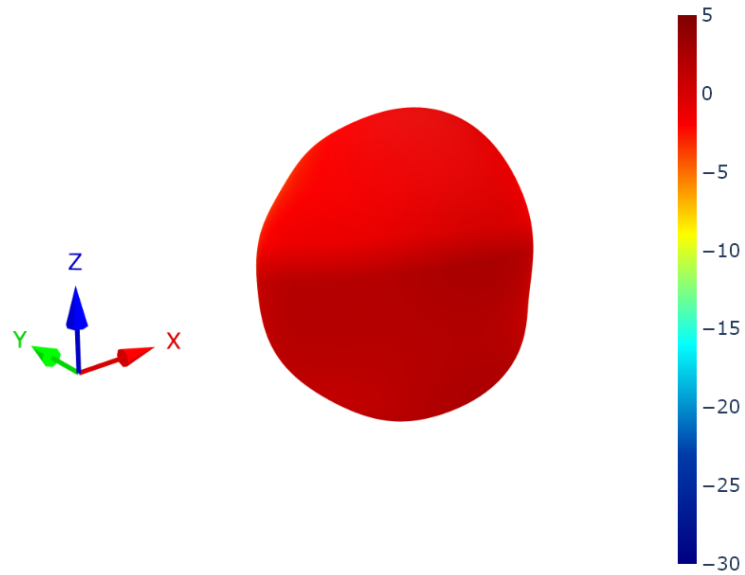

8.10 Antenna 1 Patterns at 890 MHz

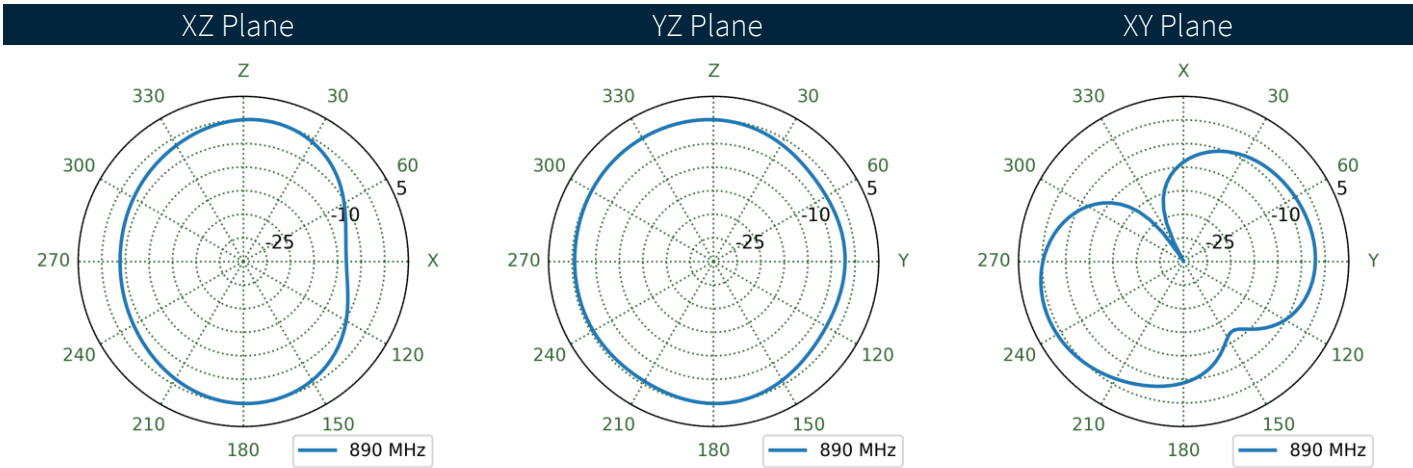
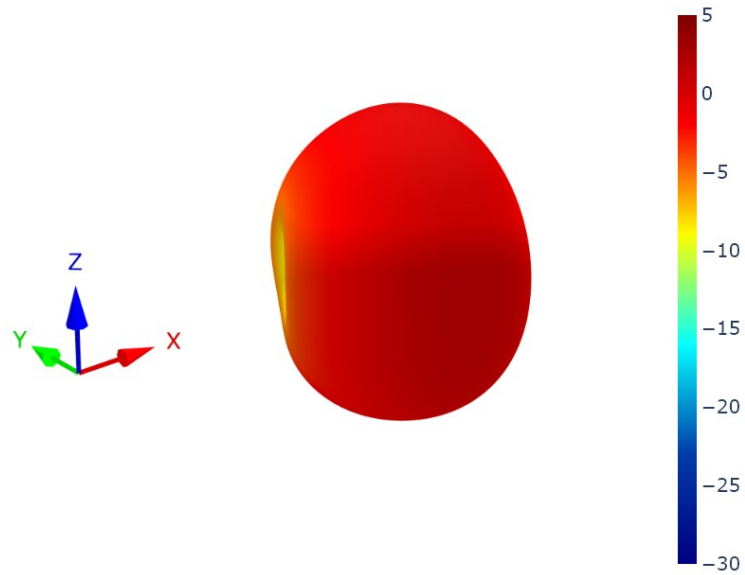

8.11 Antenna 2 Patterns at 890 MHz

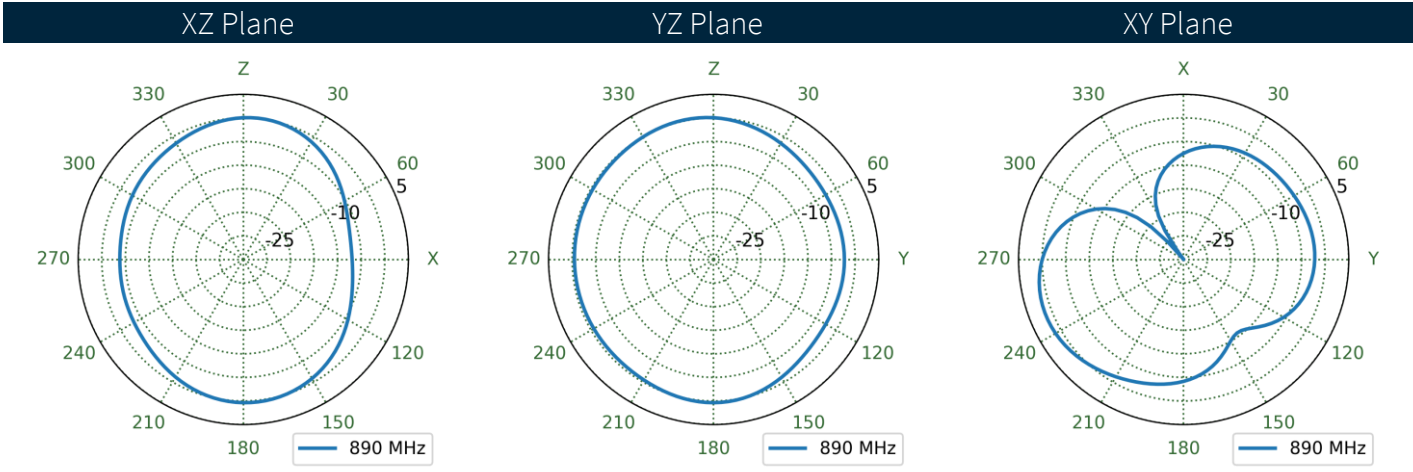
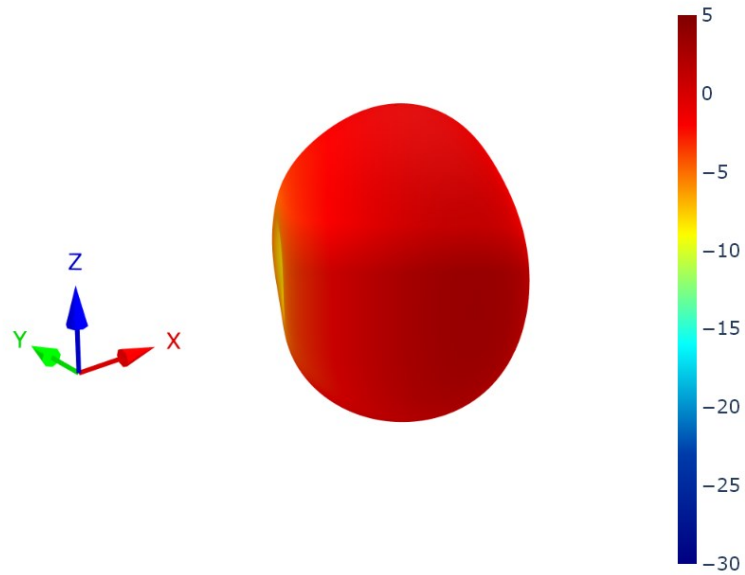

8.12 Antenna 3 Patterns at 890 MHz

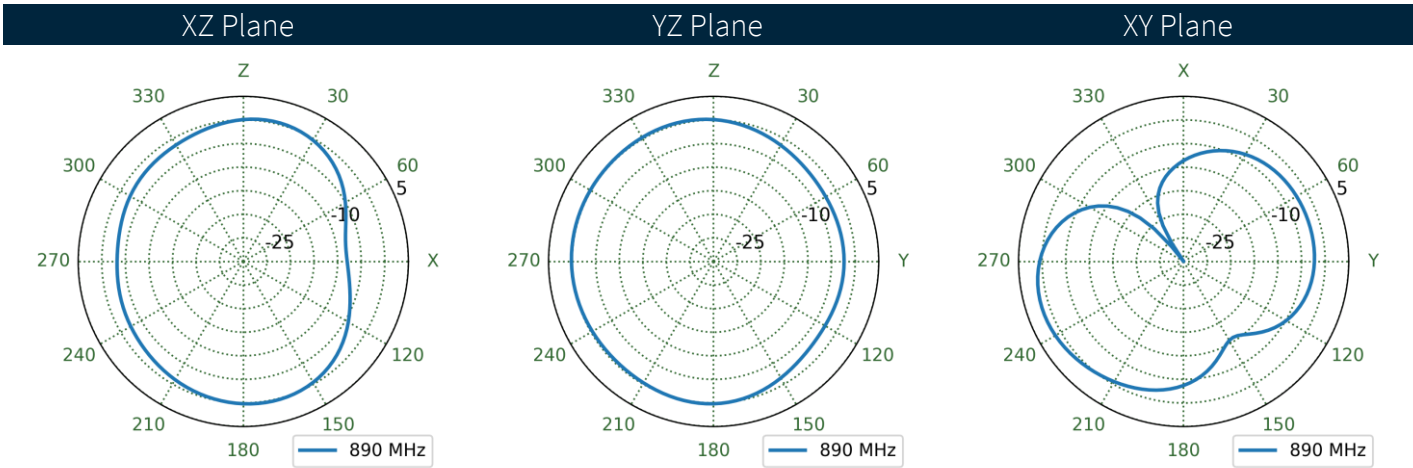
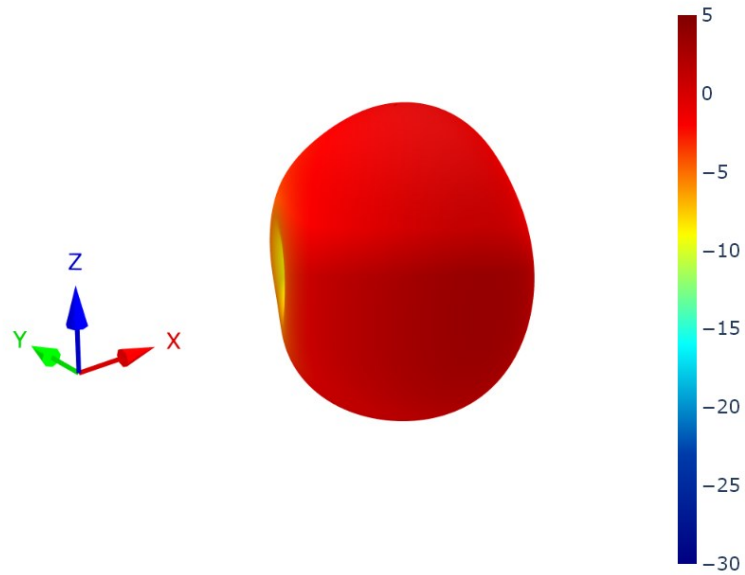

8.13 Antenna 4 Patterns at 890 MHz

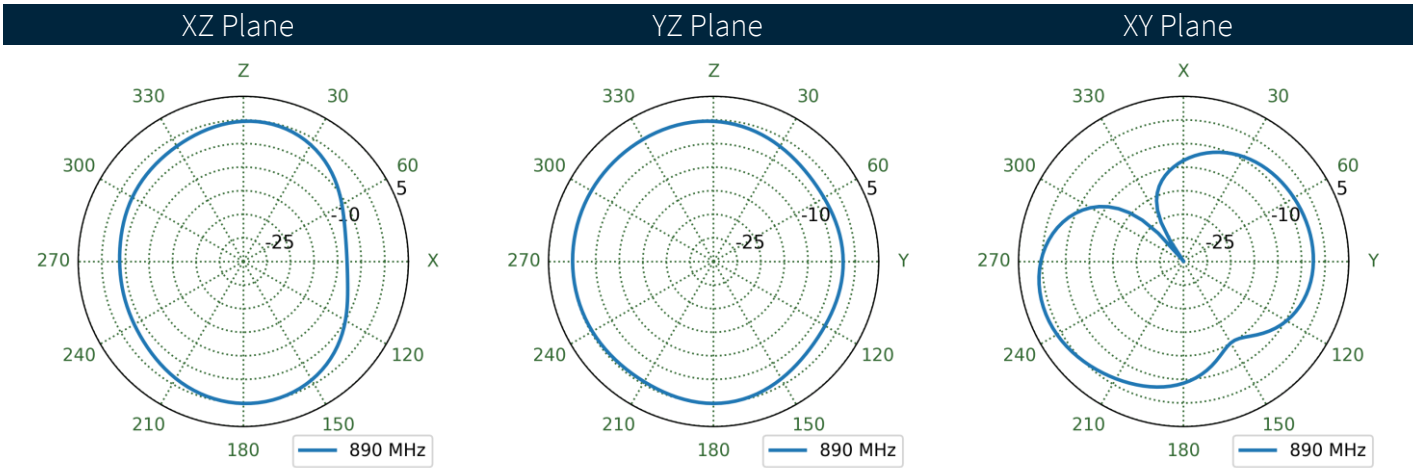
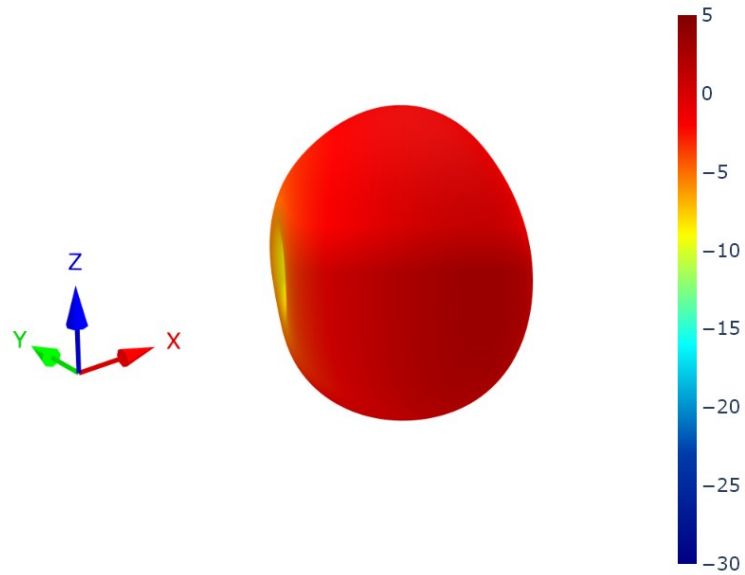

8.14 Antenna 1 Patterns at 1470 MHz

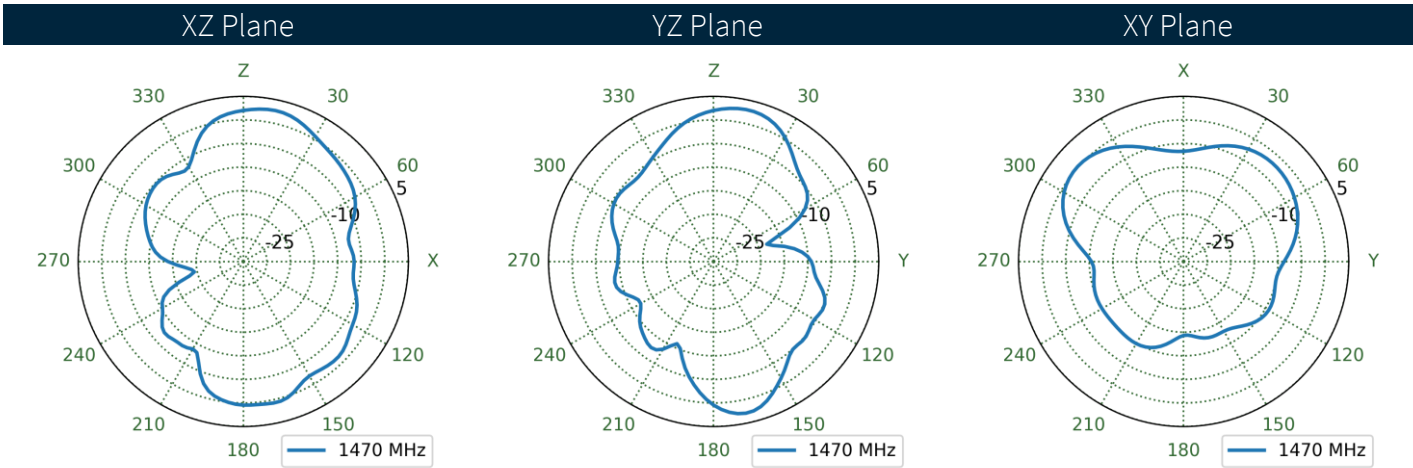
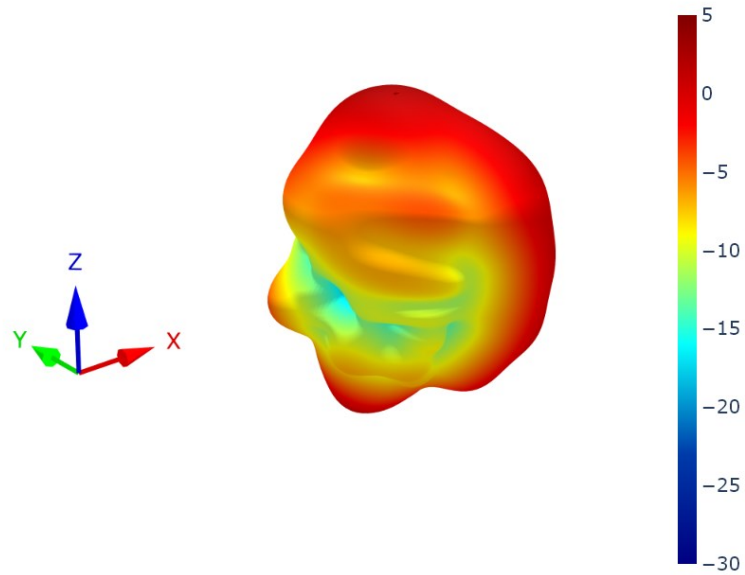

8.15 Antenna 2 Patterns at 1470 MHz

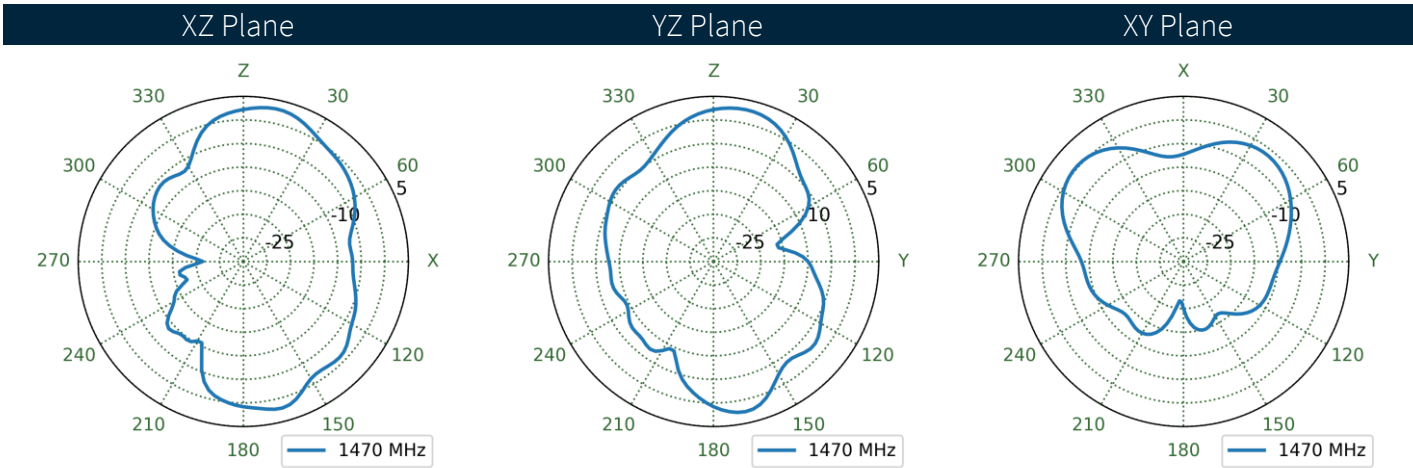
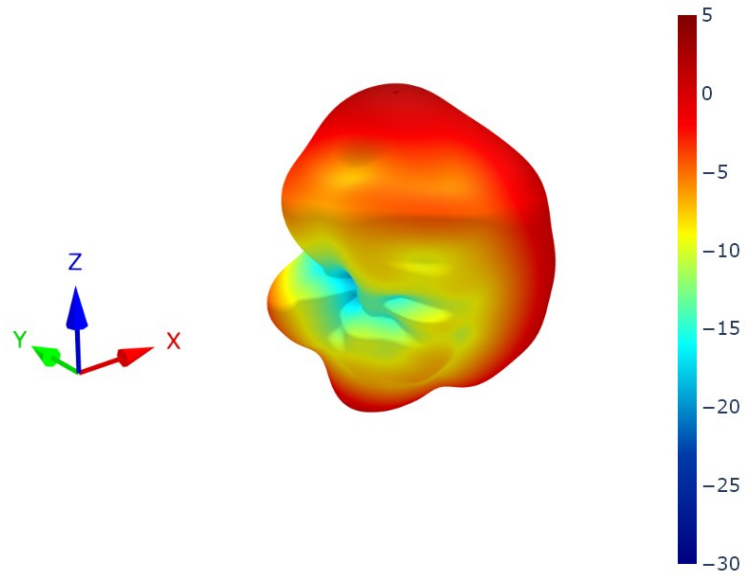

8.16 Antenna 3 Patterns at 1470 MHz

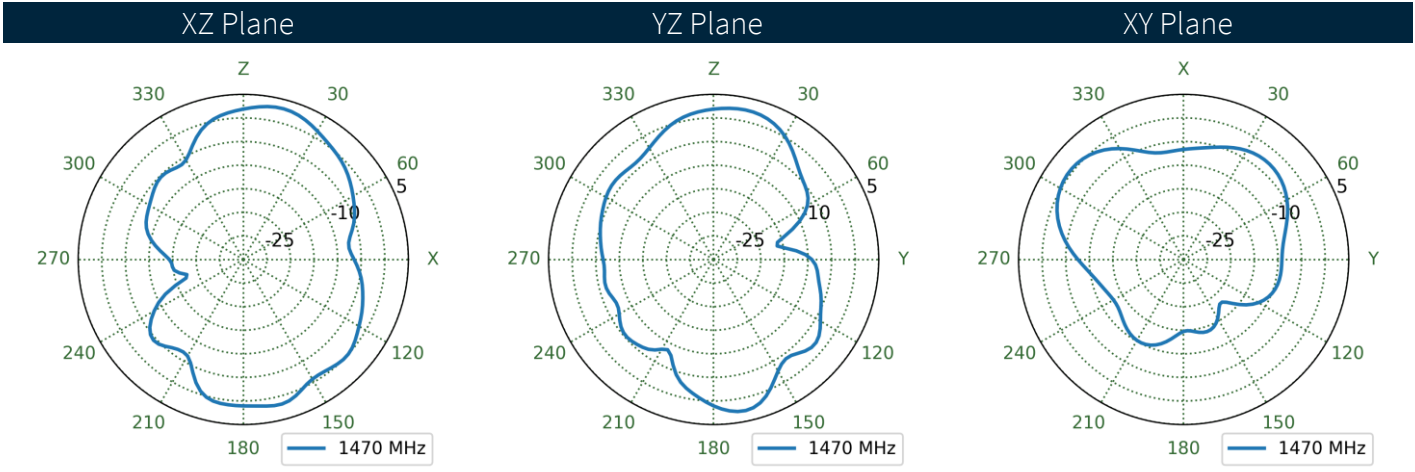
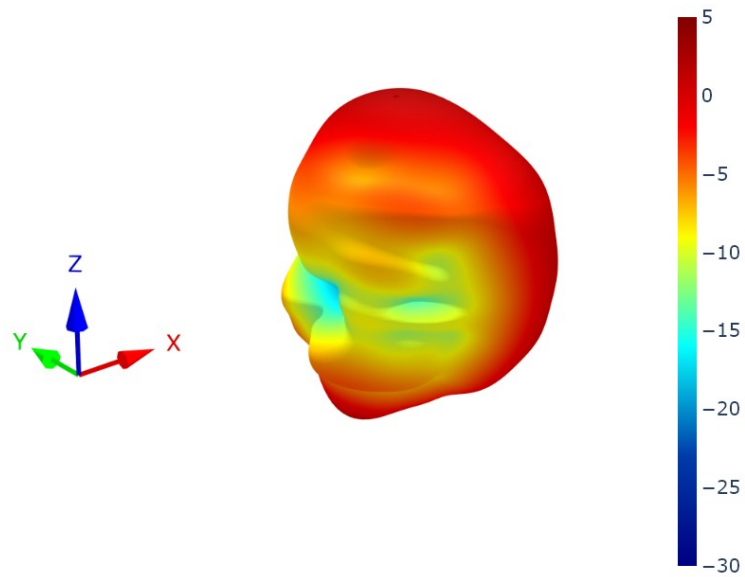

8.17 Antenna 4 Patterns at 1470 MHz

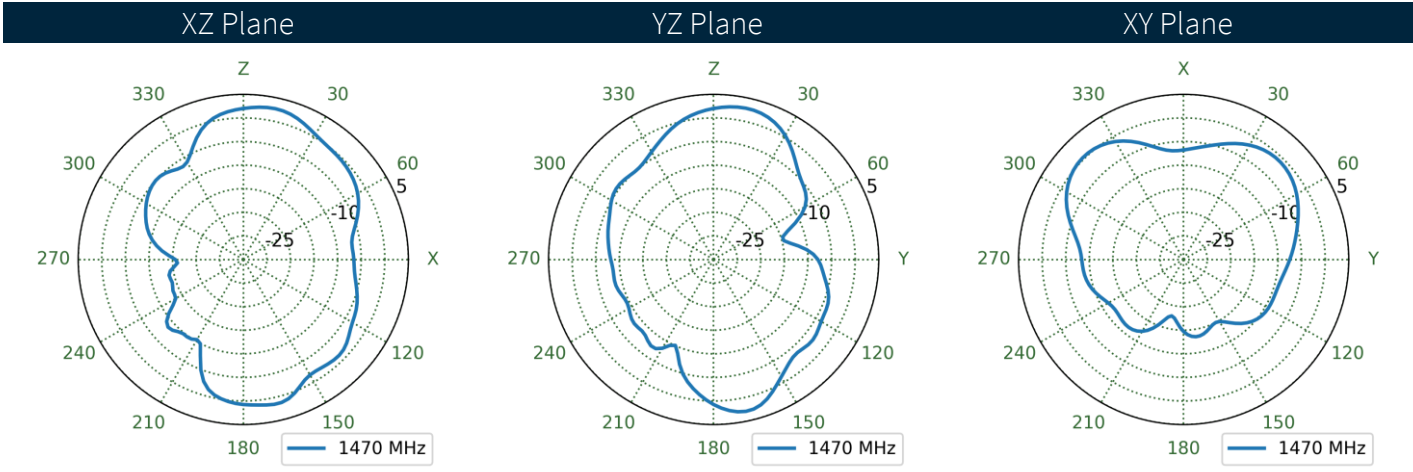
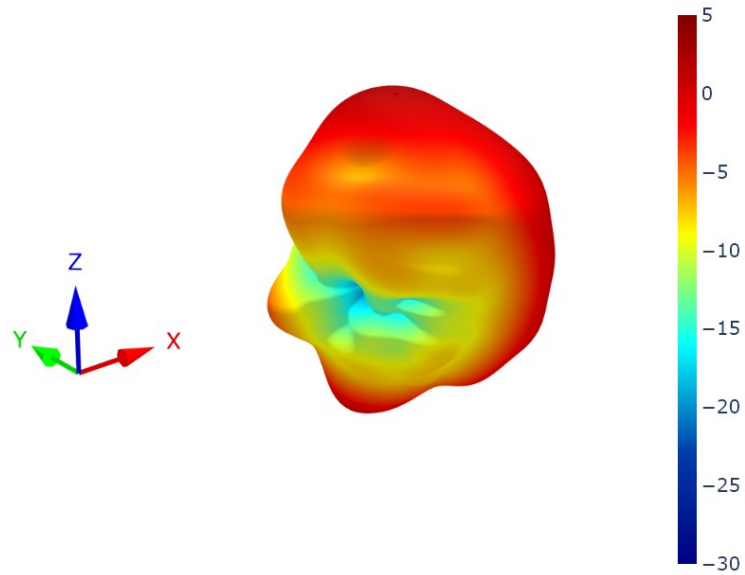

8.18 Antenna 1 Patterns at 1950 MHz

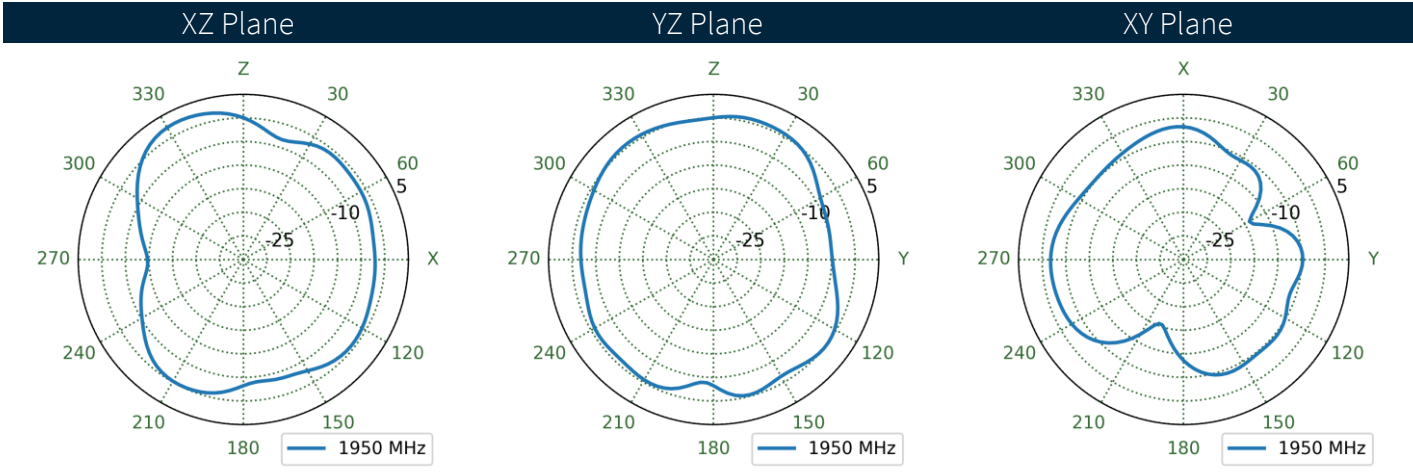
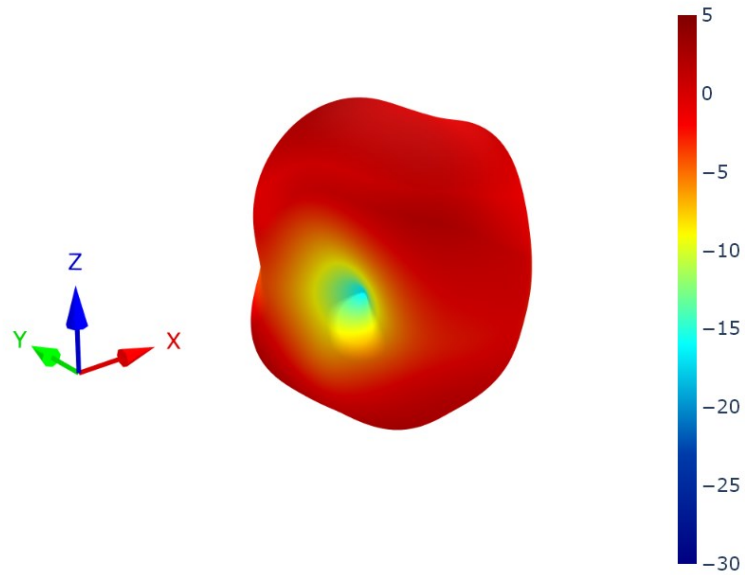

8.19 Antenna 2 Patterns at 1950 MHz

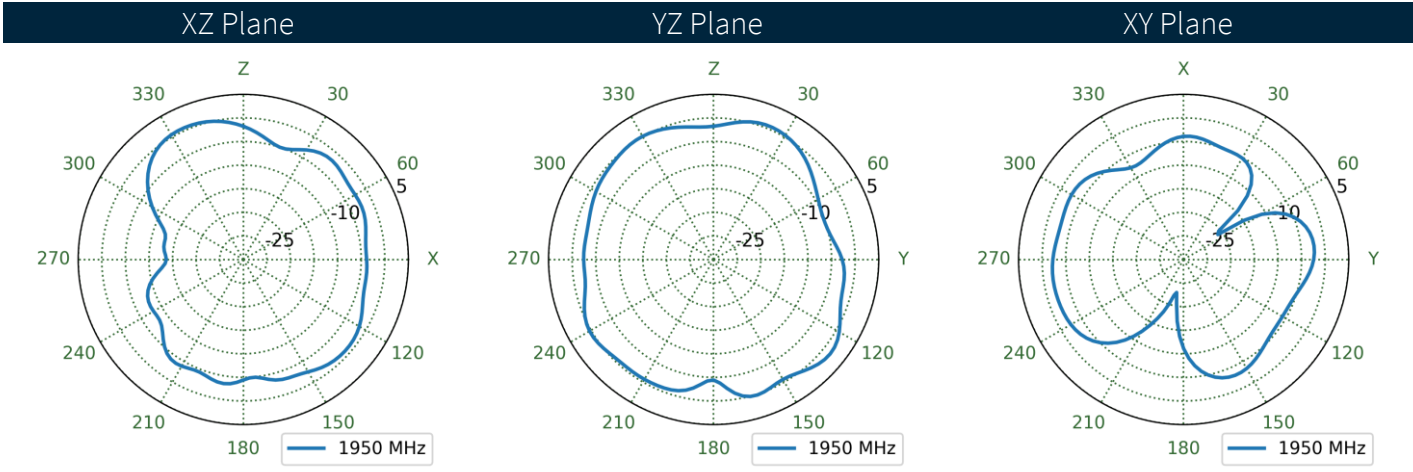
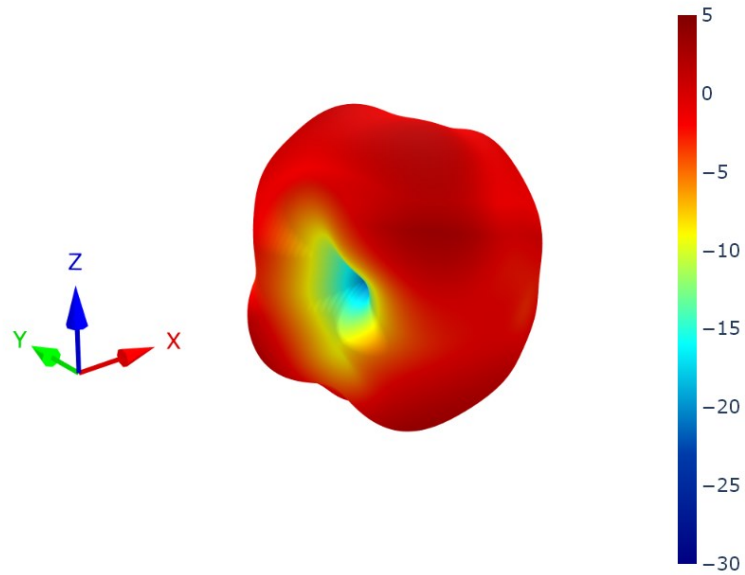

8.20 Antenna 3 Patterns at 1950 MHz

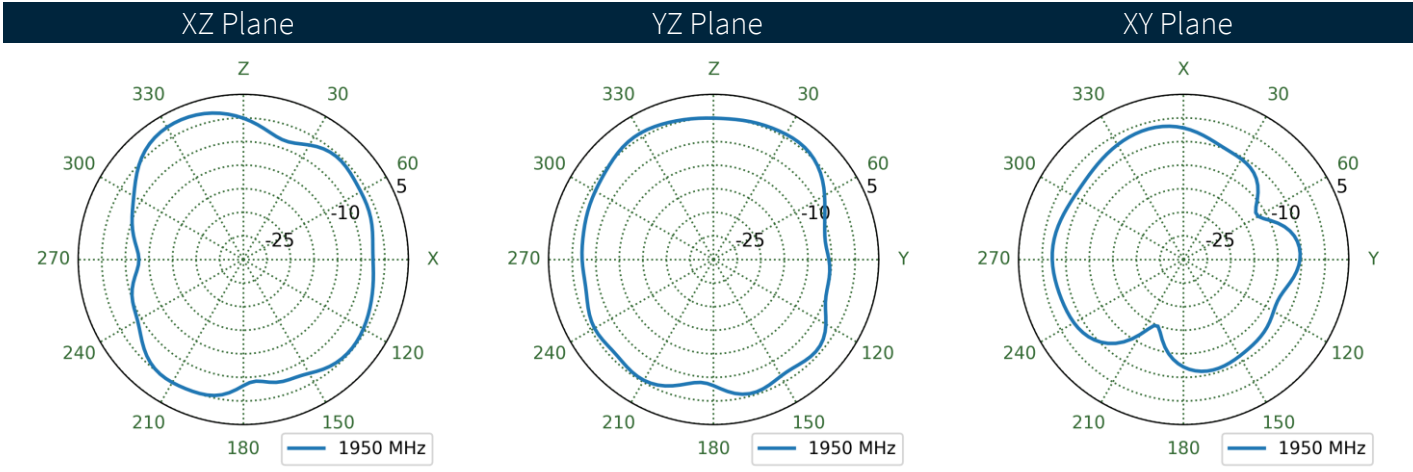
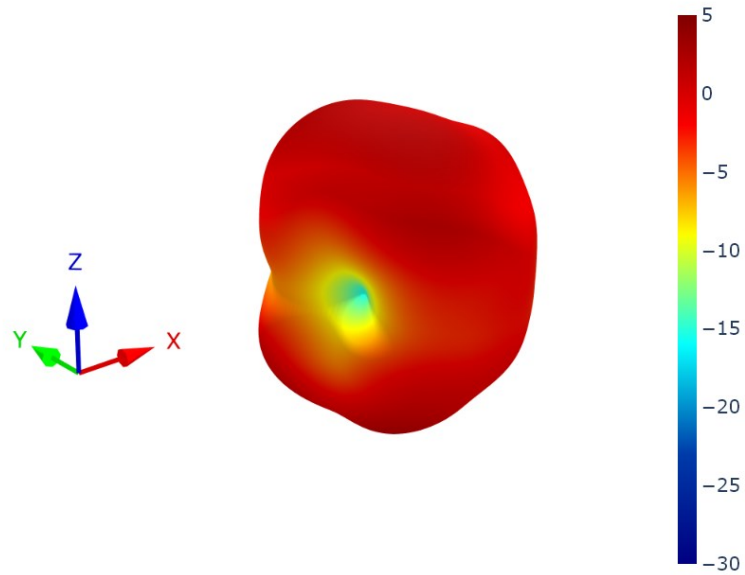

8.21 Antenna 4 Patterns at 1950 MHz

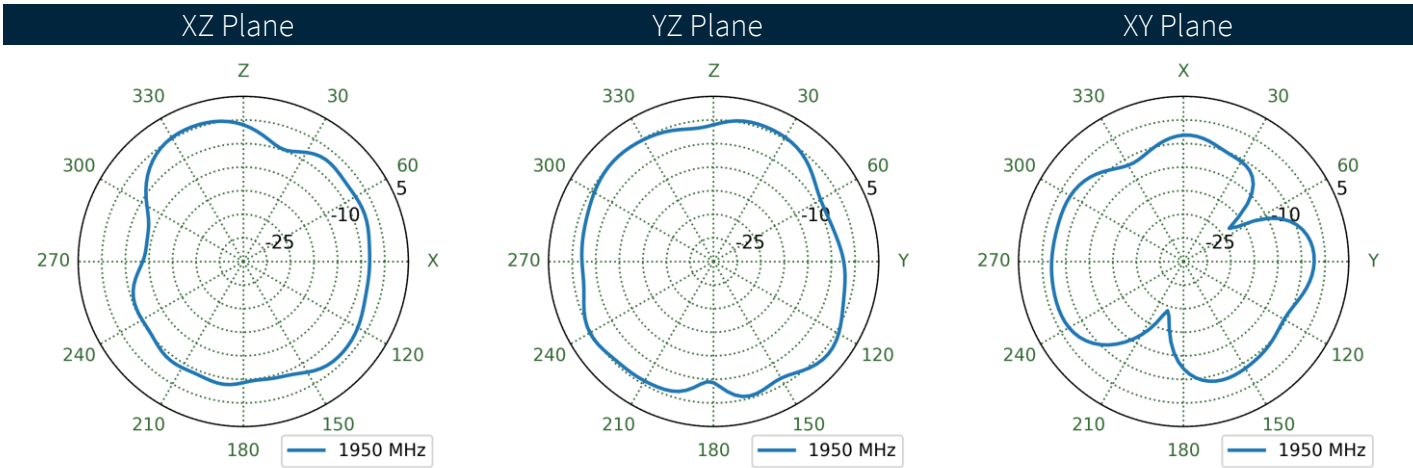
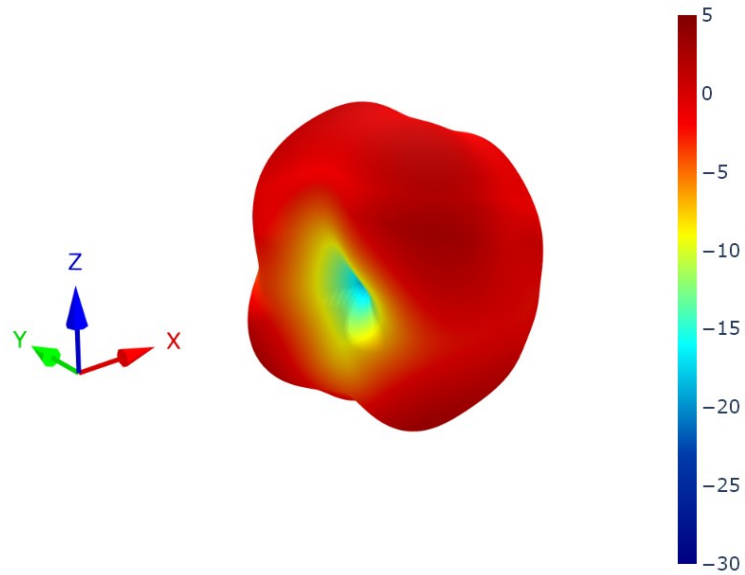

8.22 Antenna 1 Patterns at 2490 MHz

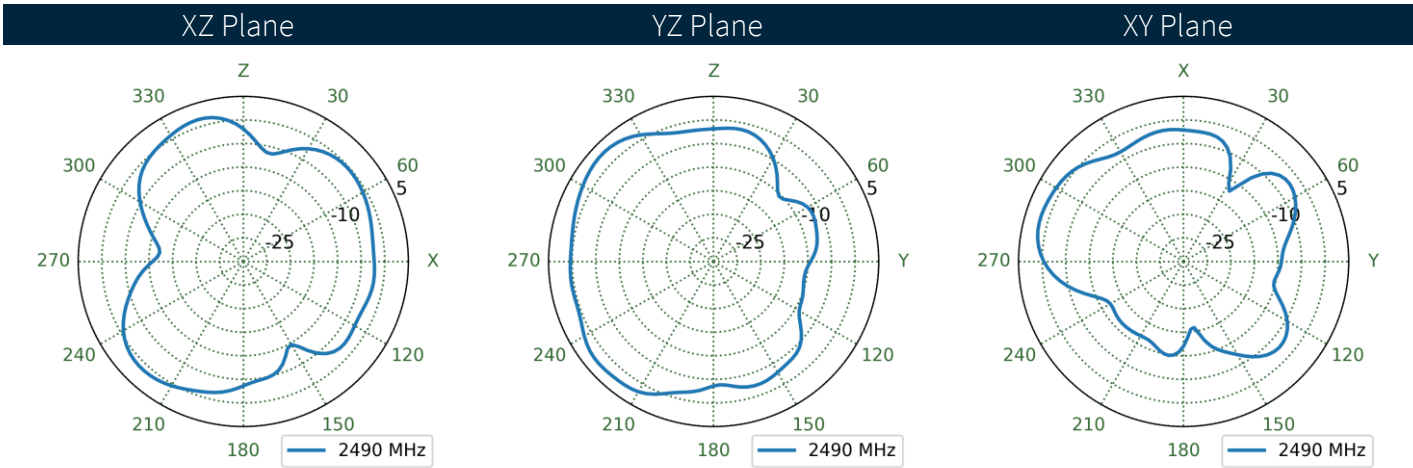
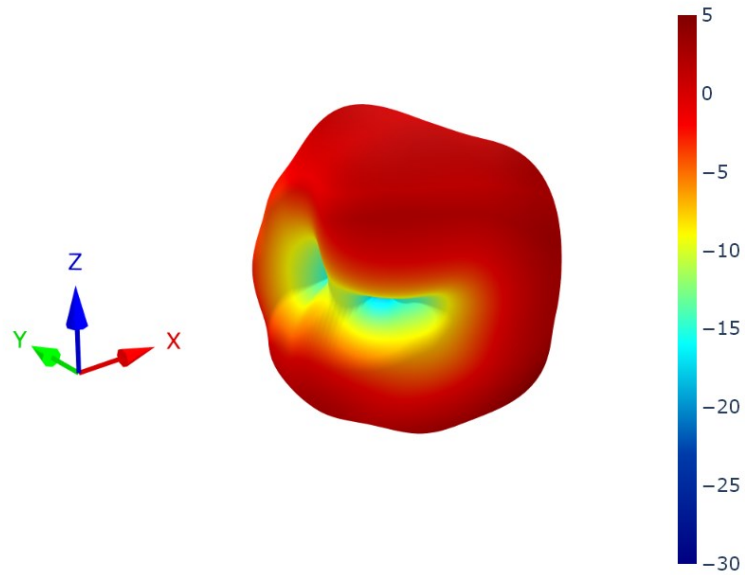

8.23 Antenna 2 Patterns at 2490 MHz

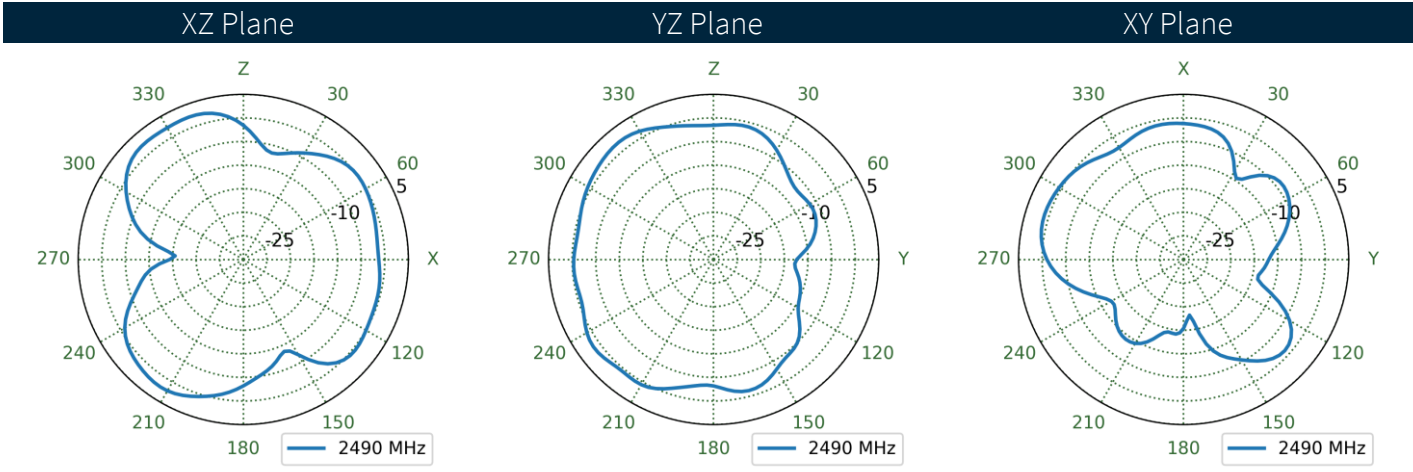
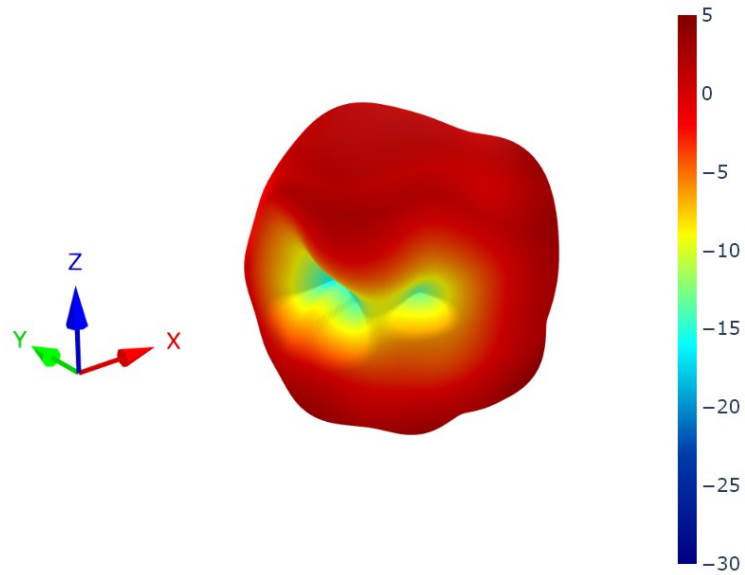

8.24 Antenna 3 Patterns at 2490 MHz

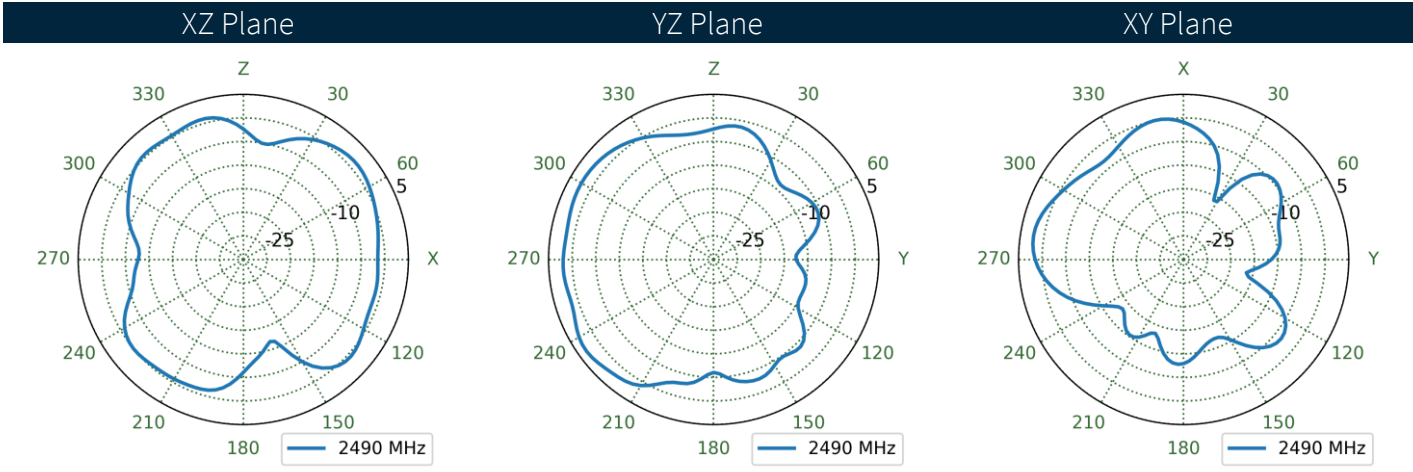
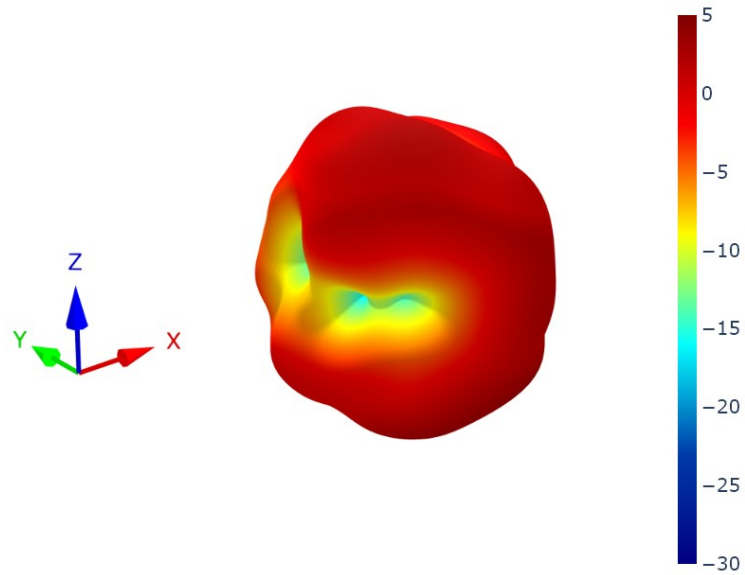

8.25 Antenna 4 Patterns at 2490 MHz

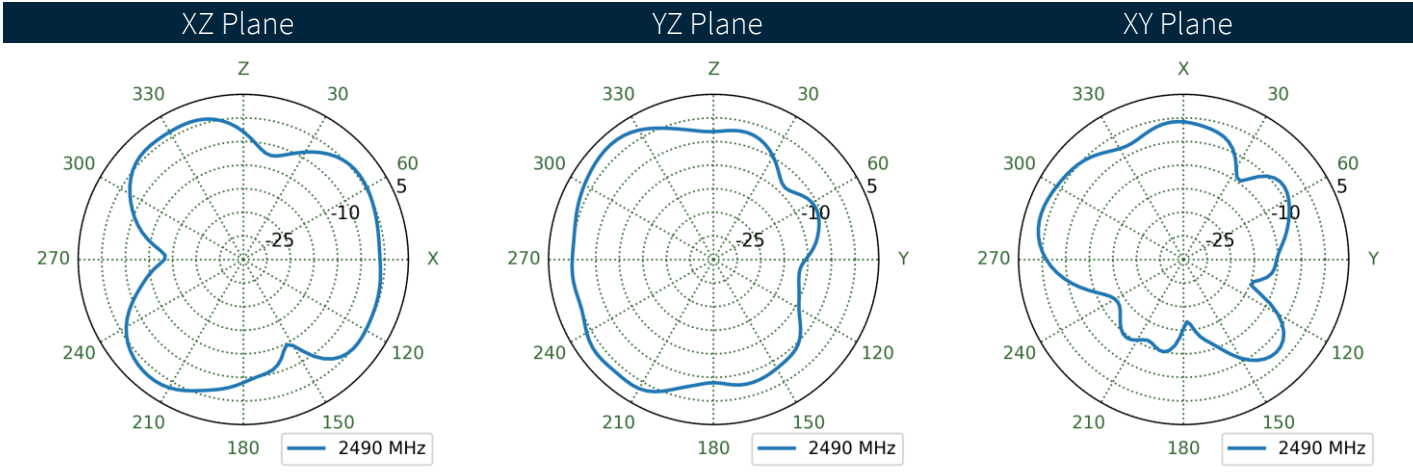
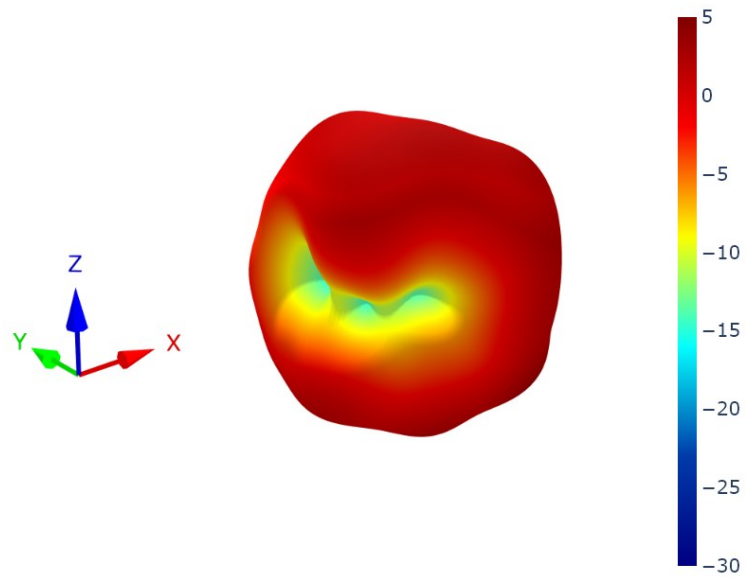

8.26 Antenna 1 Patterns at 4150 MHz

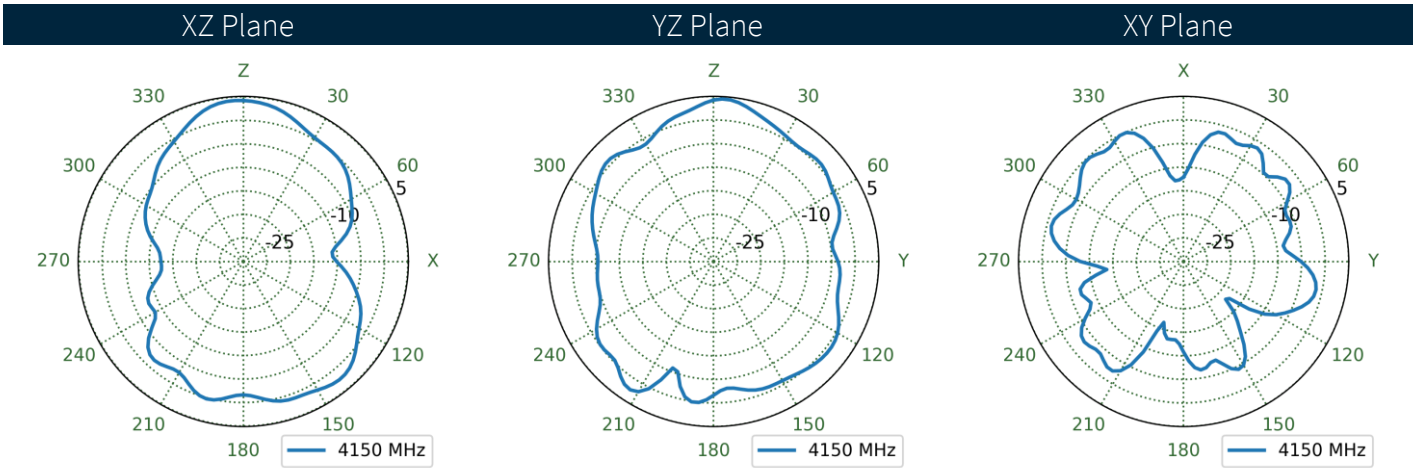
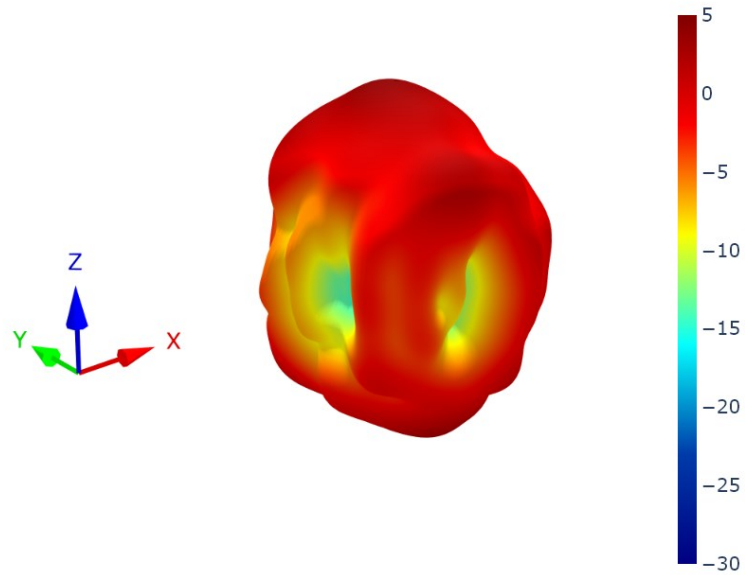

8.27 Antenna 2 Patterns at 4150 MHz

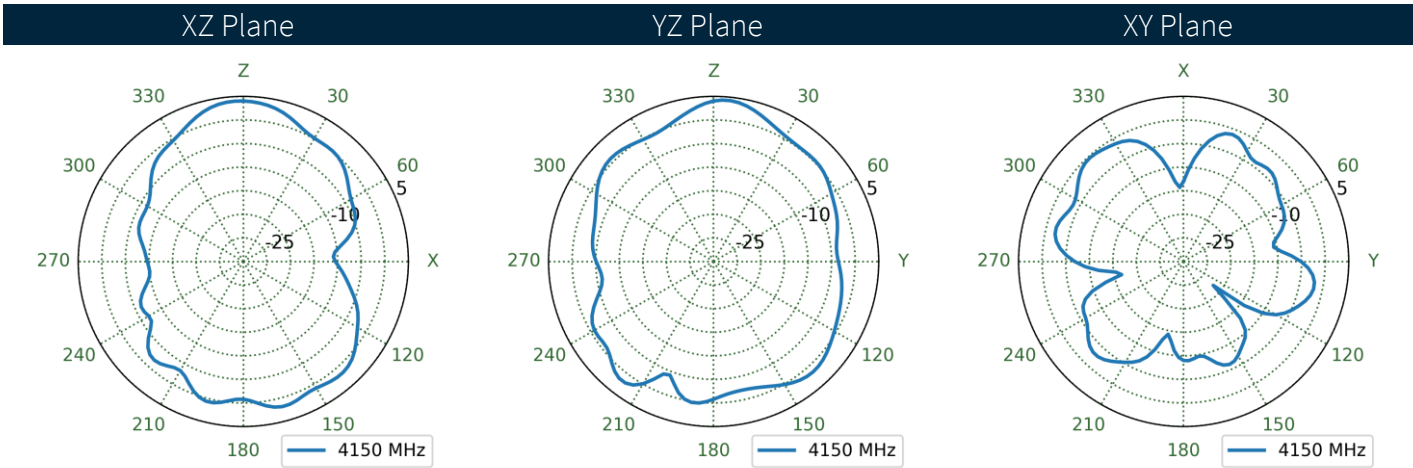
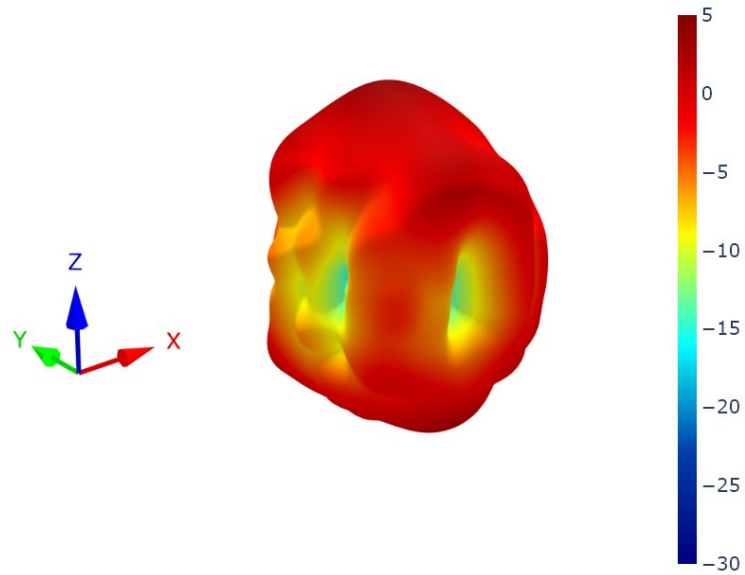

8.28 Antenna 3 Patterns at 4150 MHz

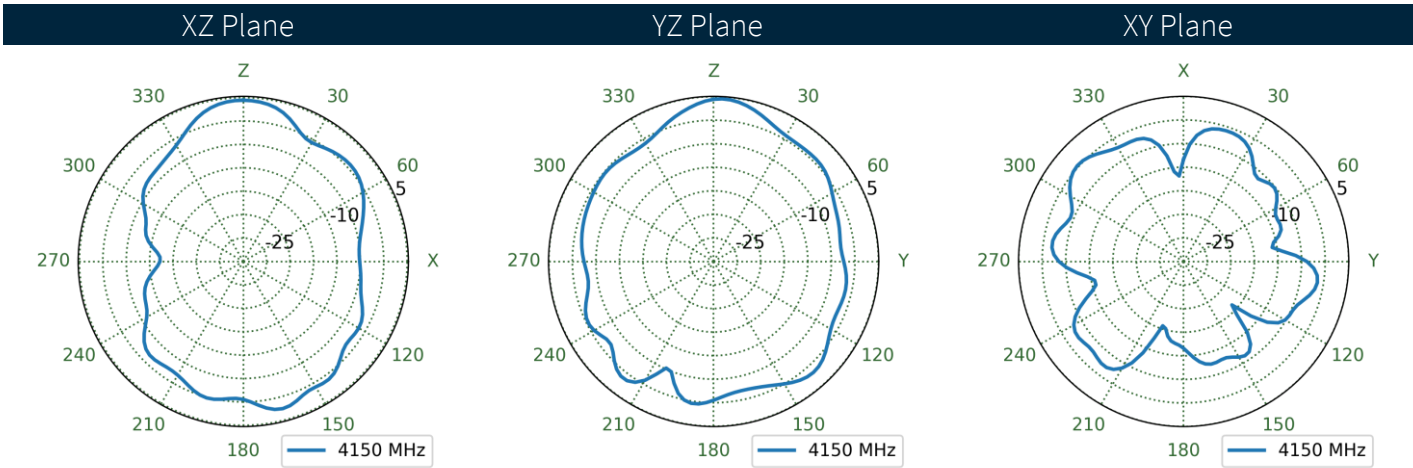
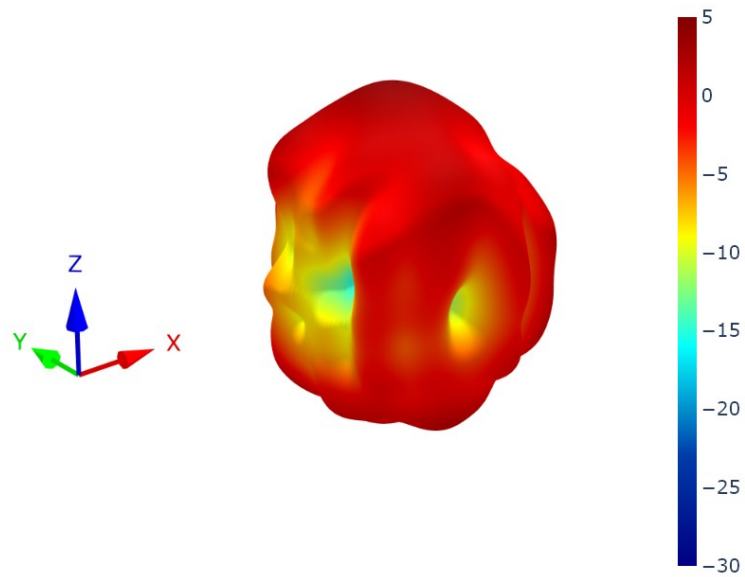

8.29 Antenna 4 Patterns at 4150 MHz

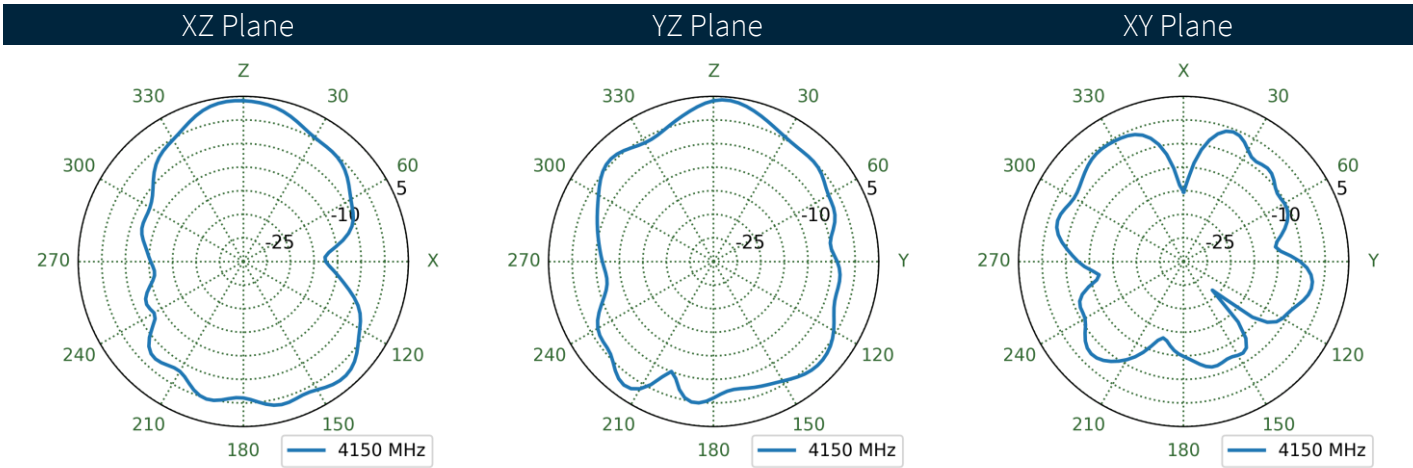
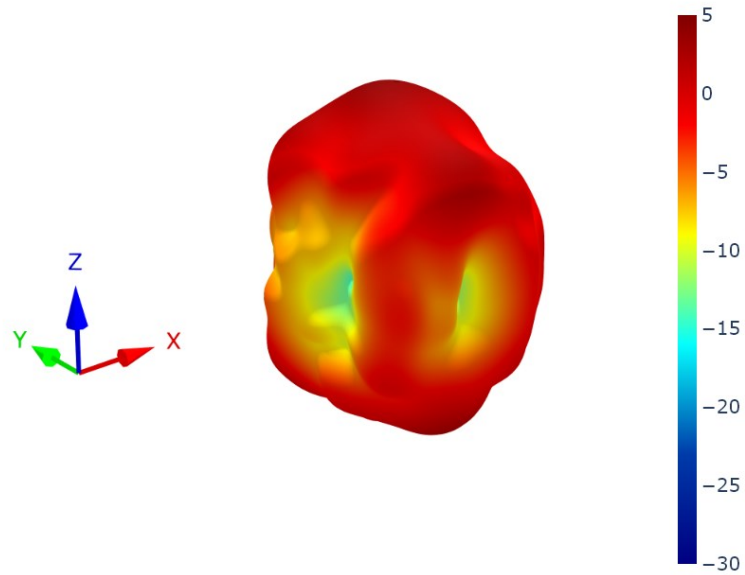

8.30 Antenna 1 Patterns at 5540 MHz

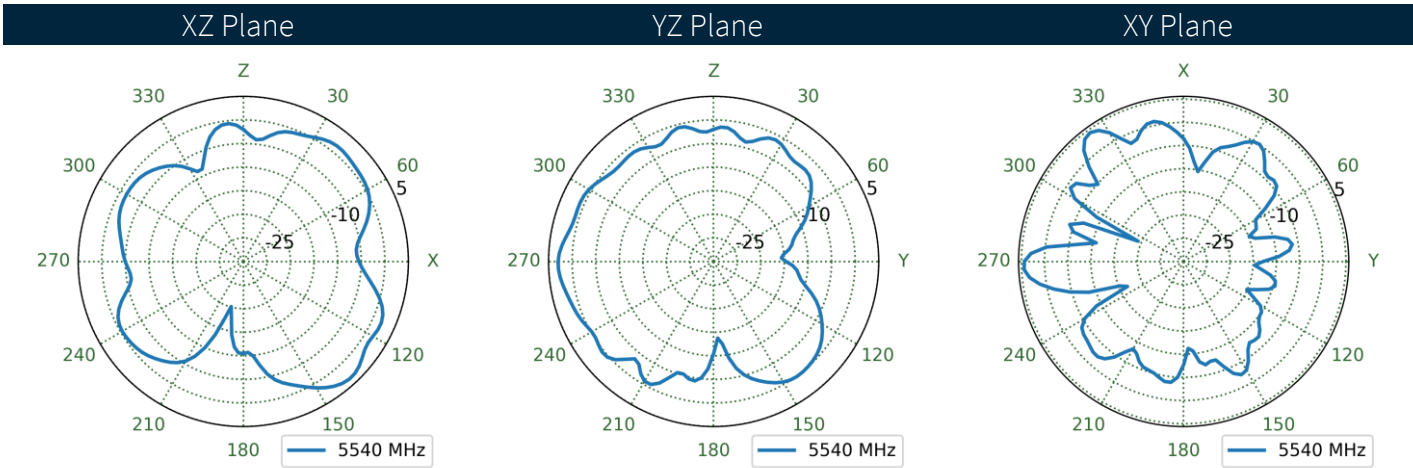
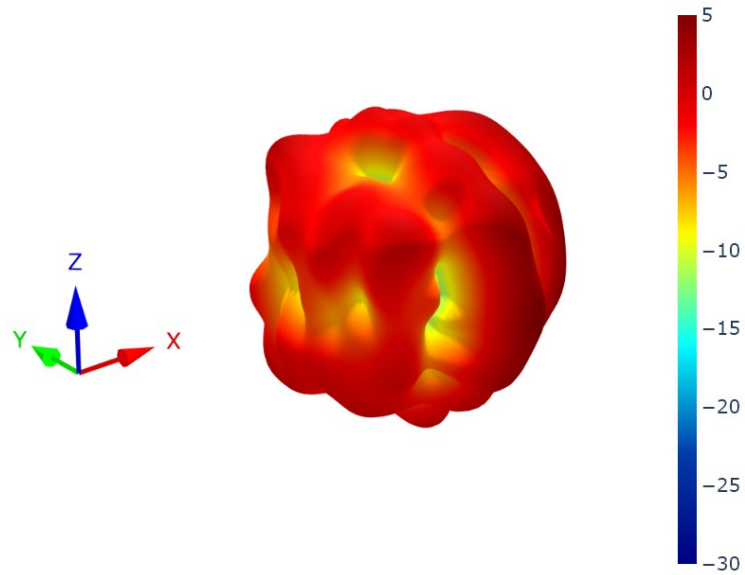

8.31 Antenna 2 Patterns at 5540 MHz

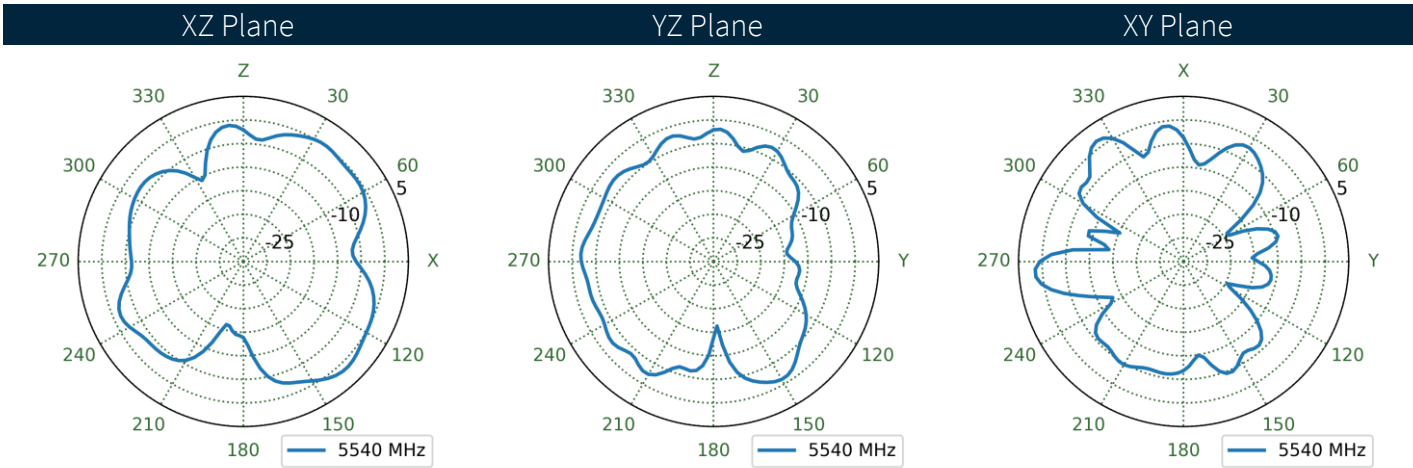
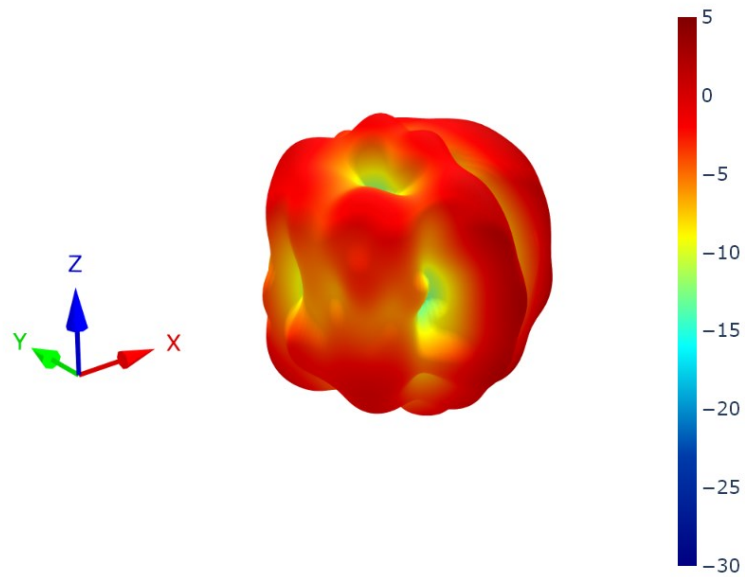

8.32 Antenna 3 Patterns at 5540 MHz

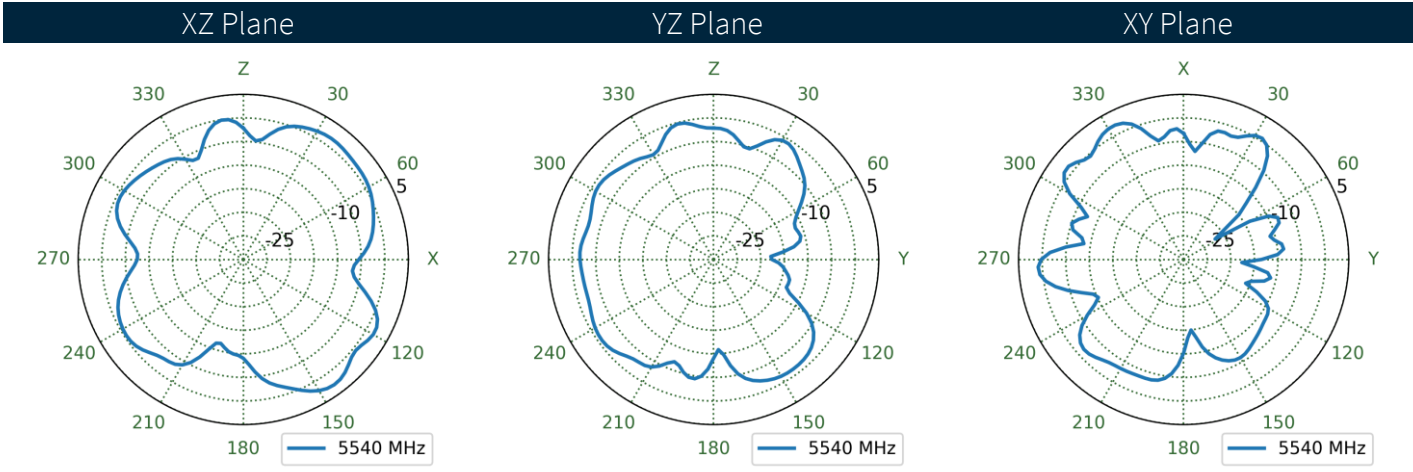
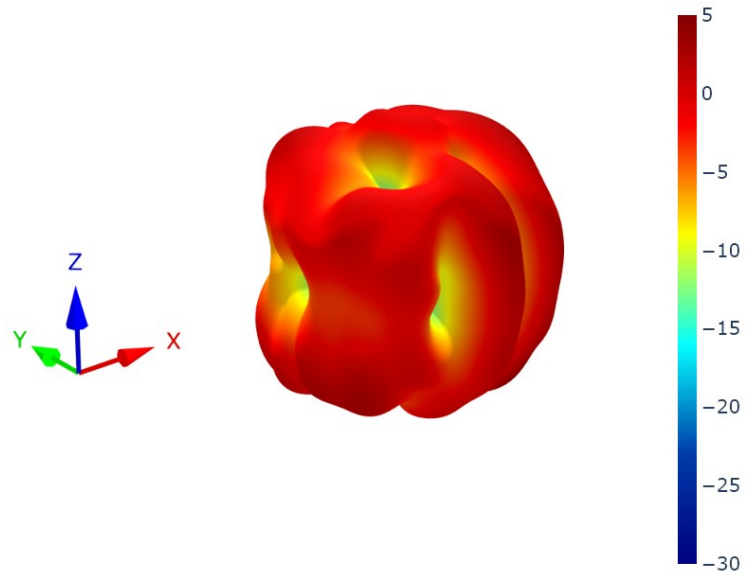

8.33 Antenna 4 Patterns at 5540 MHz

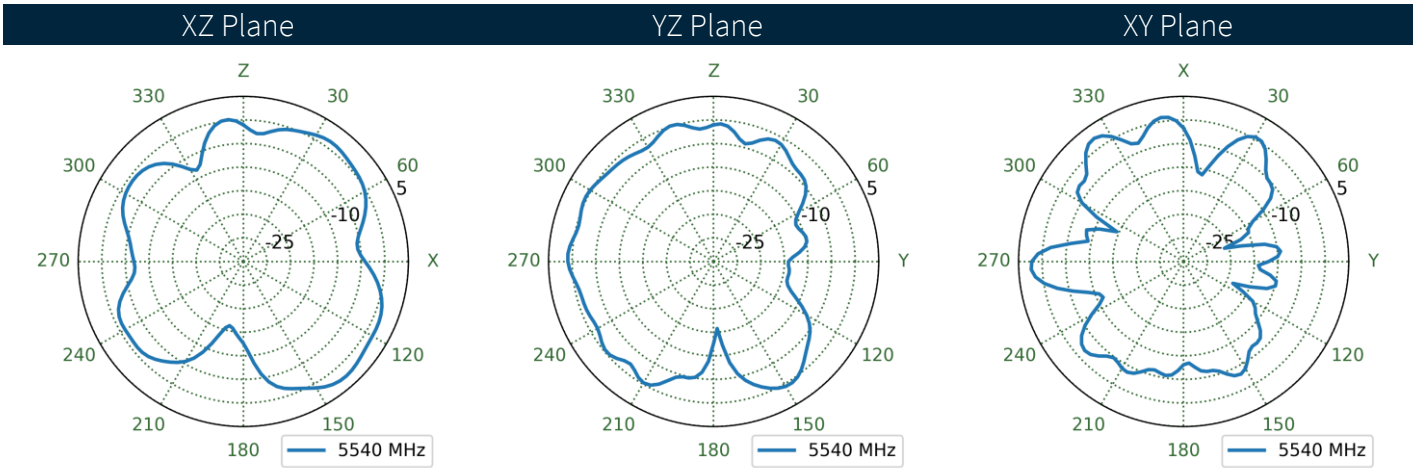
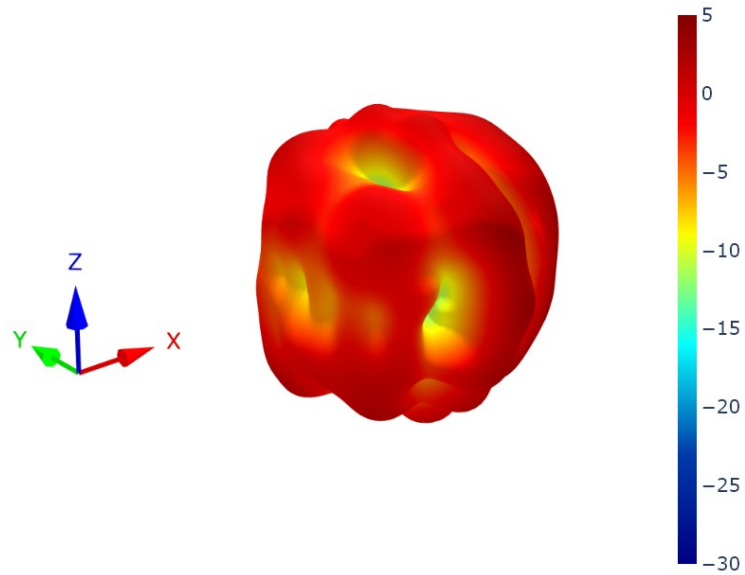

8.34 Antenna 1 Patterns at 6520 MHz

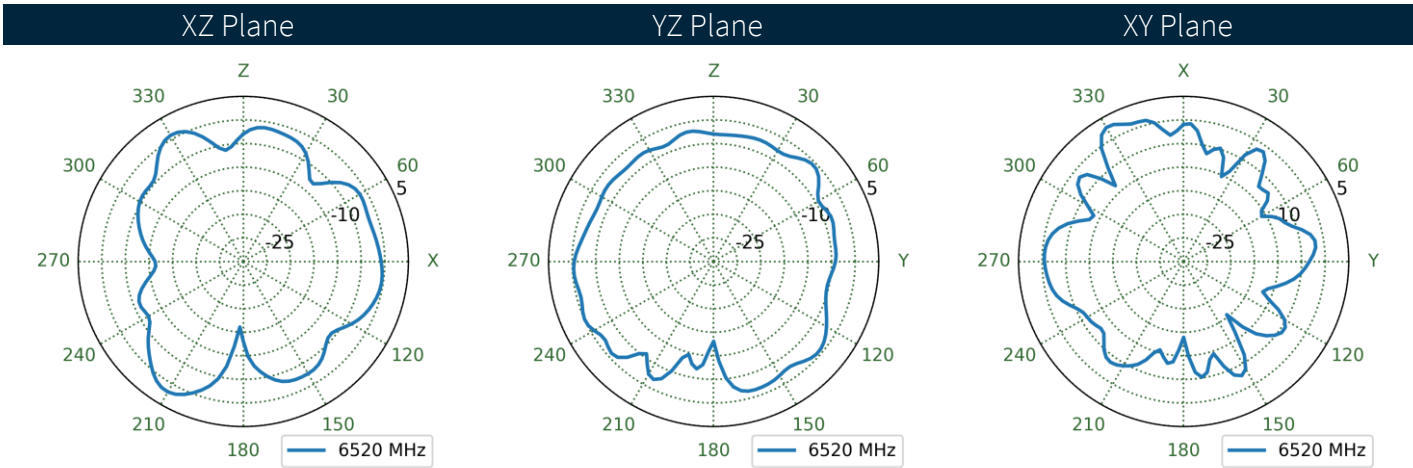
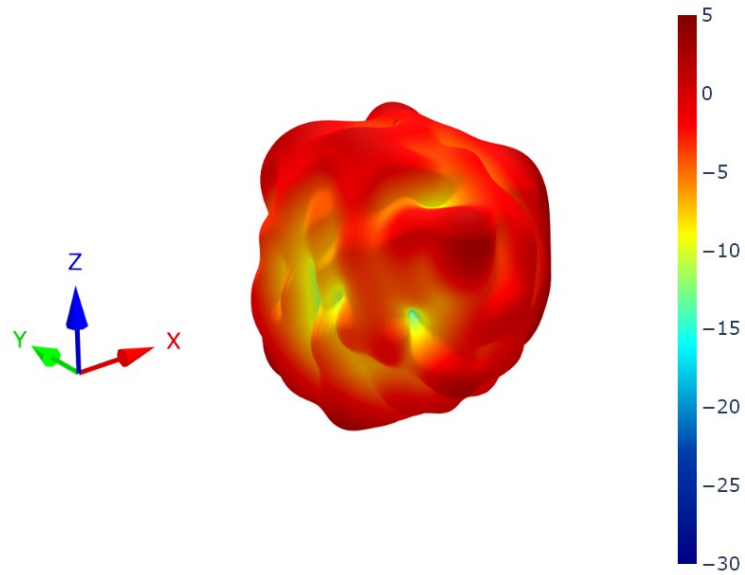

8.35 Antenna 2 Patterns at 6520 MHz

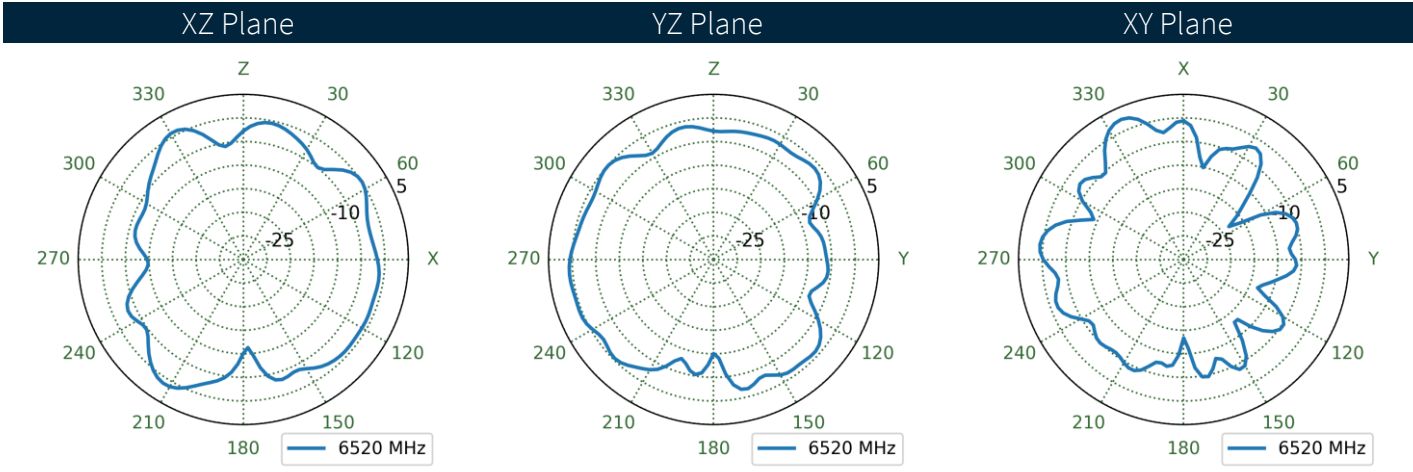
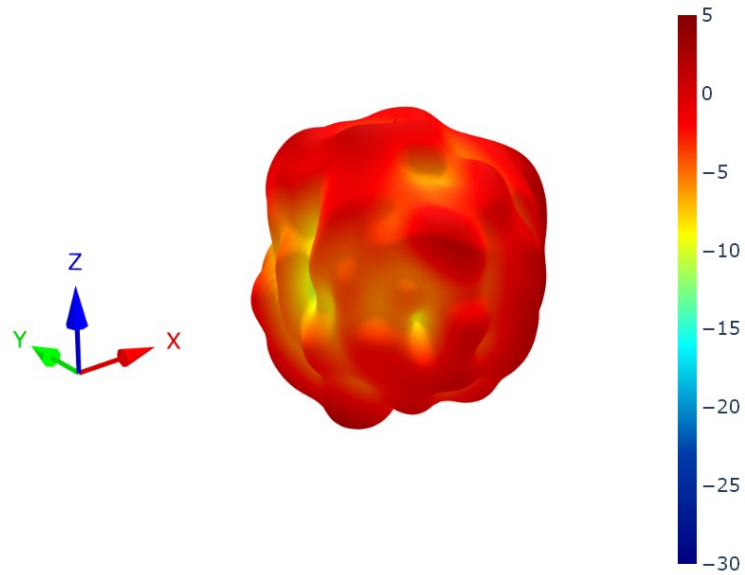

8.36 Antenna 3 Patterns at 6520 MHz

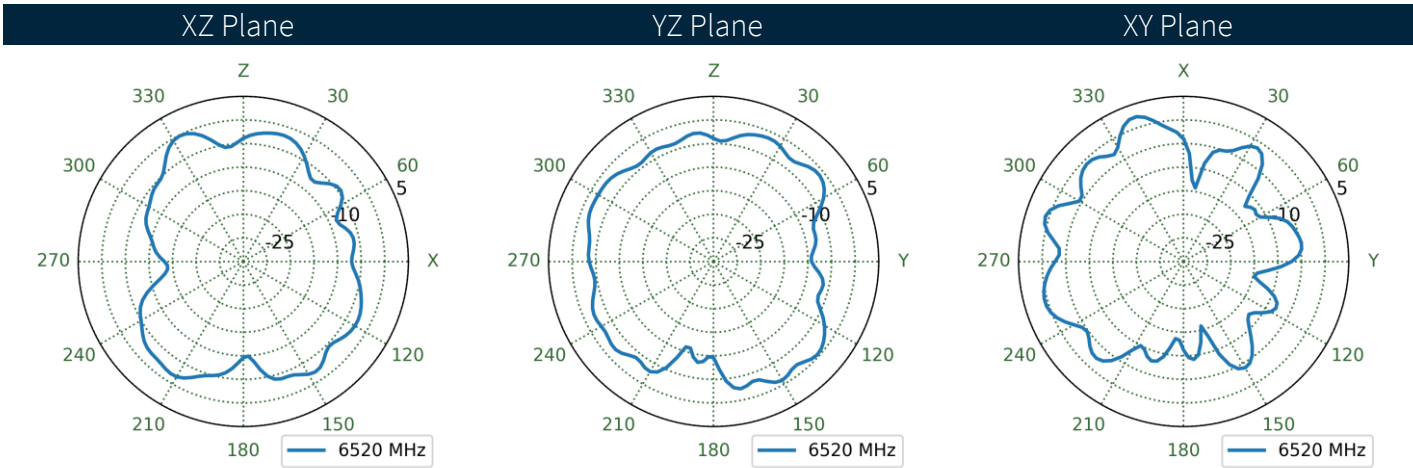
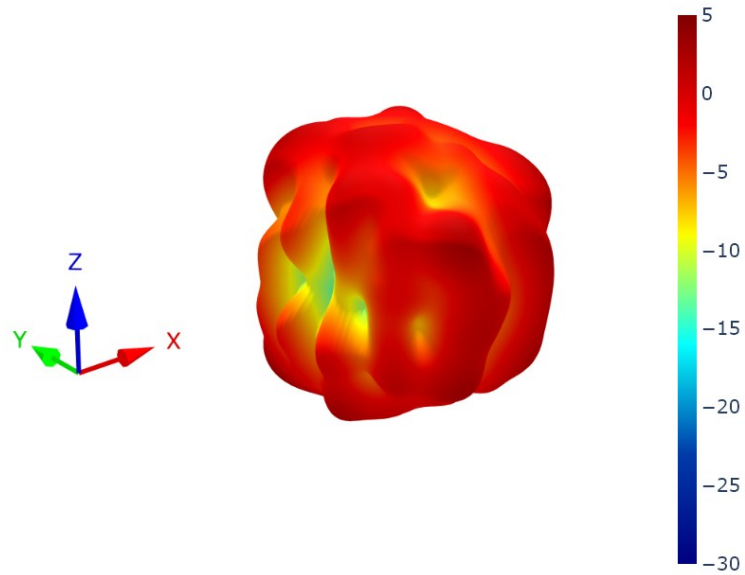

8.37 Antenna 4 Patterns at 6520 MHz

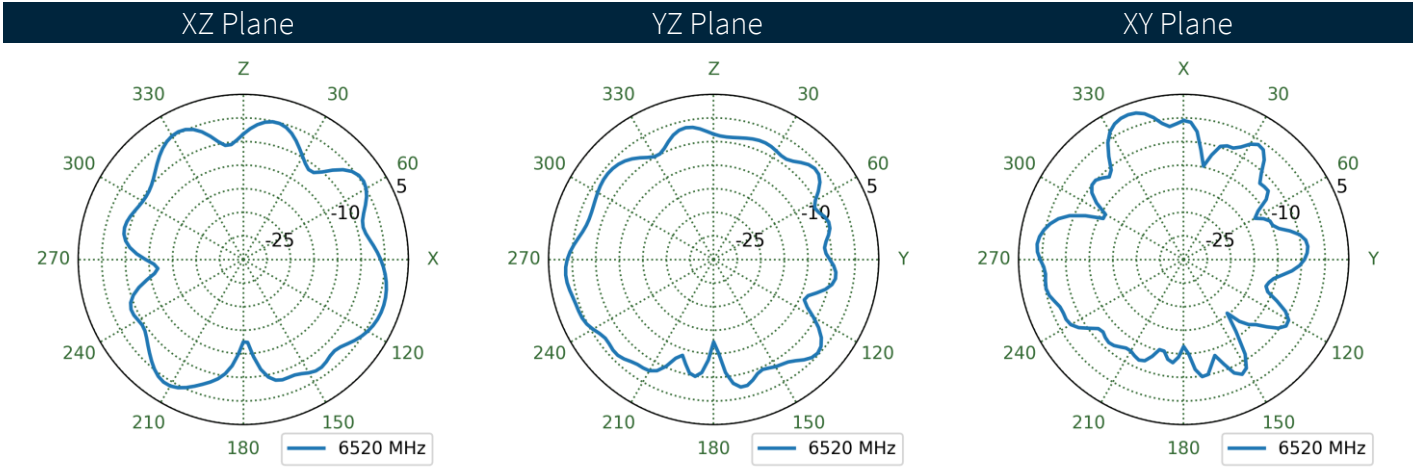
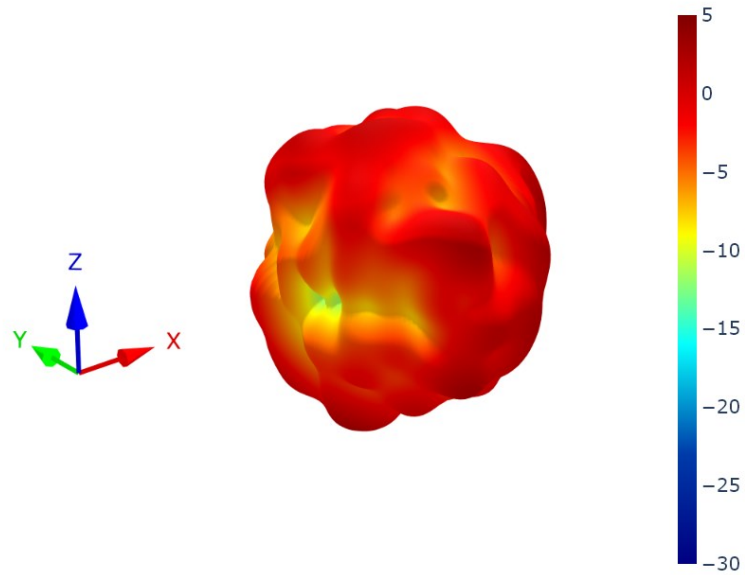

Changelog for the datasheet

SPE-24-8-075 – FXUB50.A.07.C.001

Revision: A (Original First Release)

Date: 2024-04-24

Notes: Initial Release.

Author: Gary West

Previous Revisions



www.taoglas.com

