



TAOGLAS®



Datasheet

Olympian III Series

Part No:
MA181.W.001

Description

Olympian III 3in1 White Screw Mount Combination Antenna
With GNSS and 4G/5G MIMO

Features:

- 2* 4G/5G MIMO
- 1* GPS-GLONASS-BeiDou Antenna
- IP67 Waterproof Enclosure
- Dims: \varnothing 59.45 x 70mm
- Cables: GNSS – 1M RG-174, 4G-5G – 1M TGC-1.5DS
- Connectors: SMA(M)
- Custom Cables and Connectors Available
- RoHS & Reach Compliant

1.	Introduction	3
2.	Specification	4
3.	Mechanical Drawing	9
4.	Packaging	10
5.	Antenna Characteristics	11
6.	Radiation Patterns	17
7.	LNA Characteristics	56
<hr/>		
	Changelog	59

Taoglas makes no warranties based on the accuracy or completeness of the contents of this document and reserves the right to make changes to specifications and product descriptions at any time without notice. Taoglas reserves all rights to this document and the information contained herein. Reproduction, use or disclosure to third parties without express permission is strictly prohibited.

Ireland & USA
ISO 9001:2015
Certified



Taiwan
ISO 9001:2015
Certified



1. Introduction



The Taoglas Olympian III, MA181 is a high performance 3-in-1 combination GNSS, 4G/5G MIMO permanent mount antenna in a compact housing at 70mm tall and 59mm in diameter. It is ideal for external use on vehicles and outdoor assets requiring GNSS, and Cellular MIMO connectivity.

The GPS/GLONASS/Galileo antenna has stable gain and radiation patterns on all bands. The 4G/5G antenna, covers all worldwide LTE bands, includes many sub 6GHz, 5G FR1 bands and also includes fallback to 3G/2G bands where required, especially improving the design to eliminate the cable radiation to make the antenna will not be impacted after installed on a metal box. This makes MA181 antenna can be mounted on metal and plastic structures, and both works well. Taoglas recommend a minimum of 1m cable lengths for stable antenna performance.

The IP67 rated enclosure is made from a durable, ASA material that makes it resistant to vandalism. An integrated rubber O-ring under the enclosure prevents water ingress under the antenna. It is mounted from the inside of the user device enclosure and the small thread allows for installation in situations where space is minimal.

Typical Applications Include:

- Smart Metering and Remote Monitoring
- Digital Signage
- Transportation and Telematics

Cable and connectors are customizable. The Olympian III, MA181 can be supplied with low loss TGC-200 cable extensions for longer cable runs and also it is available in black (MA181.A.001). Please contact your regional Taoglas customer support team for further information.

2. Specification

GNSS Frequency Bands					
GPS	L1 1575.42 MHz	L2 1227.6 MHz	L5 1176.45 MHz		
	■	□	□		
GLONASS	G1 1602 MHz	G2 1248 MHz	G3 1207 MHz		
	■	□	□		
Galileo	E1 1575.24 MHz	E5a 1176.45 MHz	E5b 1201.5 MHz	E6 1278.75 MHz	
	■	□	□	□	
BeiDou	B1C 1575.42 MHz	B1I 1561 MHz	B2a 1176.45 MHz	B2b 1207.14 MHz	B3 1268.52 MHz
	■	■	□	□	□
L-Band	L-Band 1542 MHz				
	□				
QZSS (Regional)	L1 1575.42 MHz	L2C 1227.6 MHz	L5 1176.45 MHz	L6 1278.75e6	
	■	□	□	□	
IRNSS (Regional)	L5 1176.45 MHz				
	□				
SBAS	L1/E1/B1 1575.42 MHz	L5/B2a/E5a 1176.45 MHz	G1 1602 MHz	G2 1248 MHz	G3 1207 MHz
	■	□	■	□	□

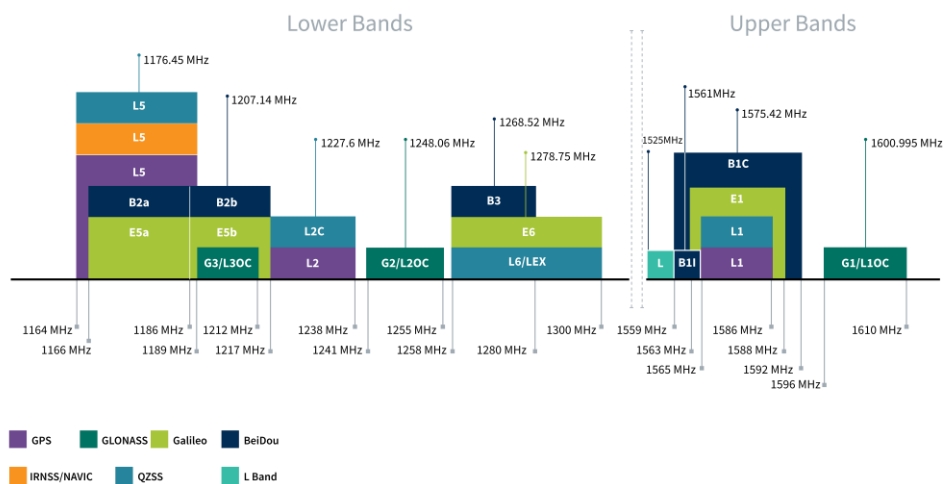

GNSS Bands and Constellations

GNSS Electrical			
Frequency (MHz)	1561	1575.42	1603
VSWR (max.)	2:1	2:1	3:1
Passive Efficiency (%)	43.5	39.6	32.4
Passive Peak Gain (dBi)	2.4	0.6	1.1
Passive Average Gain (dB)	-3.6	-4.0	-4.9
Axial Ratio (dB)	13.32	20.53	30.38
Polarization	RHCP		
Impedance	50 Ω		
*Results shown are tested in Free Space with cable losses removed			

LNA and Filter Electrical Properties			
Frequency (MHz)	1561	1575.42	1603
Gain(dB)	31.3	30.9	29.7
Noise Figure(dB)	3.09	2.76	2.91
Group Delay(ns)	41.8	29.1	32.5
Out Of Band Rejection	70dB @ <1GHz 60dB @ >1.7GHz		
ESD Protection (IEC61000-4-2)	± 25 kV air / ± 20 kv contact discharge		
Voltage in (V)	+ 1.8 to 5.5		
Current Consumption (mA)	9 \pm 3		

4G-5G Electrical									
Band	Frequency (MHz)	Measurement	Efficiency (%)	Average Gain (dB)	Peak Gain (dBi)	Impedance	Polarization	Radiation Pattern	Max. input power
5G NR/4G Band 71	617-698	4G-5G 1 Free Space	40.4	-3.94	2.34	50 Ω	Linear	Omni-directional	10W
		4G-5G 1 Ground Plane	39.3	-4.06	2.10				
		4G-5G 2 Free Space	53.2	-2.74	3.08				
		4G-5G 2 Ground Plane	44.6	-3.51	2.17				
4G/3G Band 12,13,14,17,28,29	698-824	4G-5G 1 Free Space	39.4	-4.05	2.34				
		4G-5G 1 Ground Plane	53.2	-2.74	2.97				
		4G-5G 2 Free Space	36.0	-4.43	1.67				
		4G-5G 2 Ground Plane	65.1	-1.87	3.95				
4G/3G/NB-IoT/Cat M Band 5,8,18,19,20,26,27	824-960	4G-5G 1 Free Space	42.6	-3.70	3.27				
		4G-5G 1 Ground Plane	47.4	-3.24	4.73				
		4G-5G 2 Free Space	40.1	-3.97	2.69				
		4G-5G 2 Ground Plane	51.3	-2.90	4.00				
5G NR/4G Band 21,32,74,75,76	1427-1518	4G-5G 1 Free Space	24.5	-6.11	0.17				
		4G-5G 1 Ground Plane	16.1	-7.94	0.31				
		4G-5G 2 Free Space	29.9	-5.25	1.66				
		4G-5G 2 Ground Plane	15.7	-8.05	2.98				
4G/3G Band 1,2,3,4,9,23,25,35,39,66	1710-2200	4G-5G 1 Free Space	69.4	-1.59	4.89				
		4G-5G 1 Ground Plane	54.4	-2.65	4.72				
		4G-5G 2 Free Space	69.8	-1.56	3.87				
		4G-5G 2 Ground Plane	54.4	-2.64	5.60				
4G/3G Band 7,30,38,40,41	2300-2690	4G-5G 1 Free Space	64.5	-1.91	3.95				
		4G-5G 1 Ground Plane	67.7	-1.69	5.70				
		4G-5G 2 Free Space	63.1	-2.00	2.87				
		4G-5G 2 Ground Plane	69.5	-1.58	6.01				
5G NR/4G Band 22,42,48,77,78,79	3300-5000	4G-5G 1 Free Space	48.2	-3.17	3.80				
		4G-5G 1 Ground Plane	50.8	-2.94	5.50				
		4G-5G 2 Free Space	52.6	-2.79	4.85				
		4G-5G 2 Ground Plane	52.3	-2.81	5.02				
LTE5200/Wi-Fi5800	5150-5925	4G-5G 1 Free Space	50.6	-2.96	4.85				
		4G-5G 1 Ground Plane	51.7	-2.86	5.92				
		4G-5G 2 Free Space	51.3	-2.90	4.81				
		4G-5G 2 Ground Plane	48.2	-3.17	5.47				

4G-5G Bands

Band Number	5G NR / FR1 / LTE / LTE-Advanced / WCDMA / HSPA / HSPA+ / TD-SCDMA					
	Uplink	Downlink	LTE1 - Free Space	LTE1 - Ground Plane	LTE2 - Free Space	LTE2 - Ground Plane
B1	1920 to 1980	2110 to 2170	✓	✓	✓	✓
B2	1850 to 1910	1930 to 1990	✓	✓	✓	✓
B3	1710 to 1785	1805 to 1880	✓	✓	✓	✓
B4	1710 to 1755	2110 to 2155	✓	✓	✓	✓
B5	824 to 849	869 to 894	✓	✓	✓	✓
B7	2500 to 2570	2620 to 2690	✓	✓	✓	✓
B8	880 to 915	925 to 960	✓	✓	✓	✓
B9*	1749.9 to 1784.9	1844.9 to 1879.9	✓	✓	✓	✓
B11	1427.9 to 1447.9	1475.9 to 1495.9	✓	✗	✗	✗
B12	699 to 716	729 to 746	✓	✓	✓	✓
B13	777 to 787	746 to 756	✓	✓	✓	✓
B14	788 to 798	758 to 768	✓	✓	✓	✓
B17	704 to 716	734 to 746	✓	✓	✓	✓
B18	815 to 830	860 to 875	✓	✓	✓	✓
B19	830 to 845	875 to 890	✓	✓	✓	✓
B20	832 to 862	791 to 821	✓	✓	✓	✓
B21	1447.9 to 1462.9	1495.9 to 1510.9	✓	✗	✓	✗
B22*	3410 to 3490	3510 to 3590	✓	✓	✓	✓
B23*	2000 to 2020	2180 to 2200	✓	✓	✓	✓
B24	1626.5 to 1660.5	1525 to 1559	✓	✓	✓	✓
B25	1850 to 1915	1930 to 1995	✓	✓	✓	✓
B26	814 to 849	859 to 894	✓	✓	✓	✓
B27*	807 to 824	852 to 869	✓	✓	✓	✓
B28	703 to 748	758 to 803	✓	✓	✓	✓
B29		717 to 728	✓	✓	✓	✓
B30	2305 to 2315	2350 to 2360	✓	✓	✓	✓
B31	452.5 to 457.5	462.5 to 467.5	✗	✗	✗	✗
B32		1452 to 1496	✓	✗	✓	✗
B34		2010 to 2025	✓	✓	✓	✓
B35		1850 to 1910	✓	✓	✓	✓
B36		1930 to 1990	✓	✓	✓	✓
B37		1910 to 1930	✓	✓	✓	✓
B38		2570 to 2620	✓	✓	✓	✓
B39		1880 to 1920	✓	✓	✓	✓
B40		2300 to 2400	✓	✓	✓	✓
B41		2496 to 2690	✓	✓	✓	✓
B42		3400 to 3600	✓	✓	✓	✓
B43		3600 to 3800	✓	✓	✓	✓
B45		1447 to 1467	✓	✗	✓	✗
B46		5150 to 5925	✓	✓	✓	✓
B47		5855 to 5925	✓	✓	✓	✓
B48		3550 to 3700	✓	✓	✓	✓
B49		3550 to 3700	✓	✓	✓	✓
B50		1432 to 1517	✓	✗	✓	✗
B51		1427 to 1432	✗	✗	✗	✗
B52		3300 to 3400	✓	✓	✓	✓
B53		2483.5 to 2495	✓	✓	✓	✓
B65	1920 to 2010	2110 to 2200	✓	✓	✓	✓
B66	1710 to 1780	2110 to 2200	✓	✓	✓	✓
B68	698 to 728	753 to 783	✓	✓	✓	✓
B69		2570 to 2620	✓	✓	✓	✓
B70	1695 to 1710	1995 to 2020	✓	✓	✓	✓
B71	663 to 698	617 to 652	✓	✓	✓	✓
B72	451 to 456	461 to 466	✗	✗	✗	✗
B73	450 to 455	460 to 465	✗	✗	✗	✗
B74	1427 to 1470	1475 to 1518	✓	✗	✓	✗
B75		1432 to 1517	✓	✗	✓	✗
B76		1427 to 1432	✗	✗	✗	✗
B77		3300 to 4200	✓	✓	✓	✓
B78		3300 to 3800	✓	✓	✓	✓
B79		4400 to 5000	✓	✓	✓	✓
B85	698 to 716	728 to 746	✓	✓	✓	✓
B87	410 to 415	420 to 425	✗	✗	✗	✗
B88	412 to 417	422 to 427	✗	✗	✗	✗

Mechanical

Dimensions	Ø59.45 x 70mm
Material	ASA (Anti UV rated)
Connector	SMA(M)
Cable	GNSS – RG-174 Cellular – TGC-1.5DS

Environmental

Operation Temperature	-40°C to 85°C
Storage Temperature	-40°C to 85°C
Relative Humidity	Non-condensing 65°C 95% RH
Ingress Protection	IP67

3. Mechanical Drawing

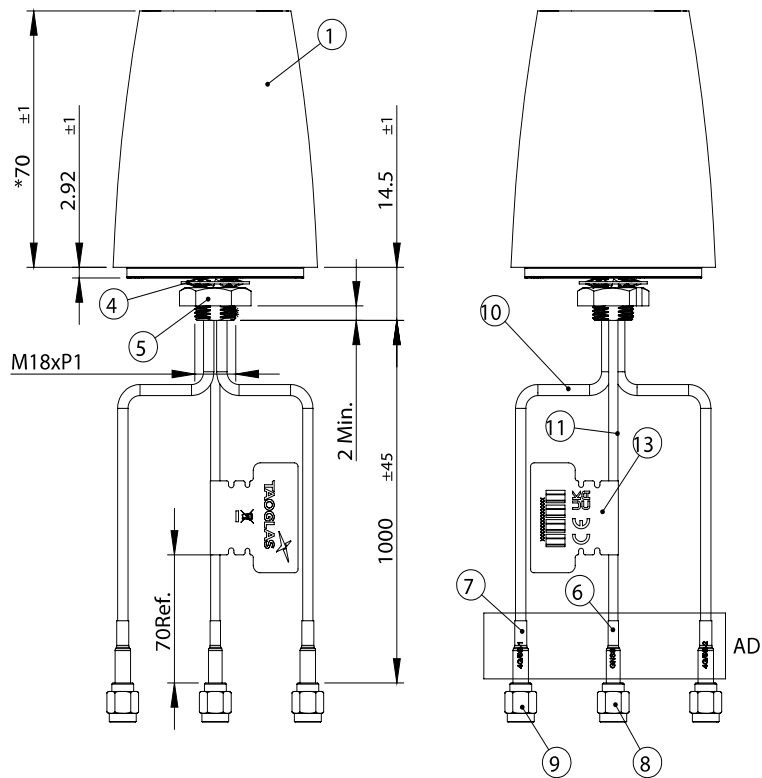
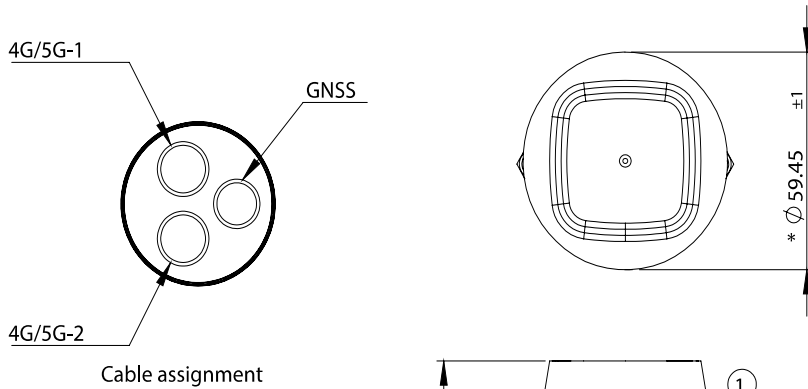

	Name	Material	Finish	Qty
1	Top housing	ASA	White, MT9050	1
2	Bottom housing	ASA	Black	1
3	Grommet	Silicone Rubber	Black	1
4	Multi Tooth Washer	Iron	Ni Plated	1
5	Nut M12_Cut	Brass	Ni Plated	1
6	Heat Shrink Tube(GNSS)	PE	Blue Tube/White Text	1
7	Heat Shrink Tube(4G/5G-1)	PE	Red Tube/White Text	1
8	SMA(M)ST Plug	Brass	Au Plated	1
9	SMA(M)ST Plug for low loss1.5DS	Brass	Au Plated	2
10	TGC-1.5DS Coaxial Cable	XLPE	Black	1
11	RG174 Coaxial Cable	PVC	Black	1
12	Double Sided Adhesive	E4308+3M 9448HK	Black foam/white liner	1
13	CE, WEEE and UKCA mark logo Label	PEPA	White	1
14	Heat Shrink Tube(4G/5G-2)	PE	Red Tube/White Text	1

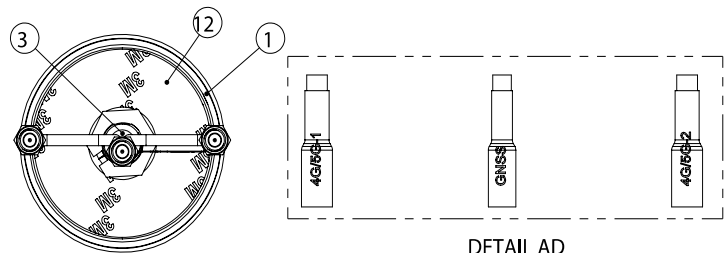

DETAIL AD
SCALE 1 : 1

4. Packaging

1pc MA181 per PE Bag
Weight: 130g

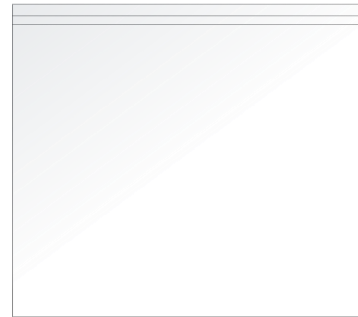

60pcs MA181 per Carton
Carton Dimensions: 430x380x280mm
Weight: 8.9Kg

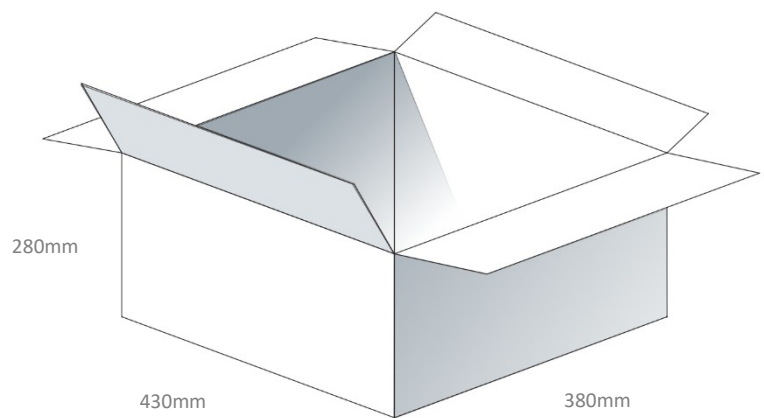

5. Antenna Characteristics

5.1 Test Setup

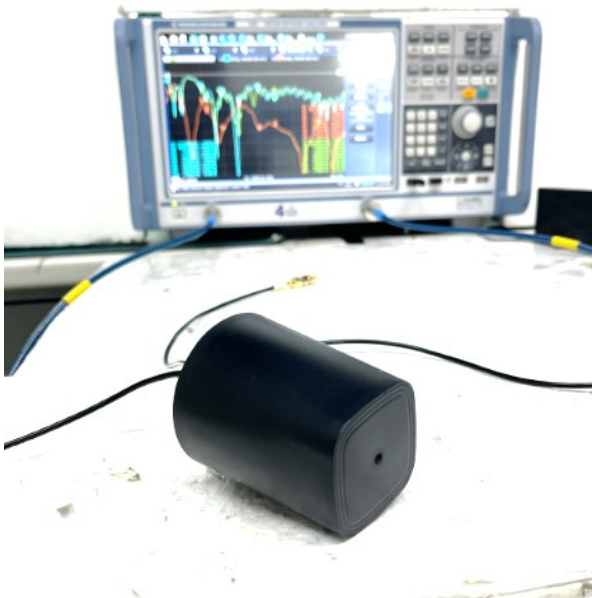
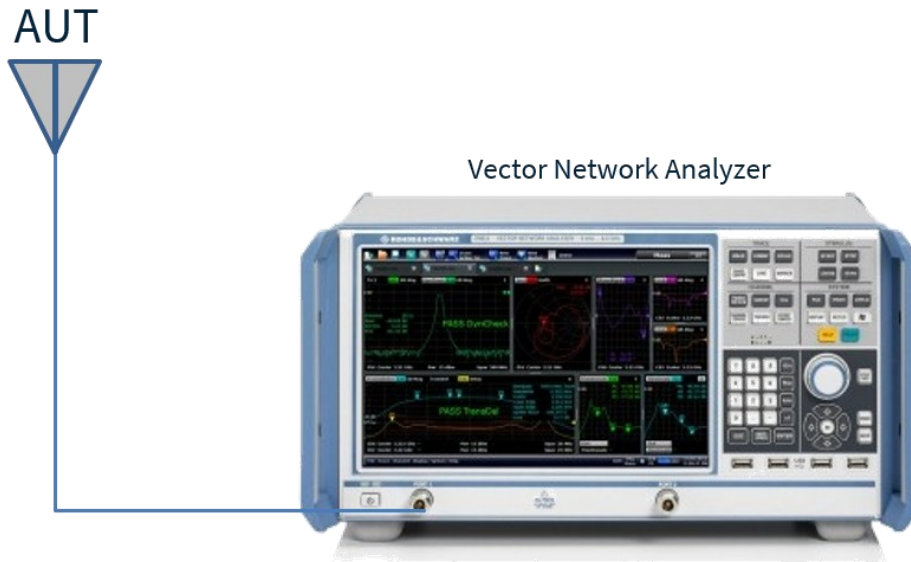

VNA Setup in Free Space

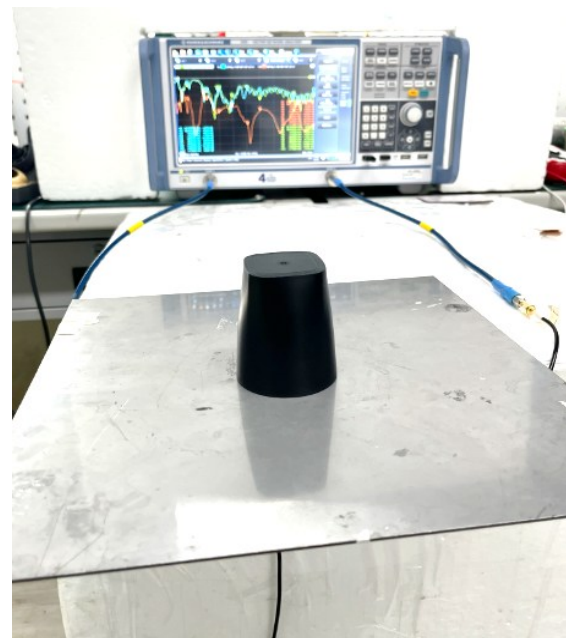

VNA Setup on 30x30cm Ground Plane

5.2 GNSS - Return Loss

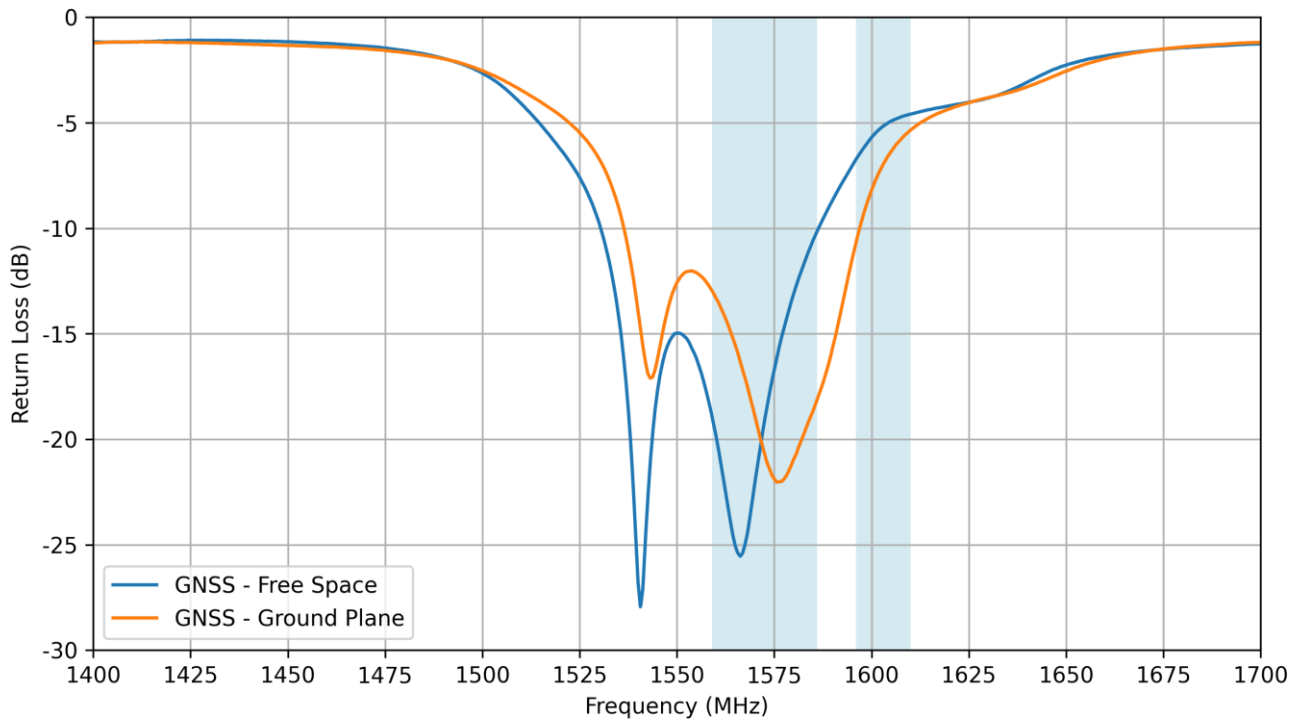

5.3 GNSS - VSWR

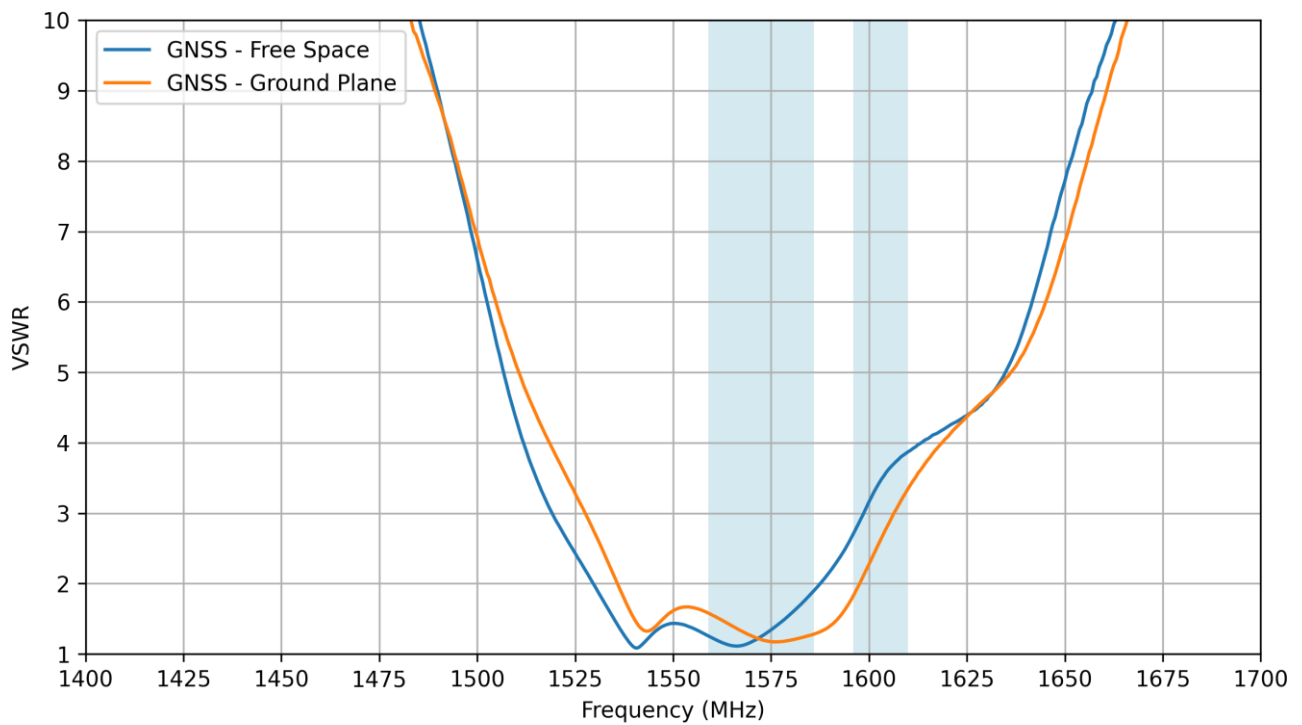

5.4 GNSS - Efficiency

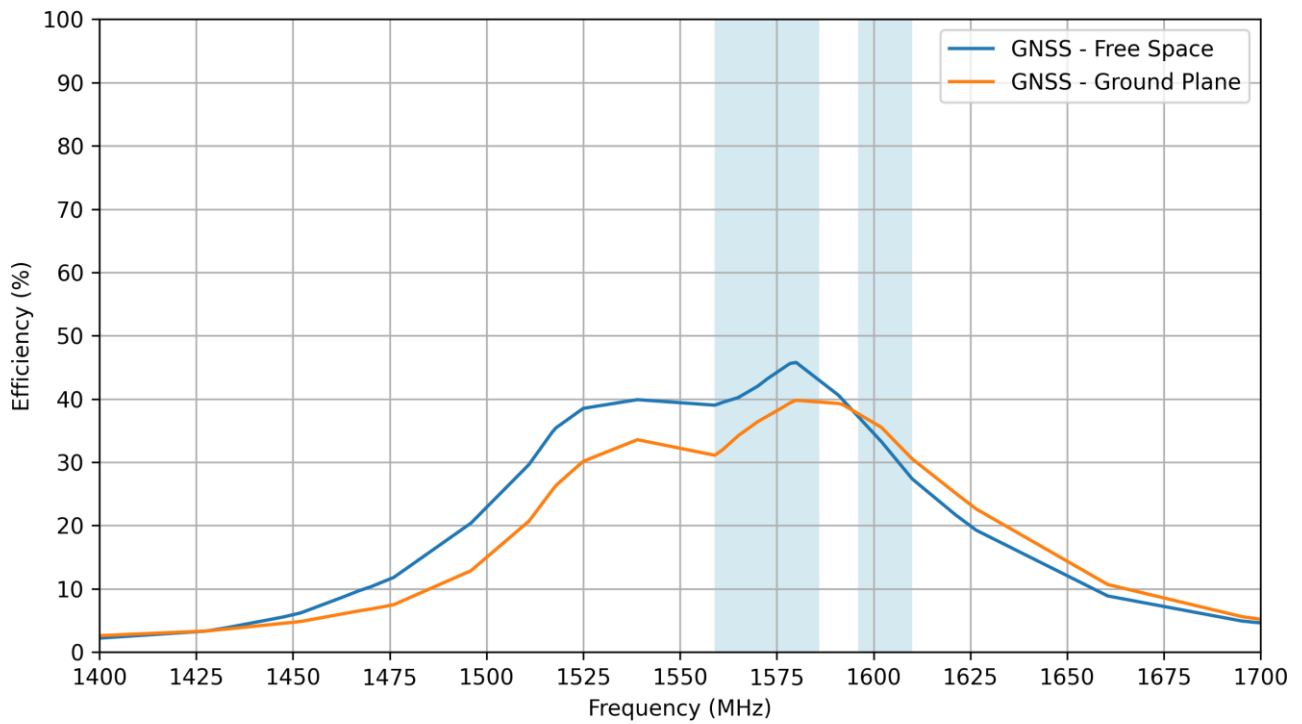

5.5 GNSS - Average Gain

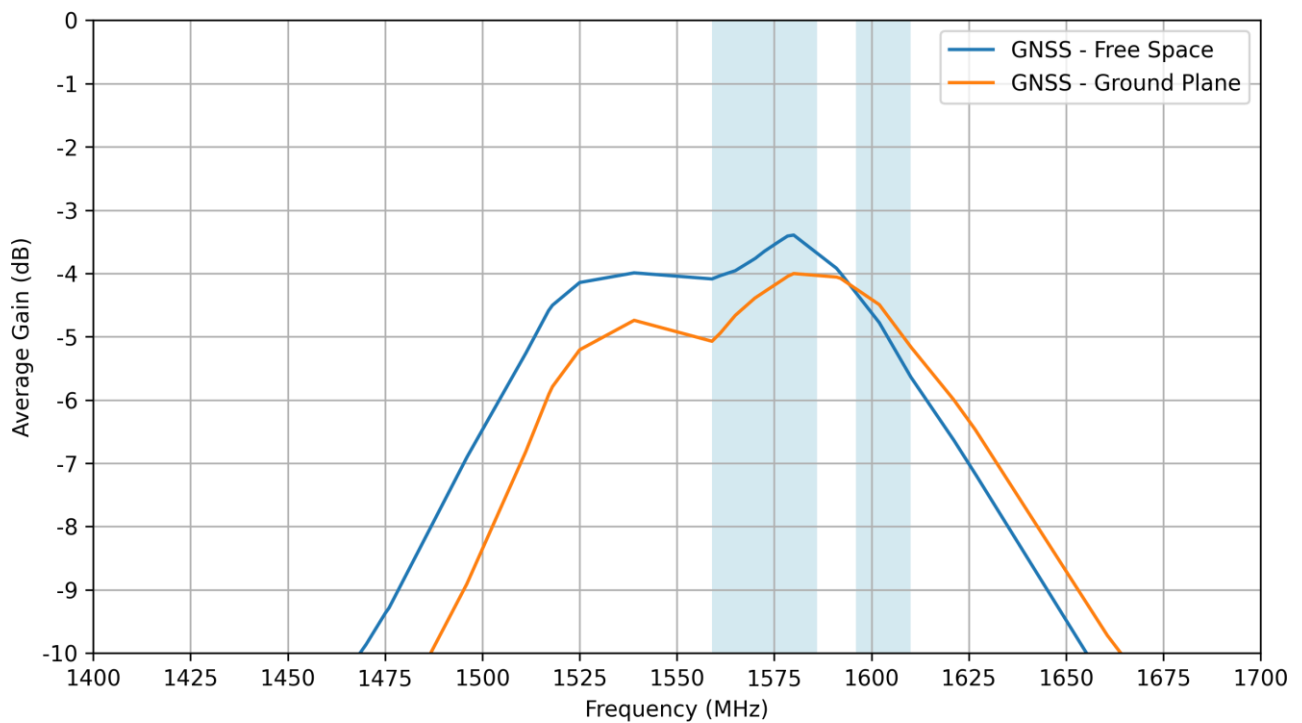

5.6 GNSS - Peak Gain

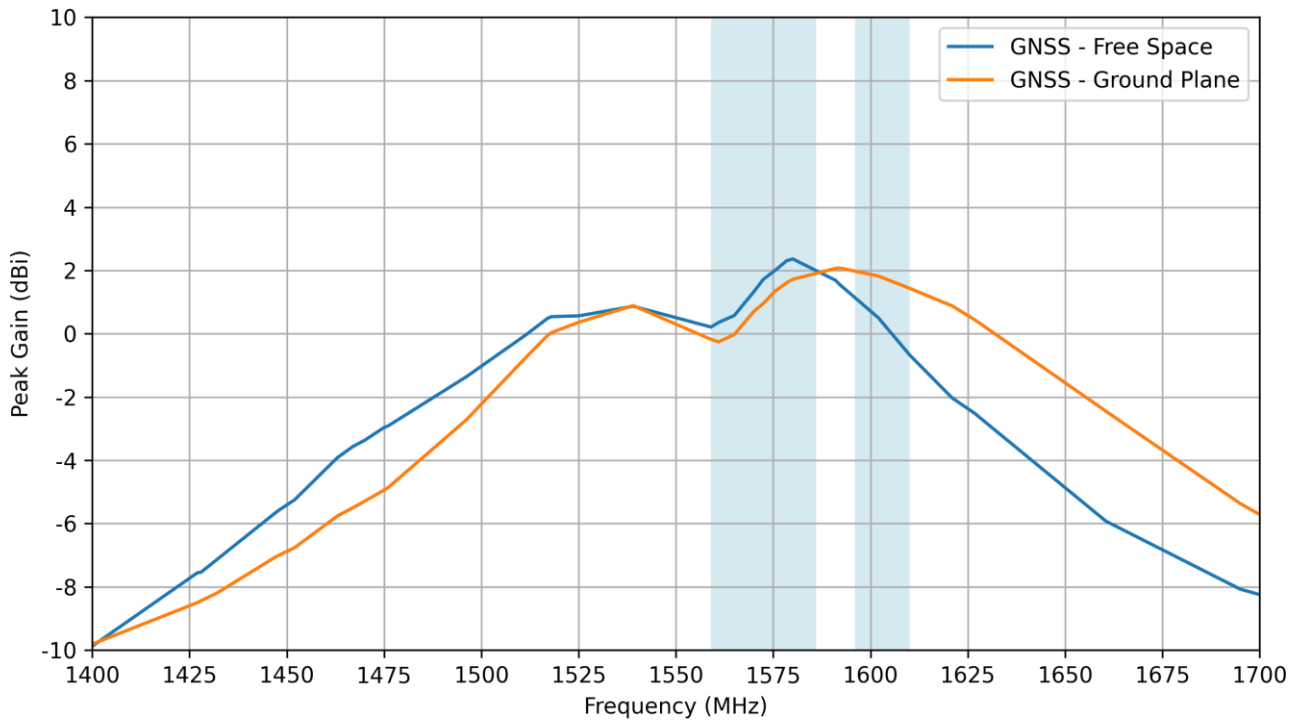

5.7 4G-5G - Return Loss

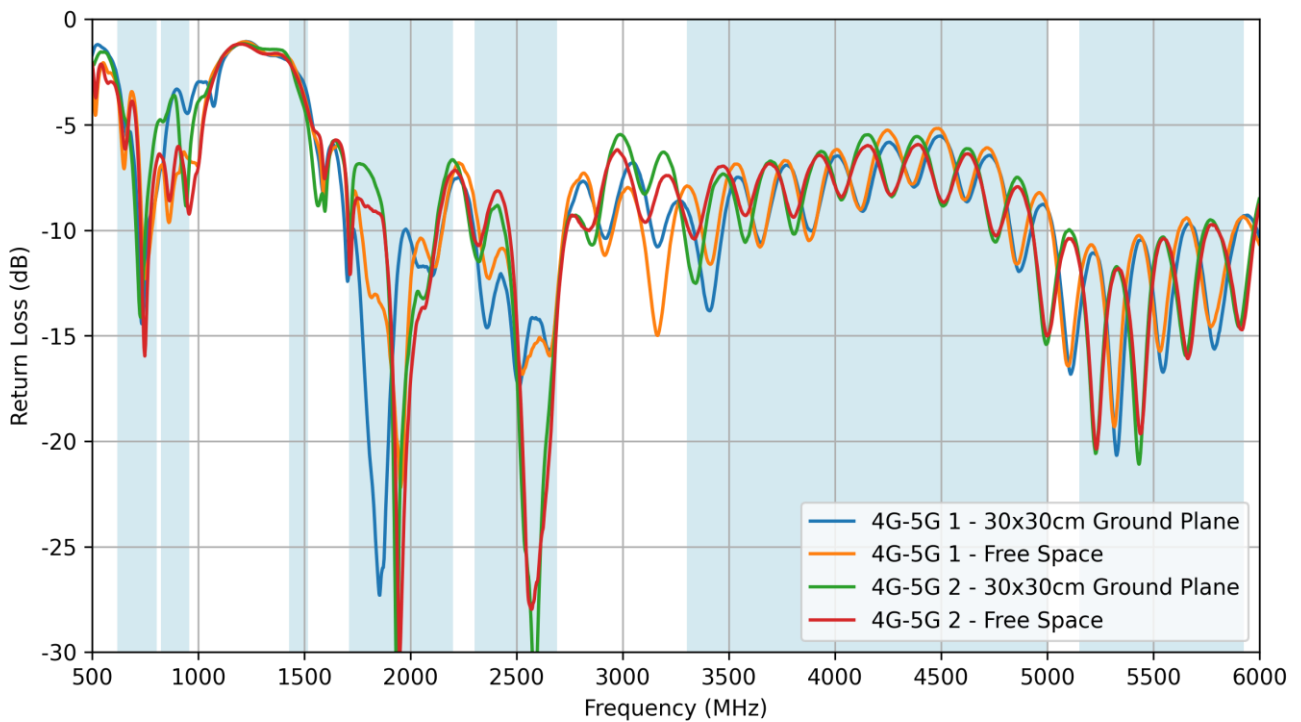

5.8 4G-5G - VSWR

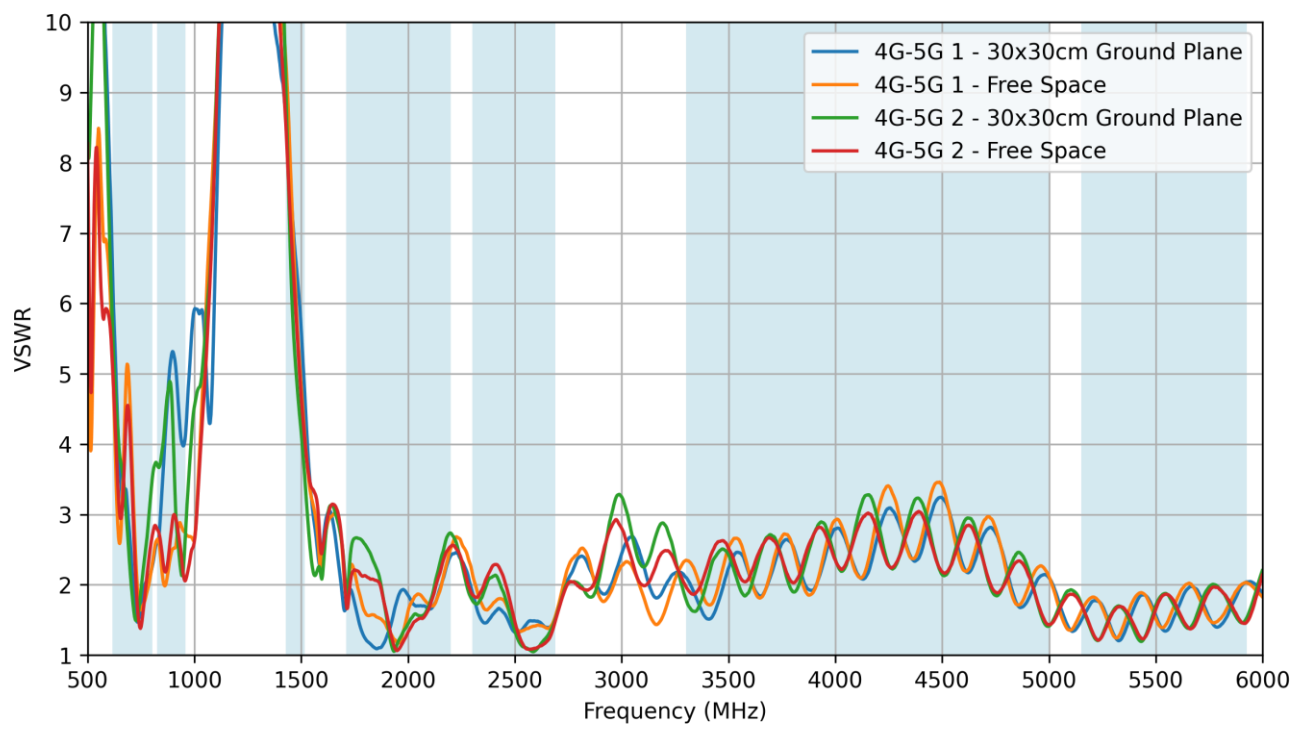

5.9 4G-5G - Efficiency

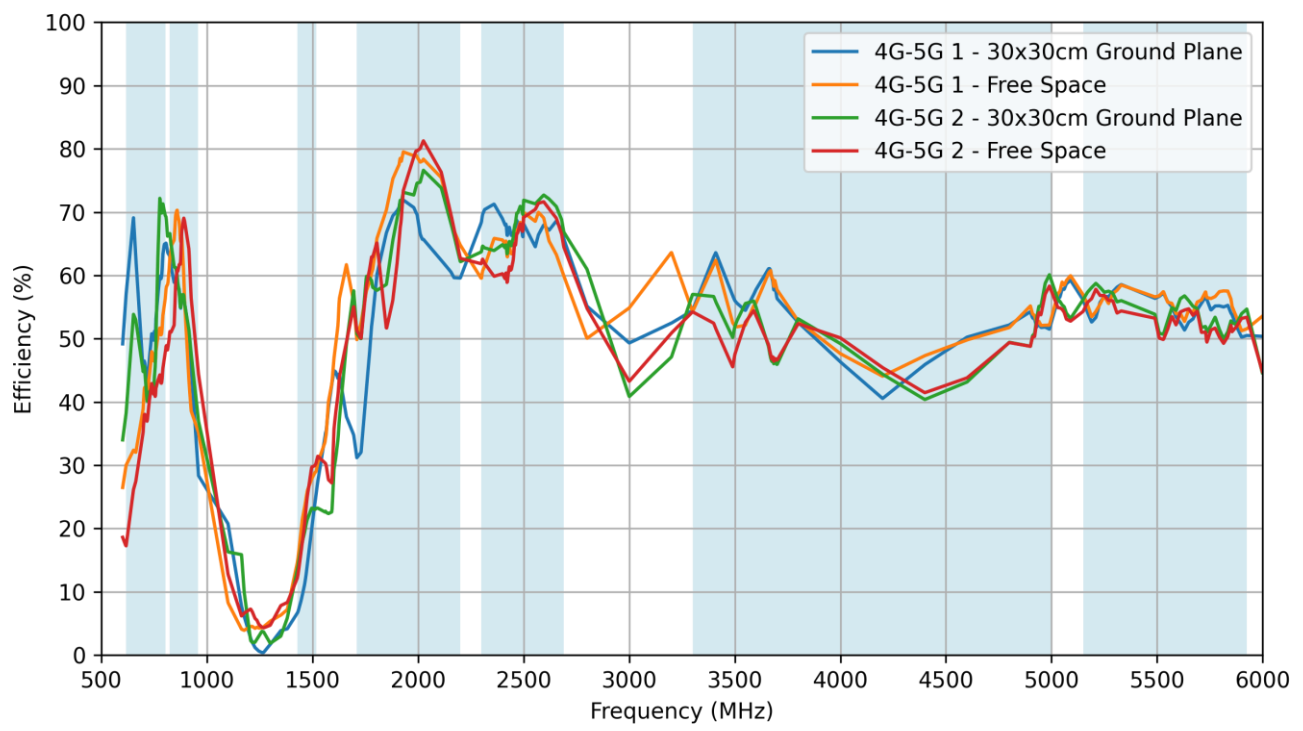

5.10 4G-5G - Average Gain

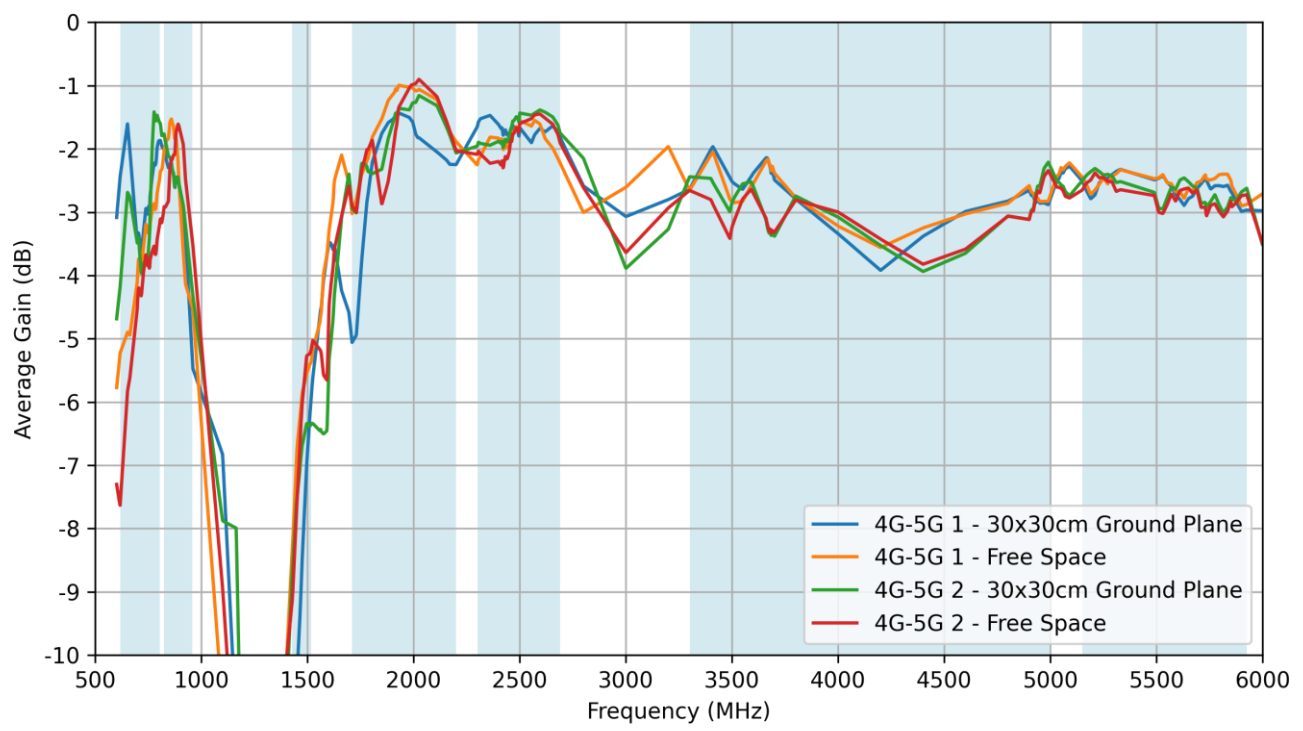

5.11 4G-5G - Peak Gain

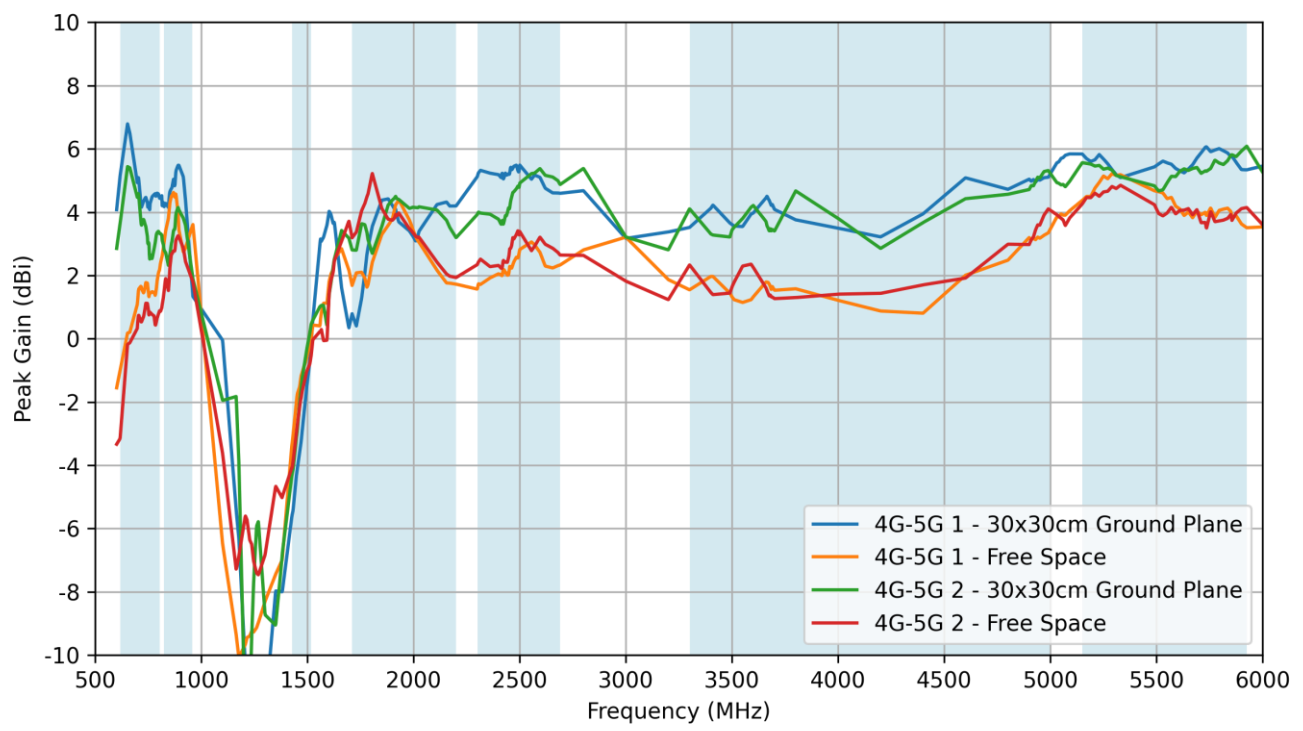

6. Radiation Patterns

6.1 Test Setup

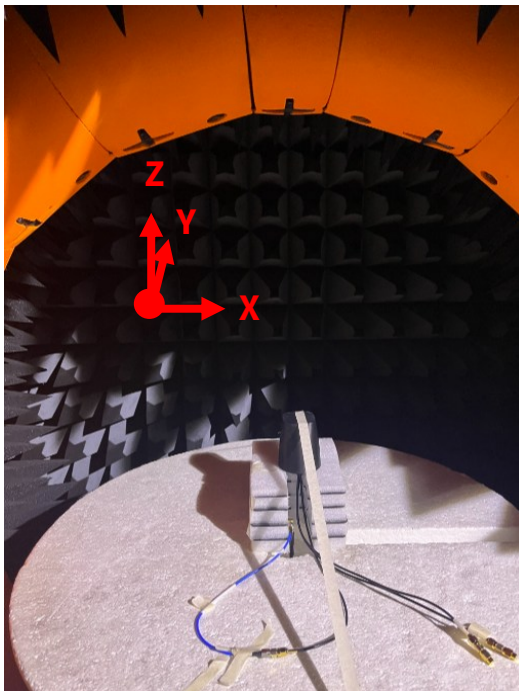
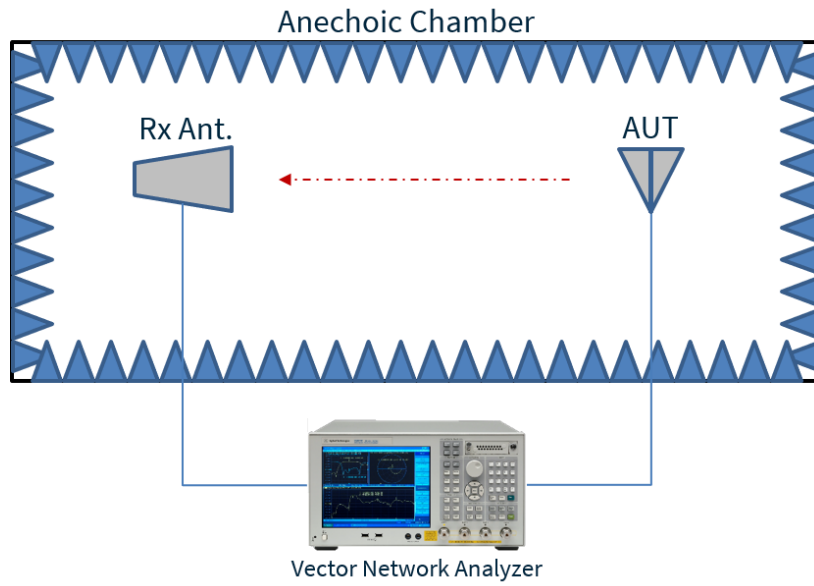

Chamber Setup in Free Space

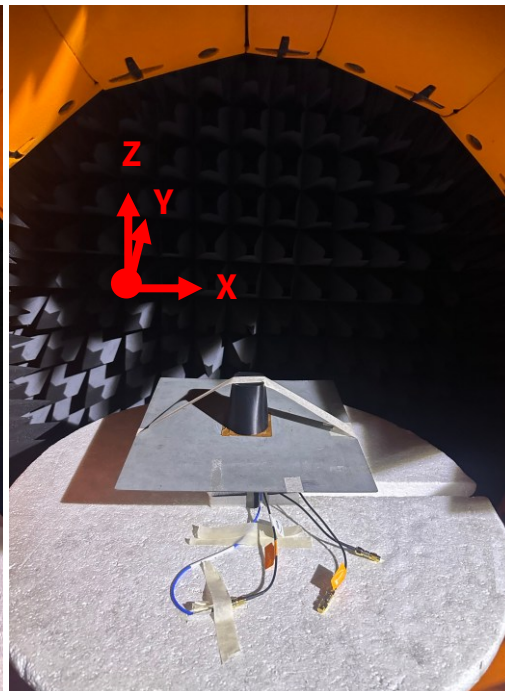

Chamber Setup on 30x30cm Ground Plane

6.2 GNSS - Free Space Patterns at 1575 MHz

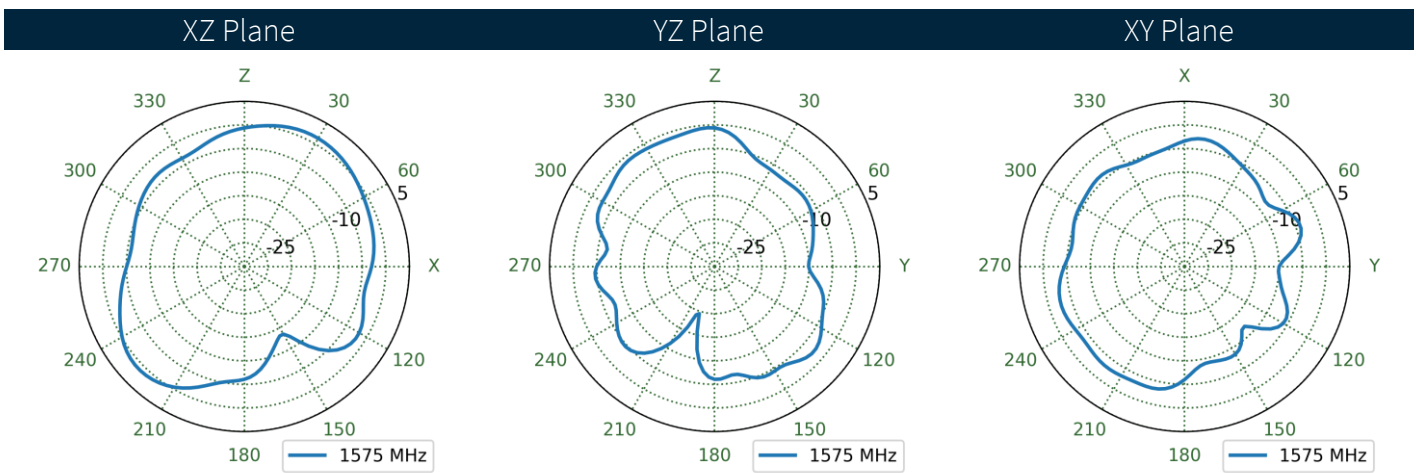
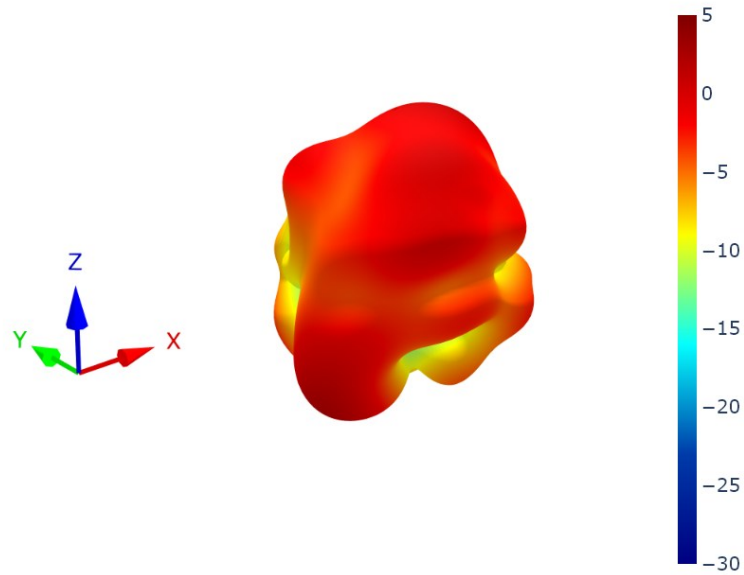

6.3 GNSS - Ground Plane Patterns at 1575 MHz

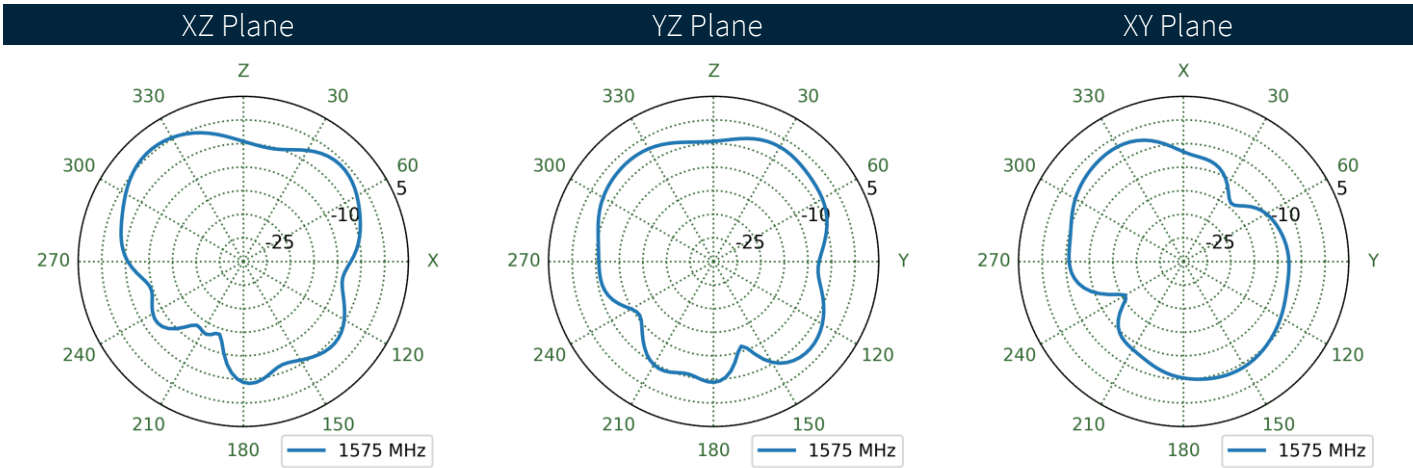
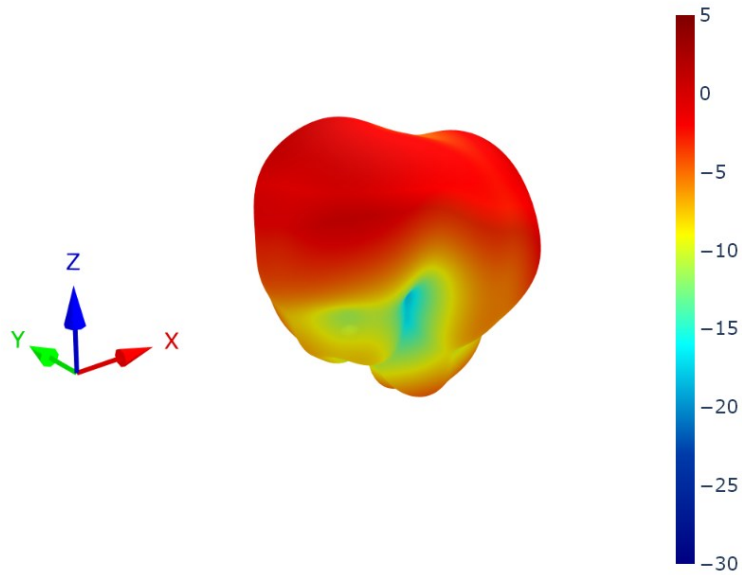

6.4 GNSS - Free Space Patterns at 1561 MHz

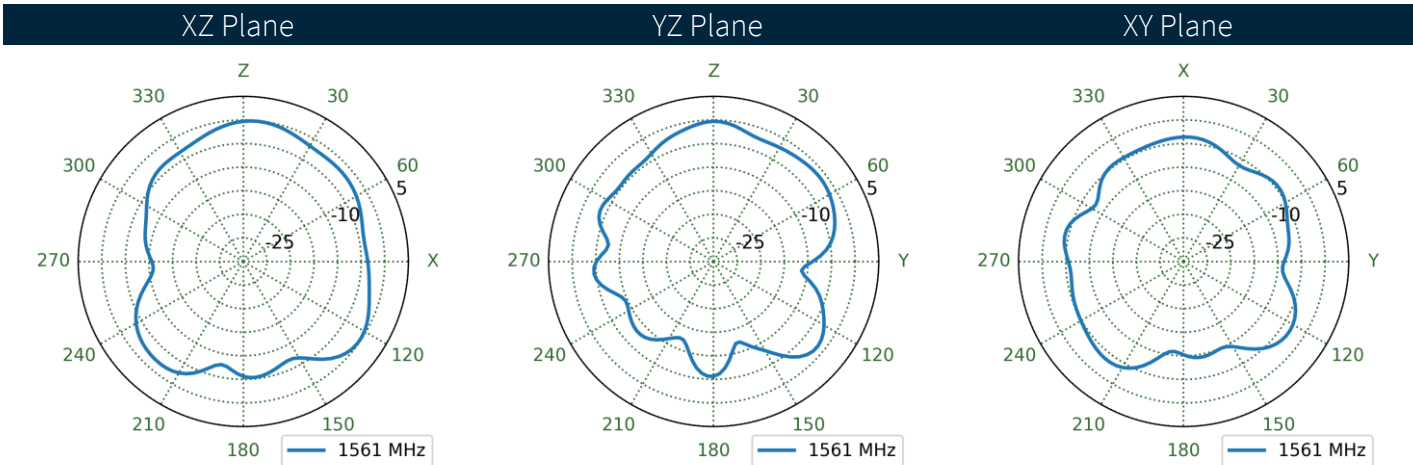
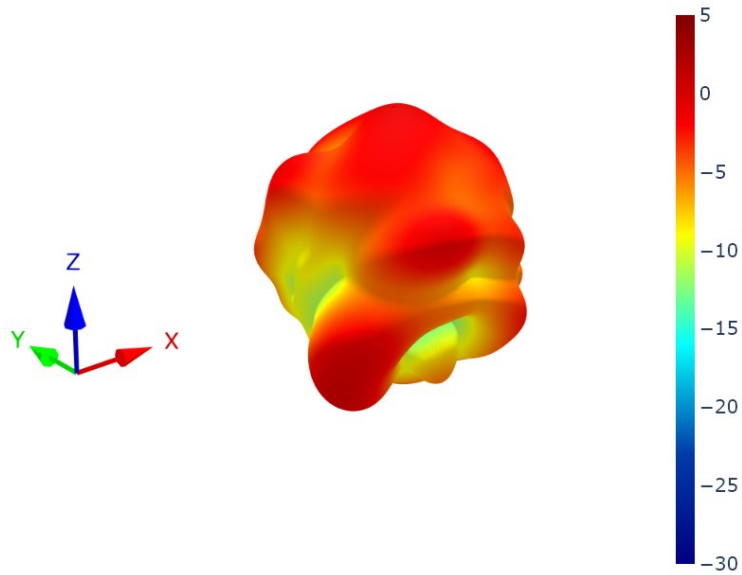

6.5 GNSS - Ground Plane Patterns at 1561 MHz

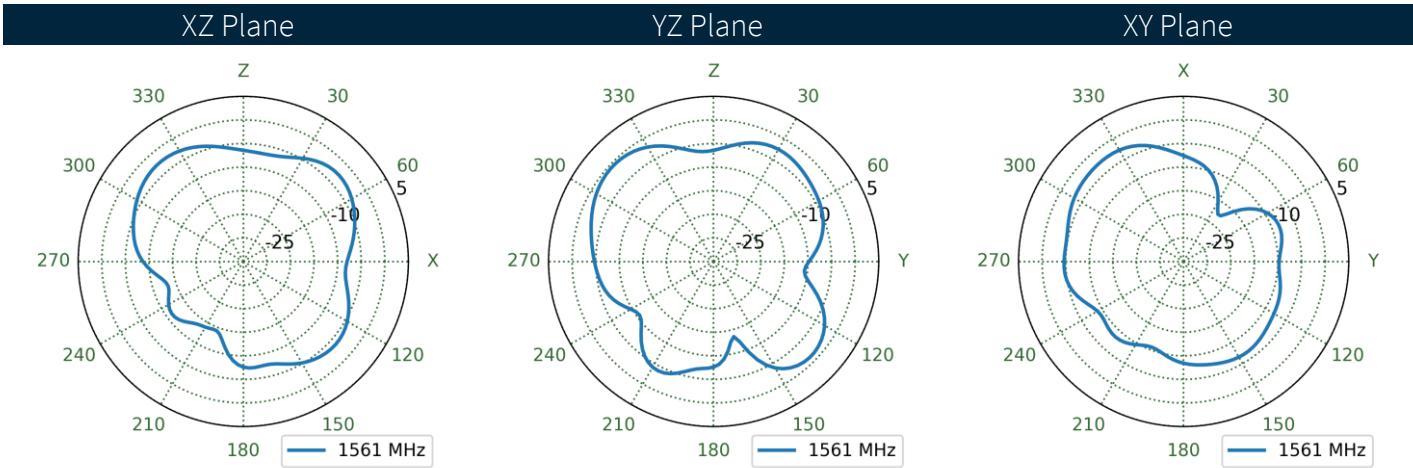
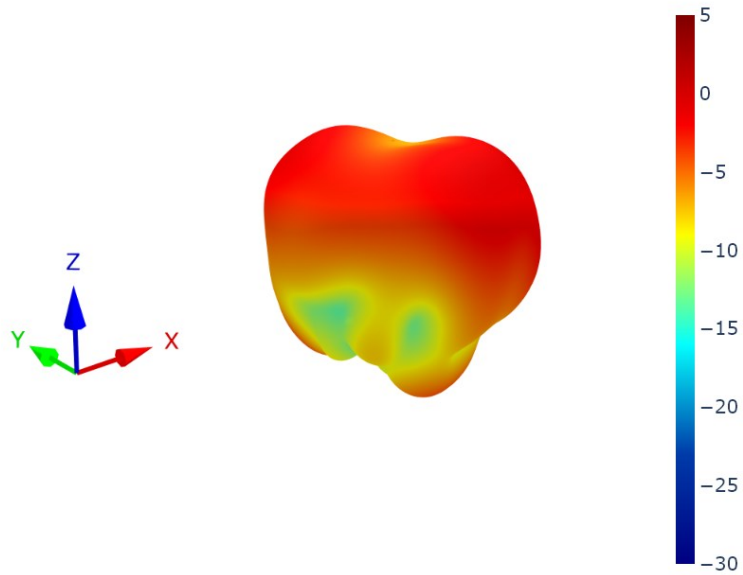

6.6 GNSS - Free Space Patterns at 1602 MHz

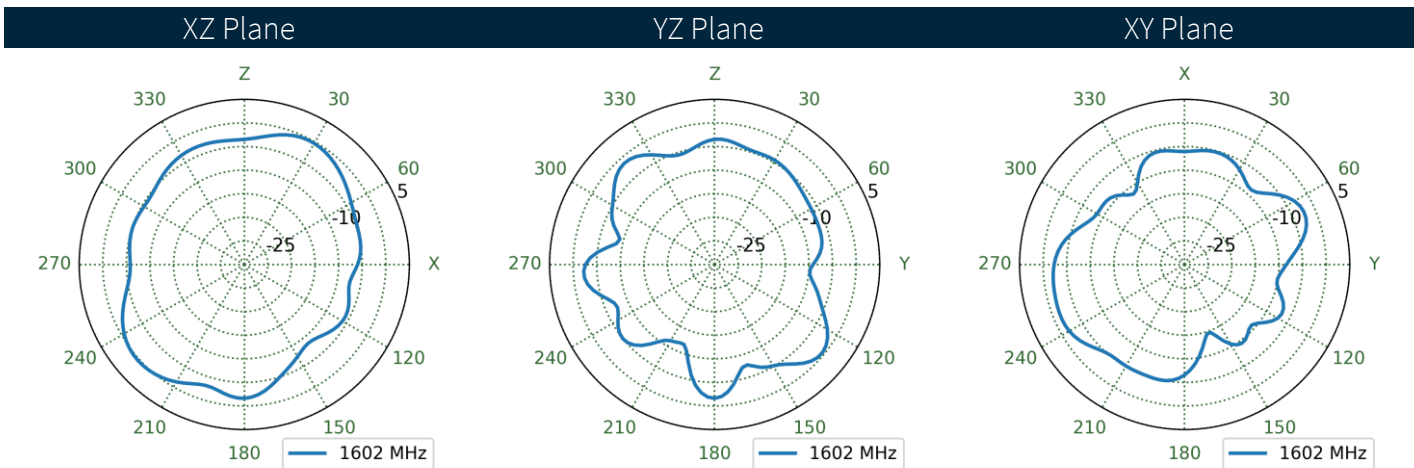
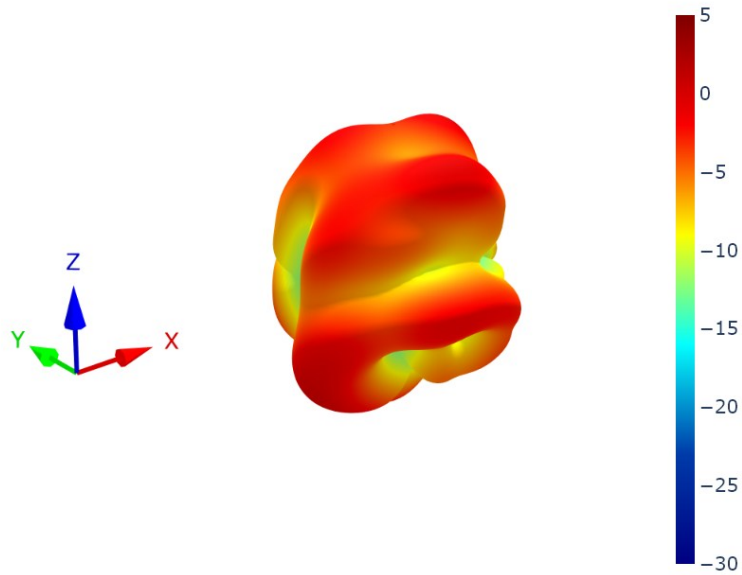

6.7 GNSS - Ground Plane Patterns at 1602 MHz

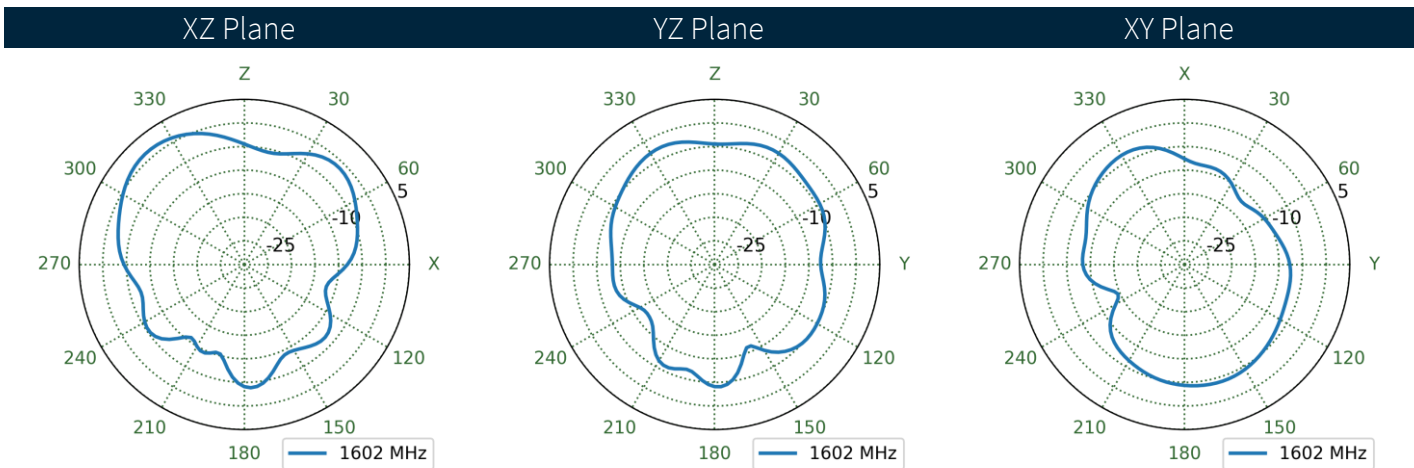
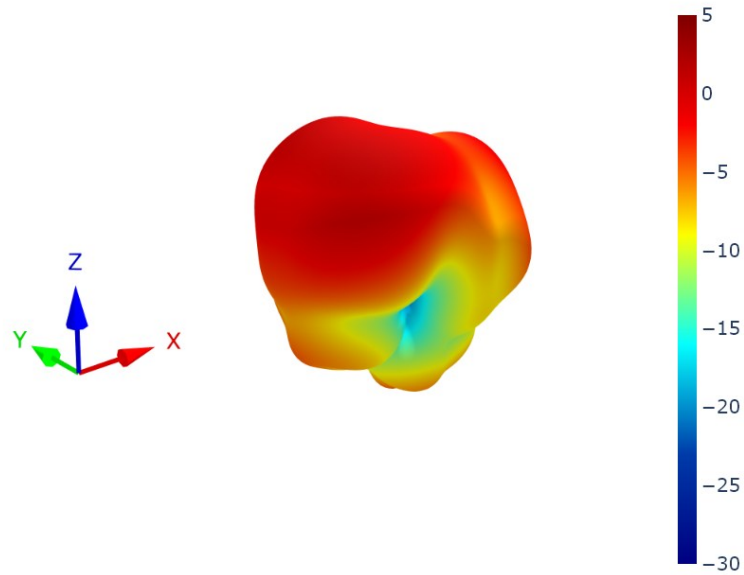

6.8 4G-5G 1 - Free Space Patterns at 652 MHz

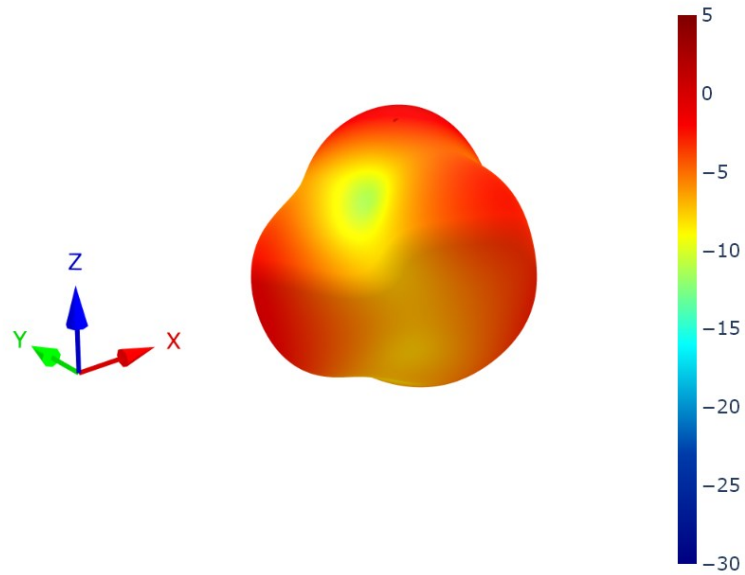

XZ Plane YZ Plane XY Plane

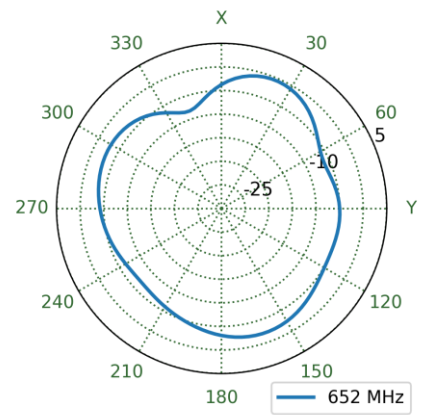
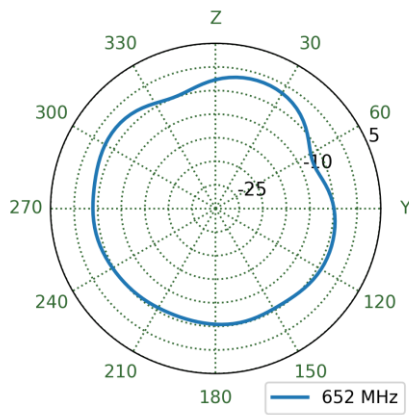
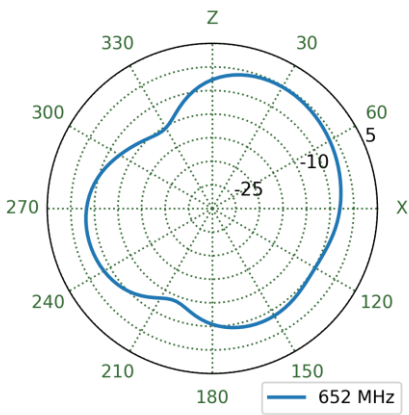

6.9 4G-5G 1 - Ground Plane Patterns at 652 MHz

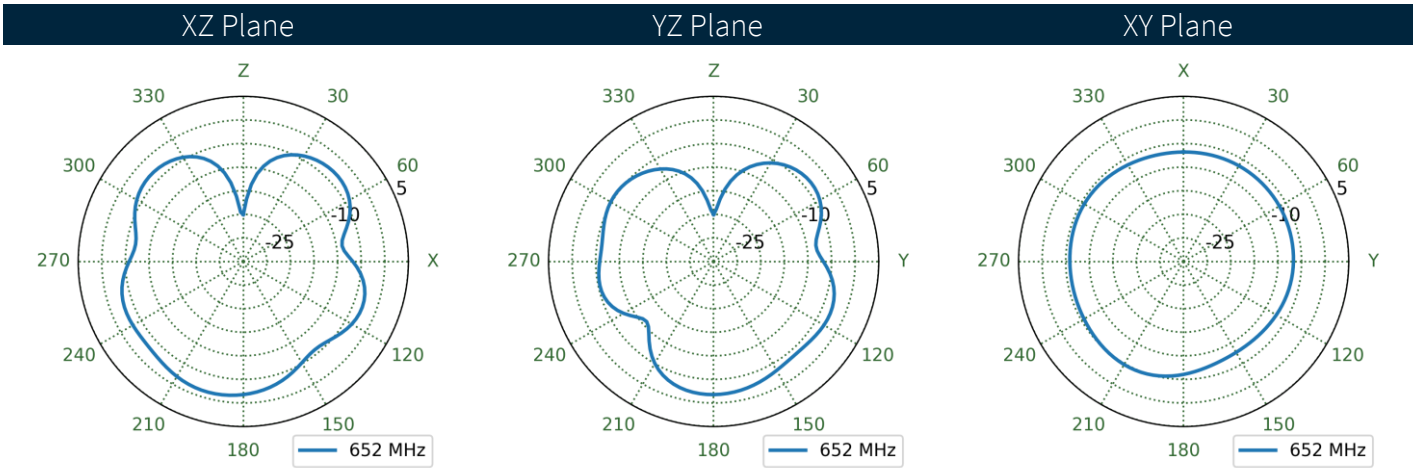
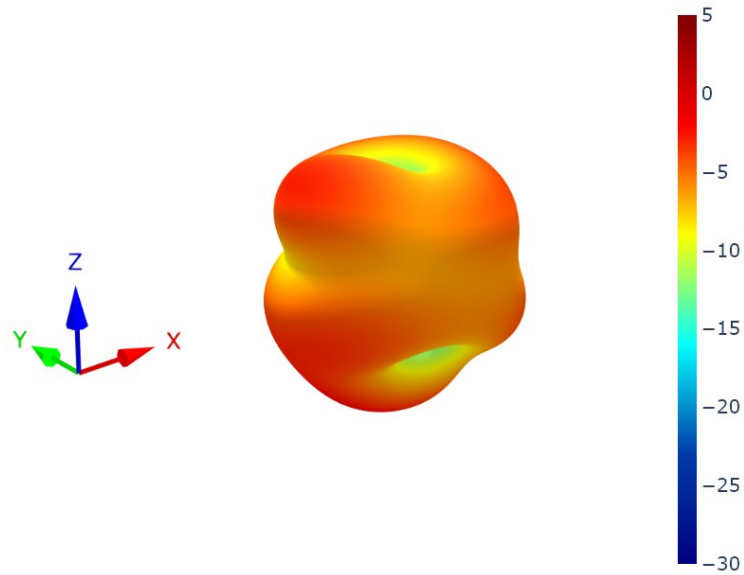

6.10 4G-5G 2 - Free Space Patterns at 652 MHz

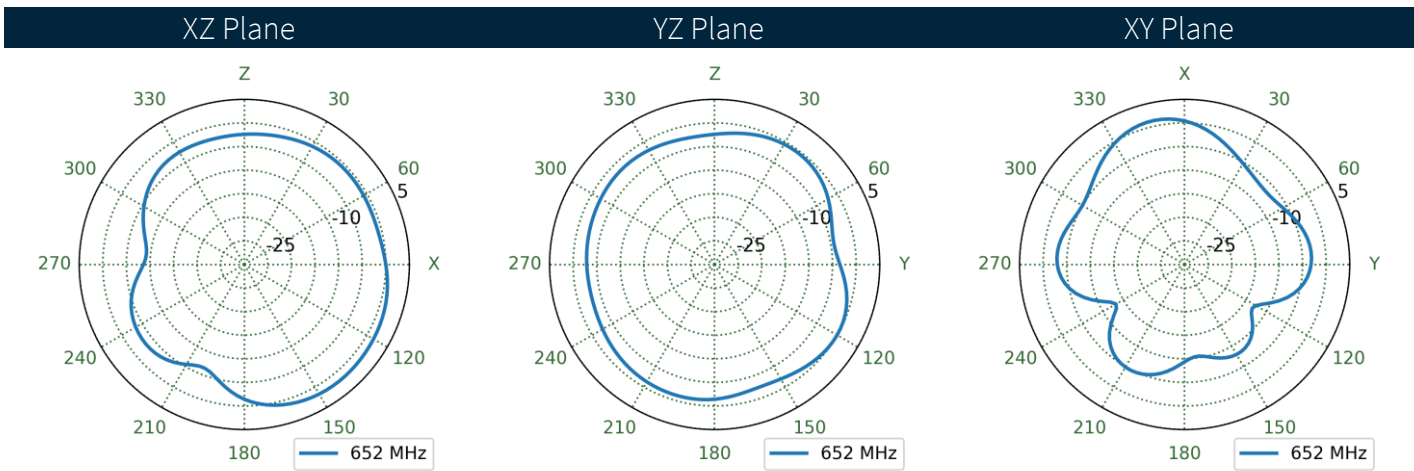
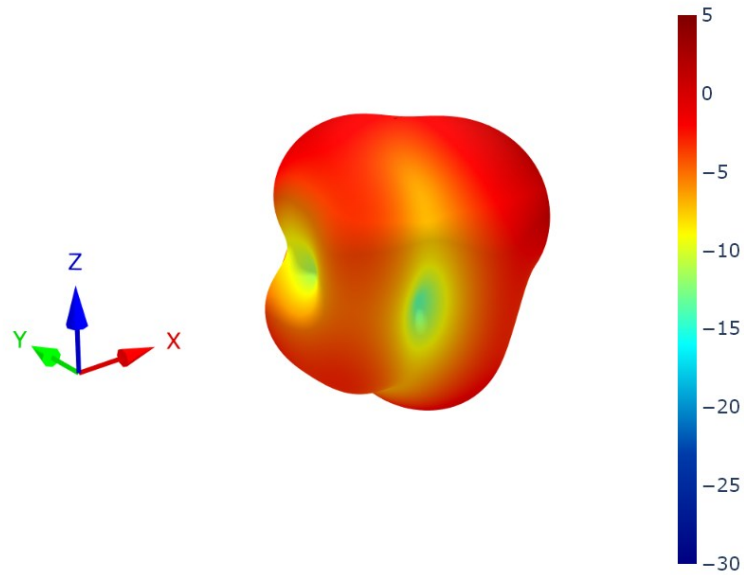

6.11 4G-5G 2 - Ground Plane Patterns at 652 MHz

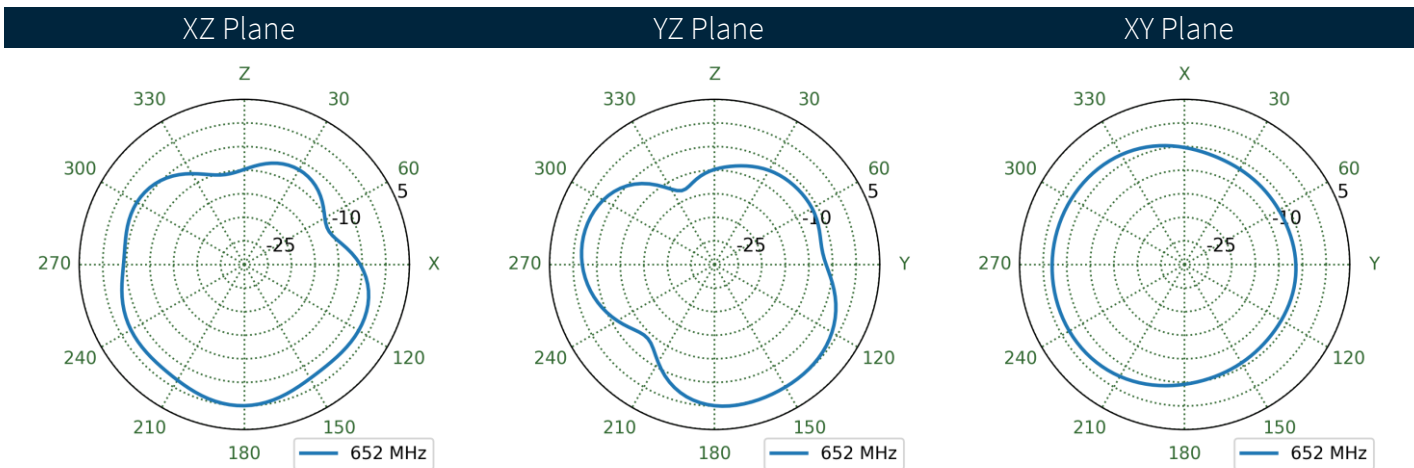
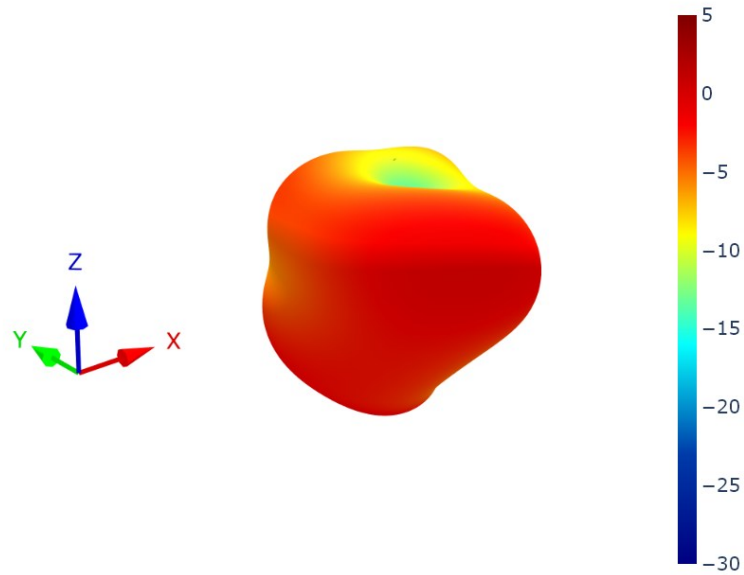

6.12 4G-5G 1 - Free Space Patterns at 758 MHz

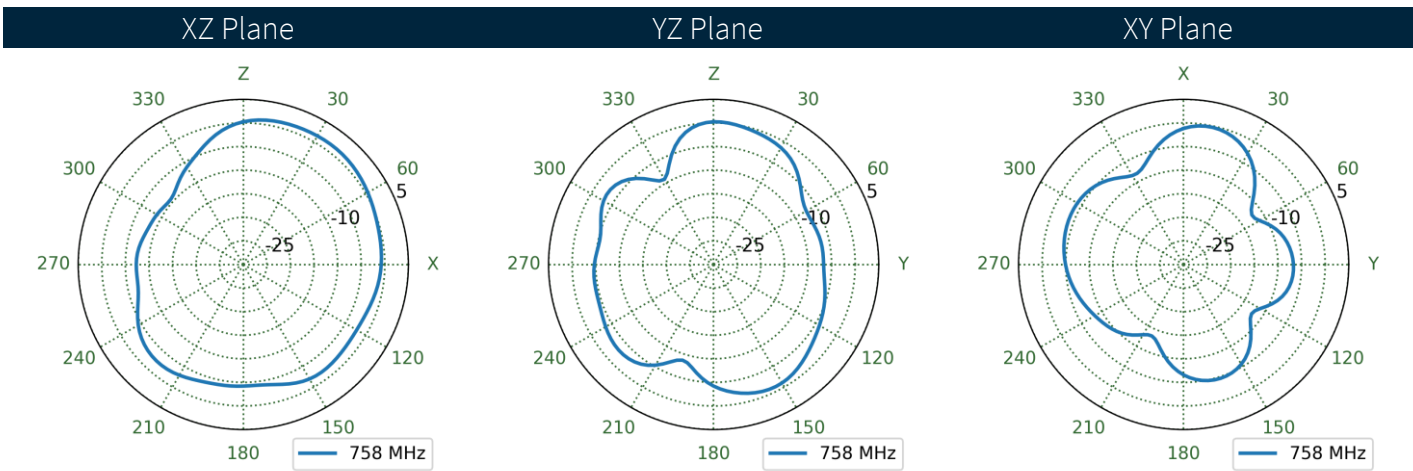
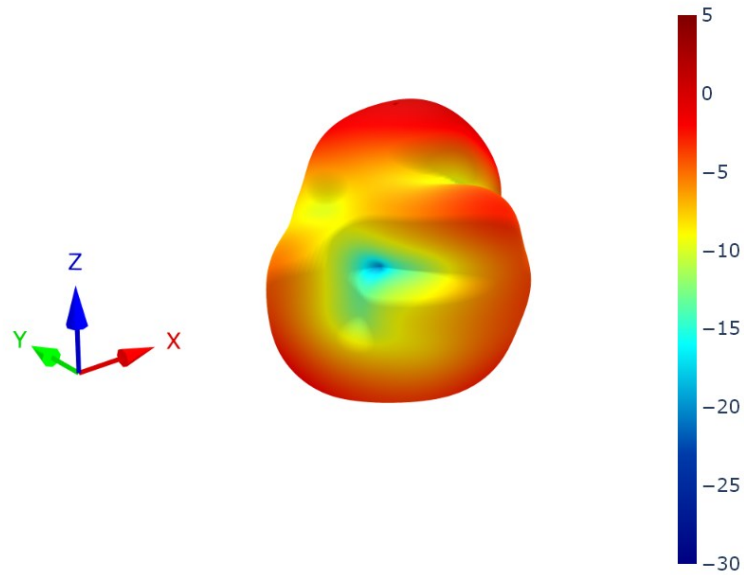

6.13 4G-5G 1 - Ground Plane Patterns at 758 MHz

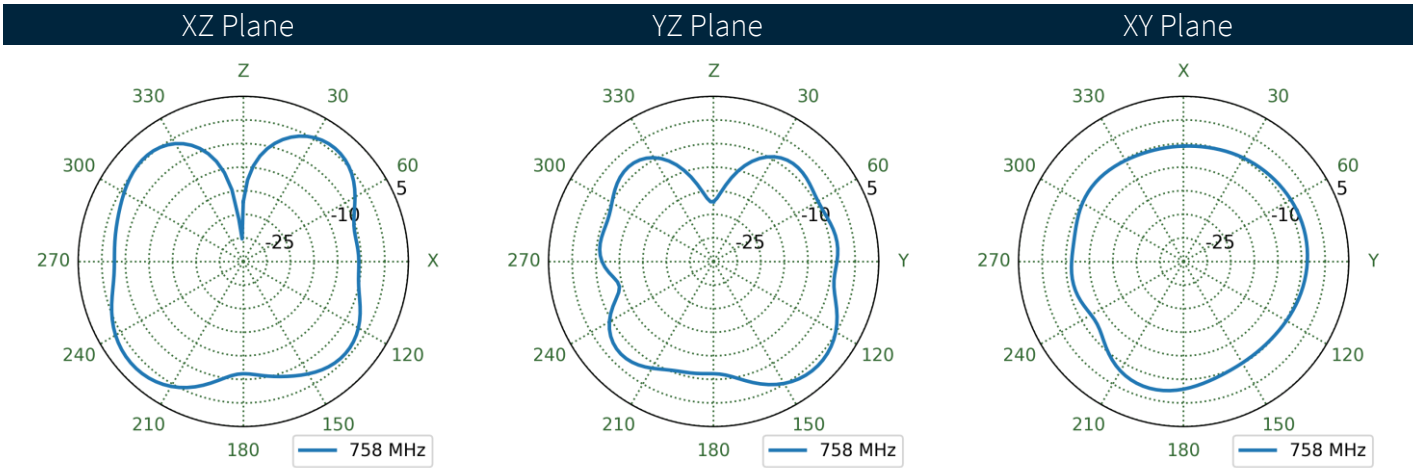
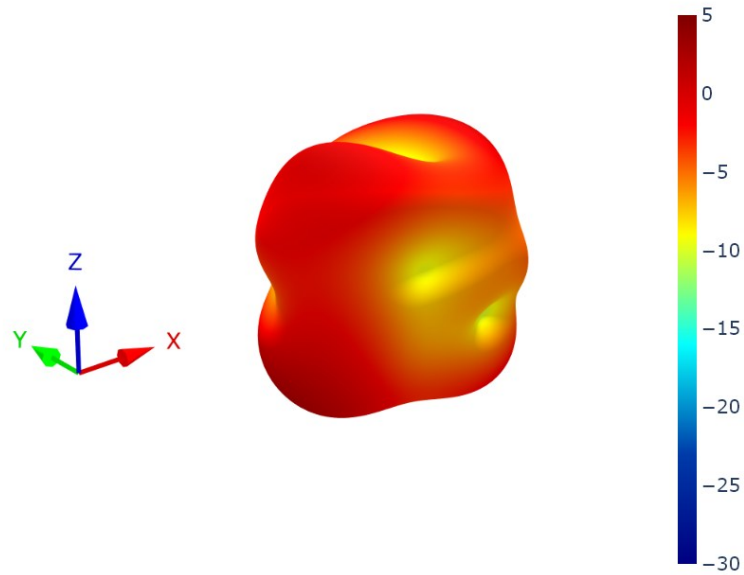

6.14 4G-5G 2 - Free Space Patterns at 758 MHz

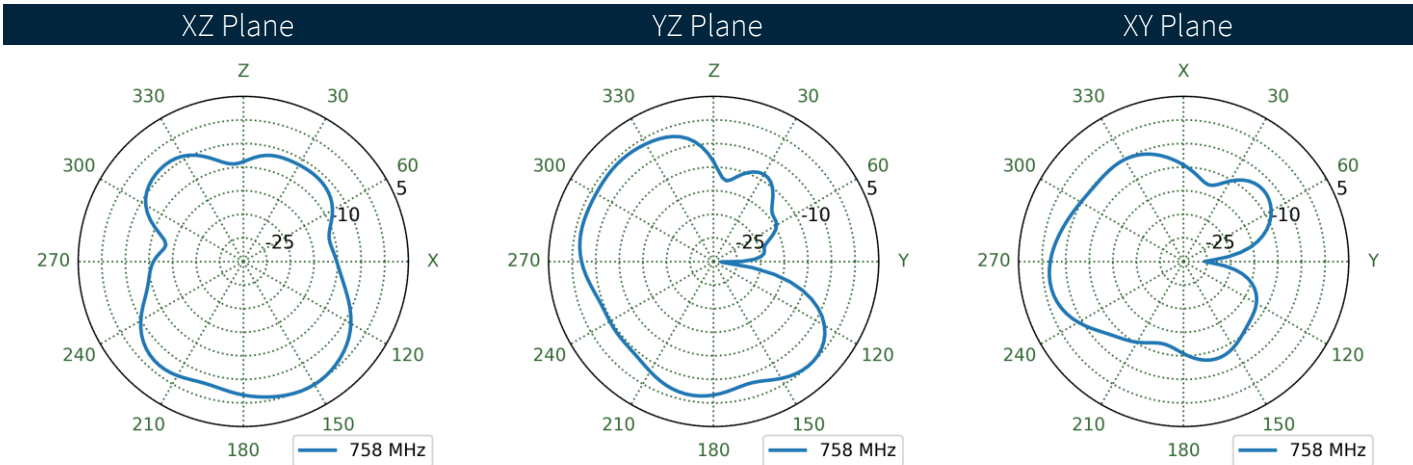
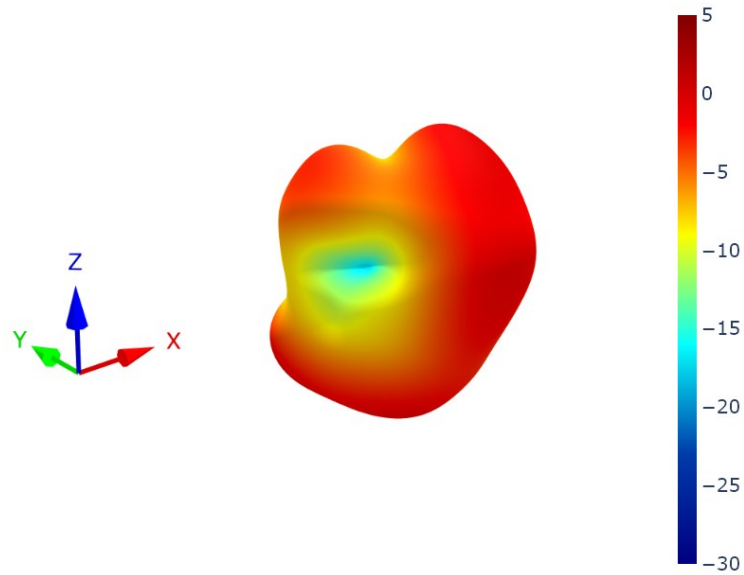

6.15 4G-5G 2 - Ground Plane Patterns at 758 MHz

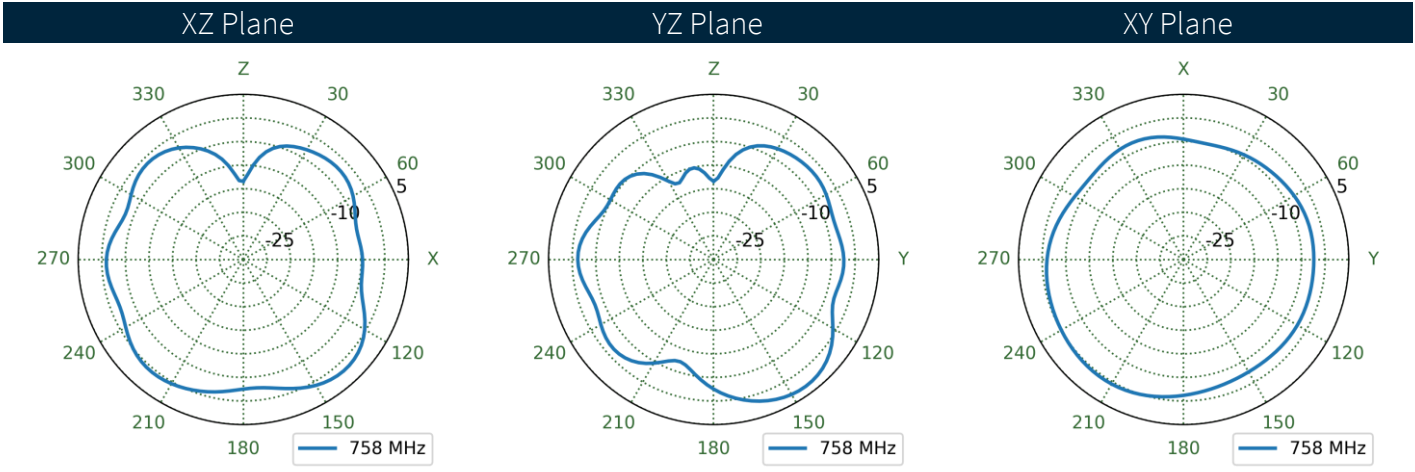
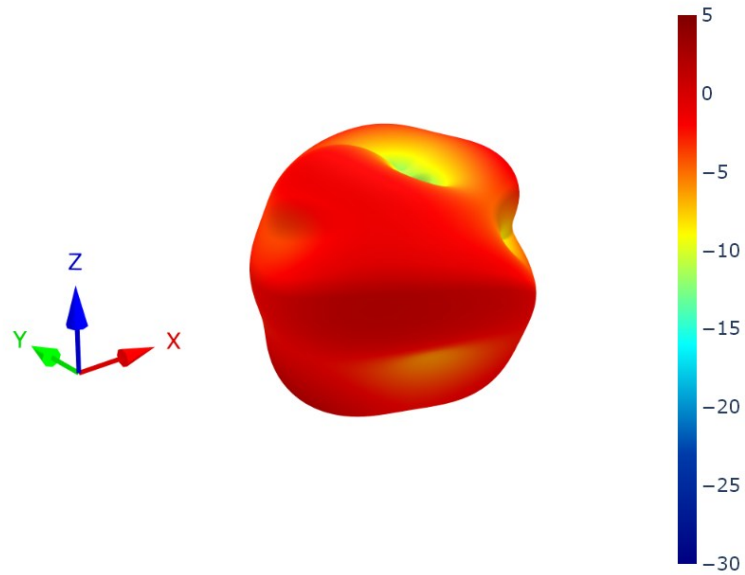

6.16 4G-5G 1 - Free Space Patterns at 890 MHz

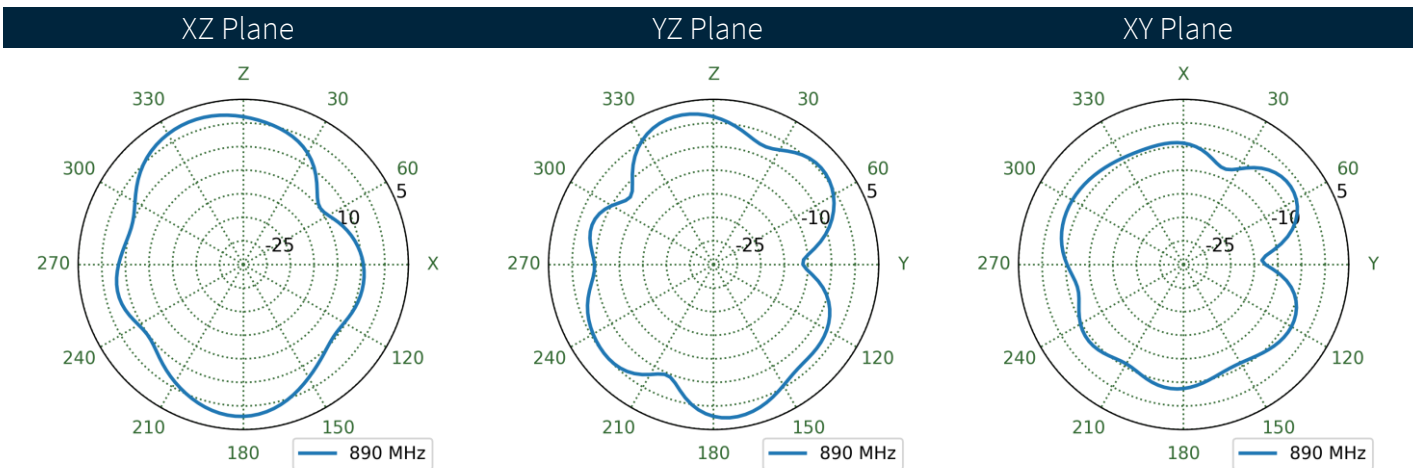
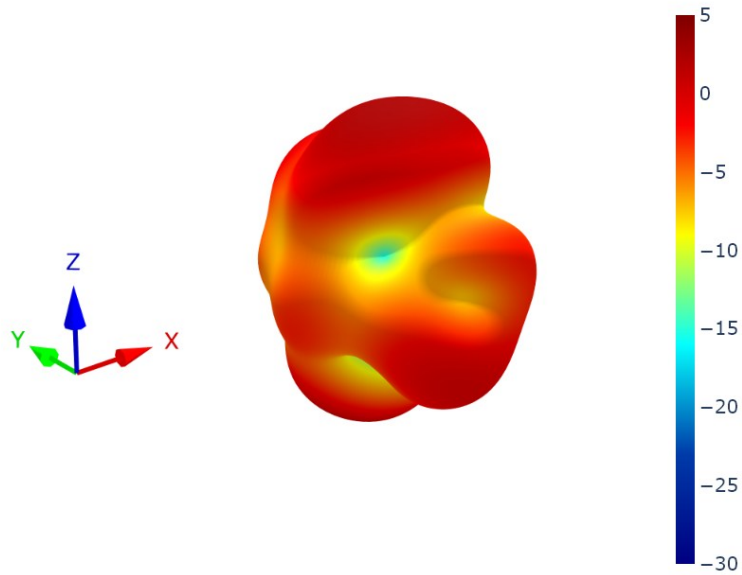

6.17 4G-5G 1 - Ground Plane Patterns at 890 MHz

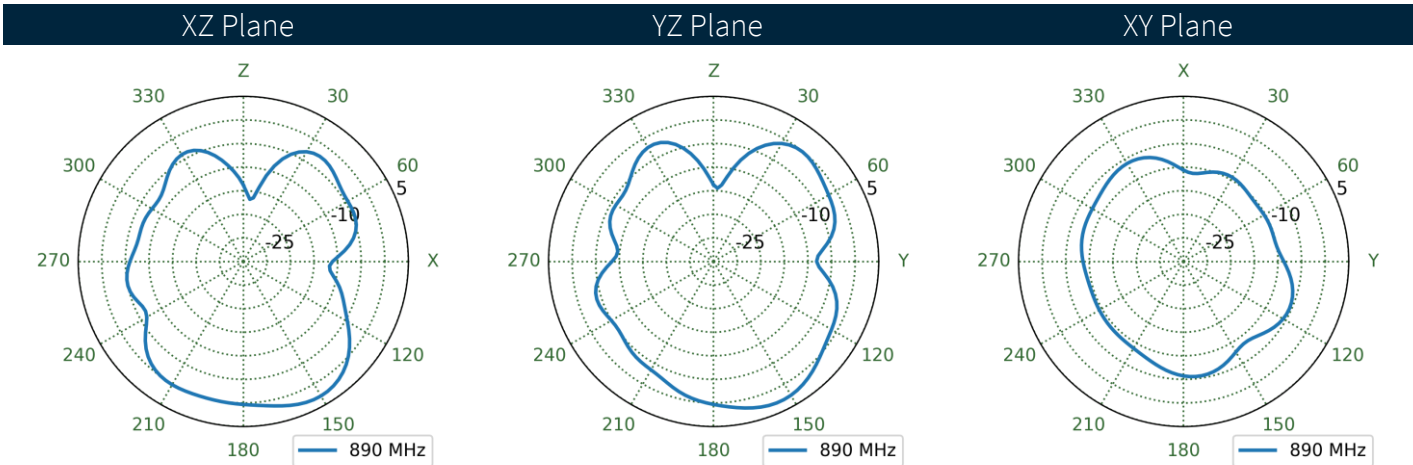
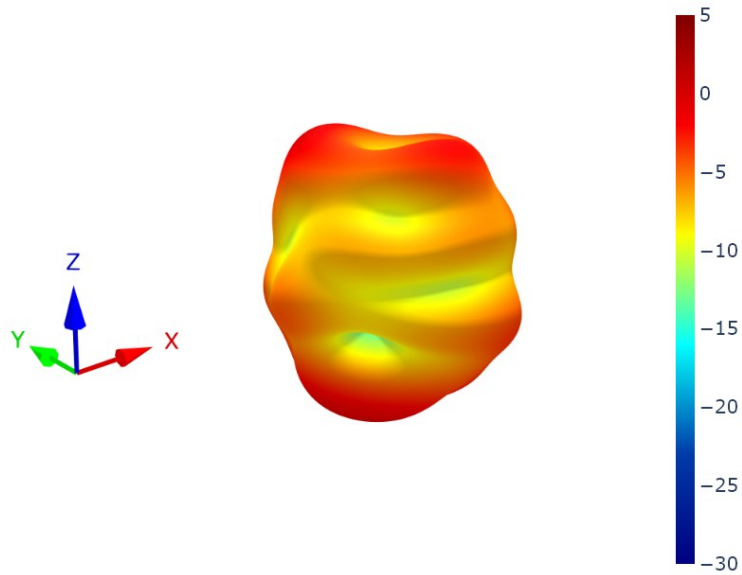

6.18 4G-5G 2 - Free Space Patterns at 890 MHz

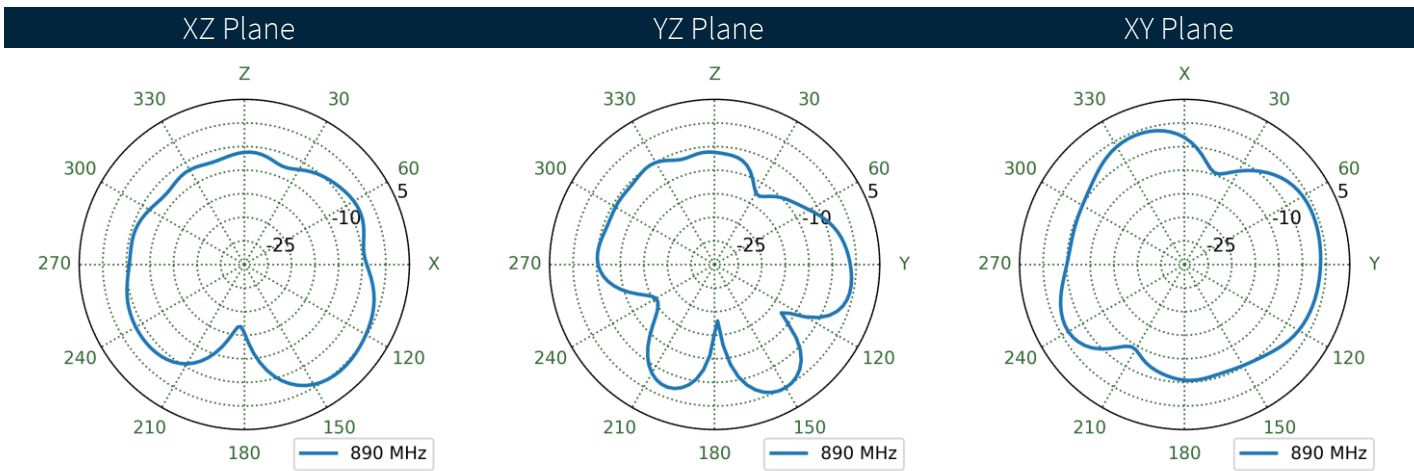
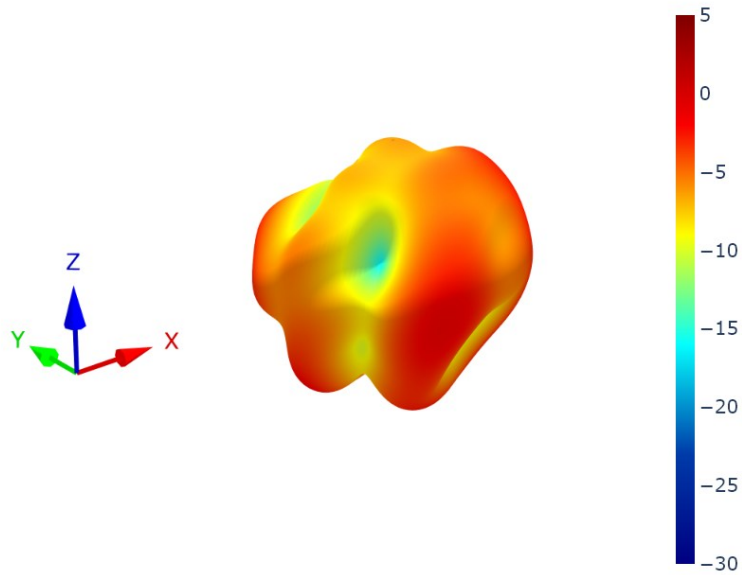

6.19 4G-5G 2 - Ground Plane Patterns at 890 MHz

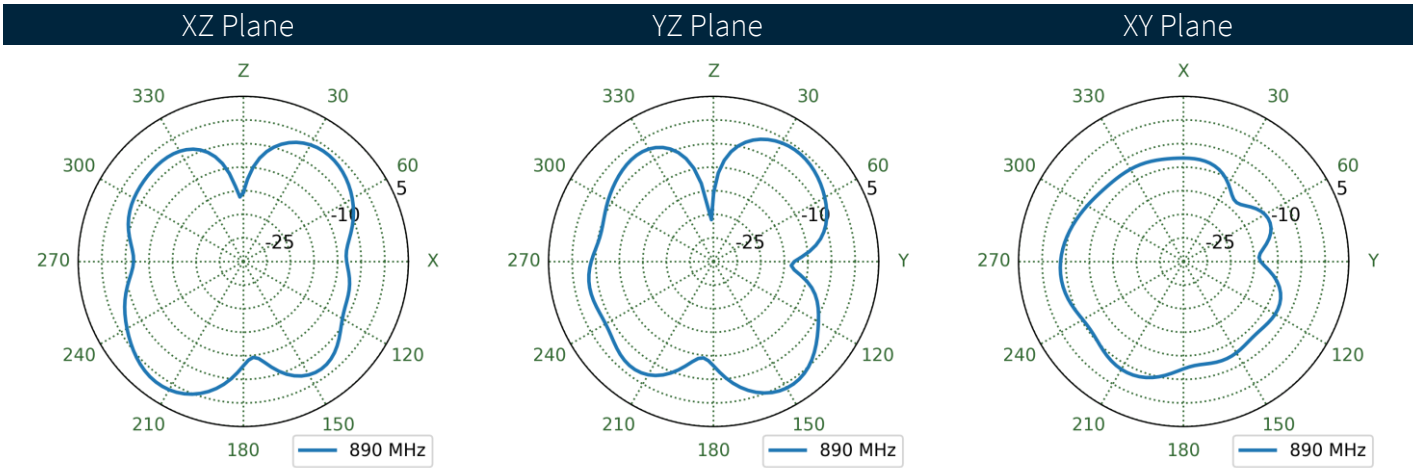
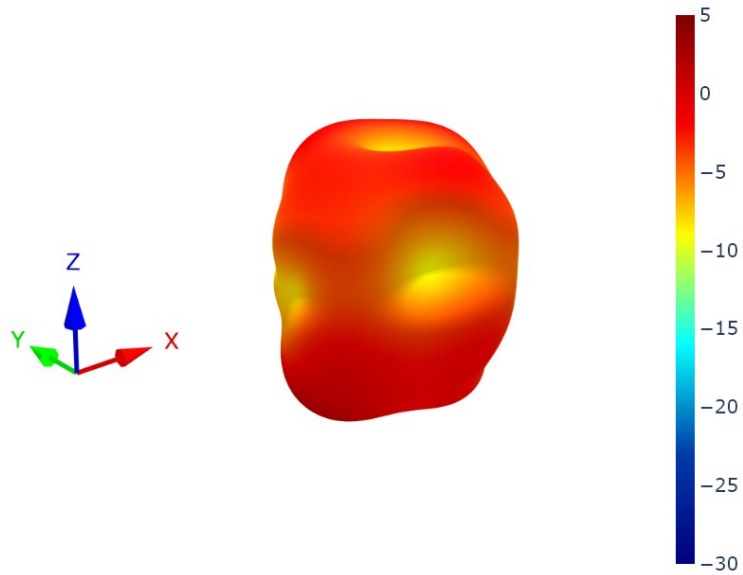

6.20 4G-5G 1 - Free Space Patterns at 1470 MHz

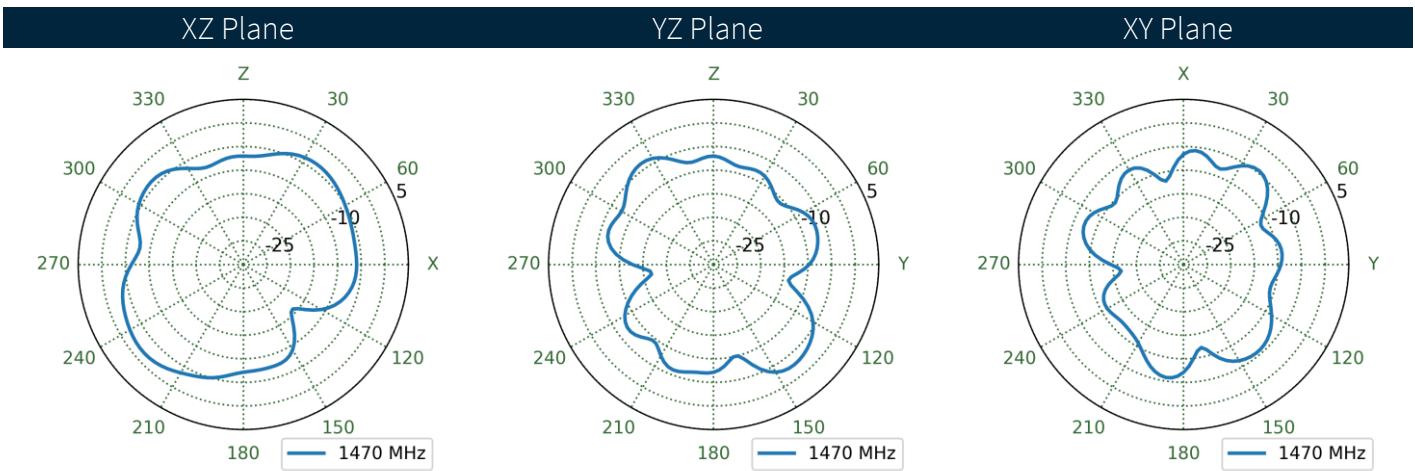
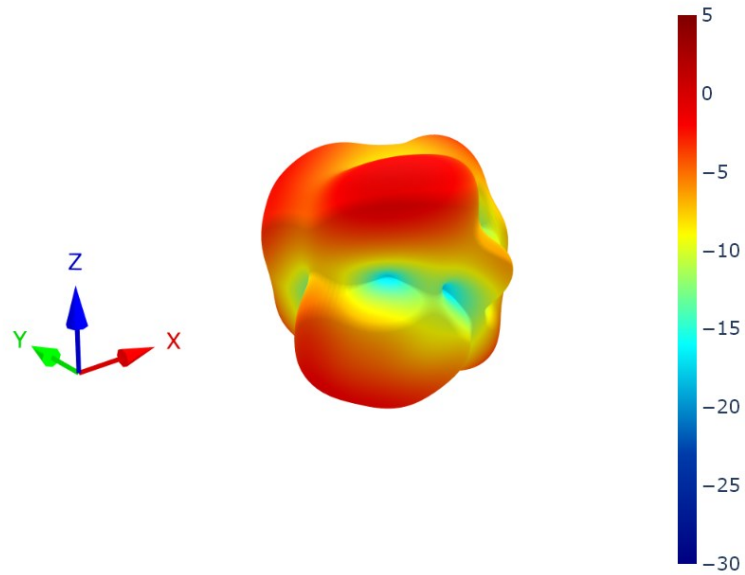

6.21 4G-5G 1 - Ground Plane Patterns at 1470 MHz

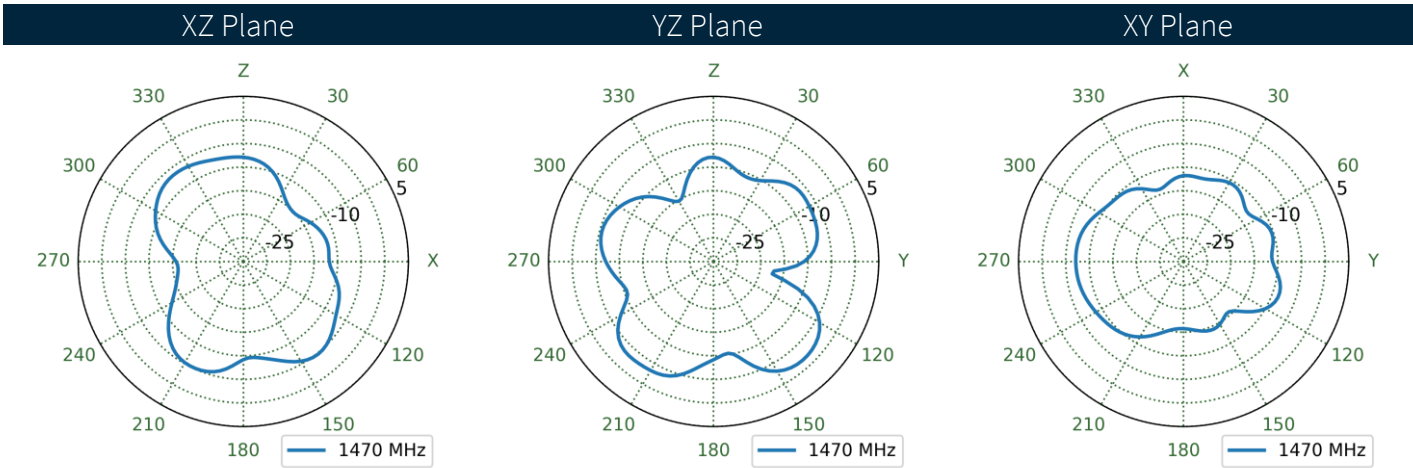
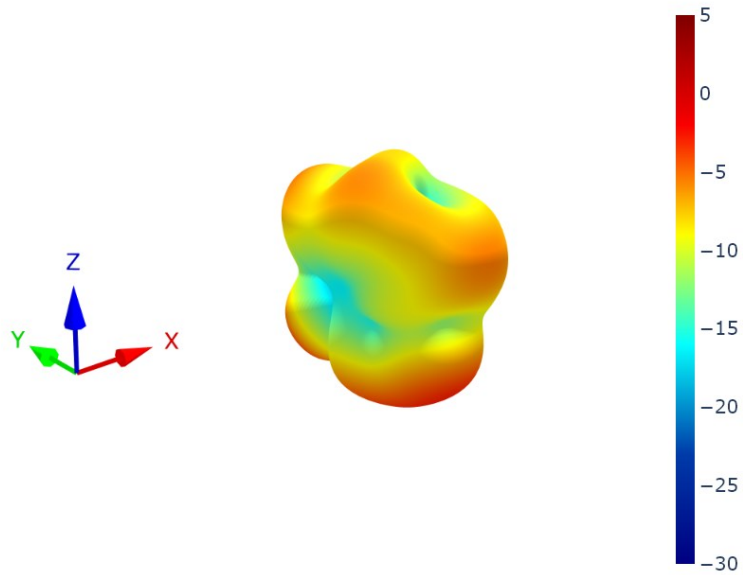

6.22 4G-5G 2 - Free Space Patterns at 1470 MHz

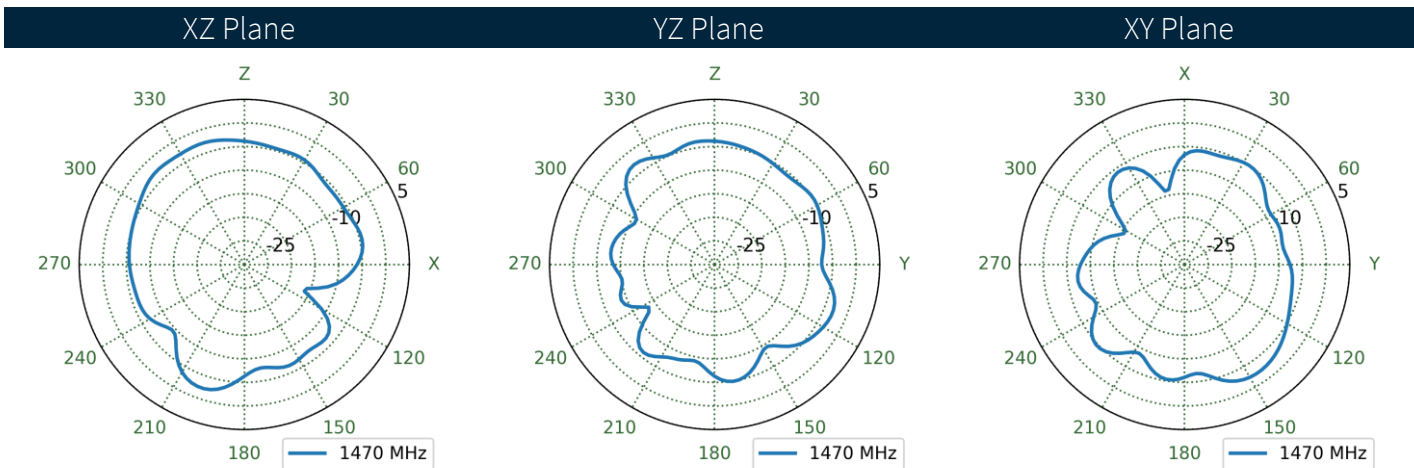
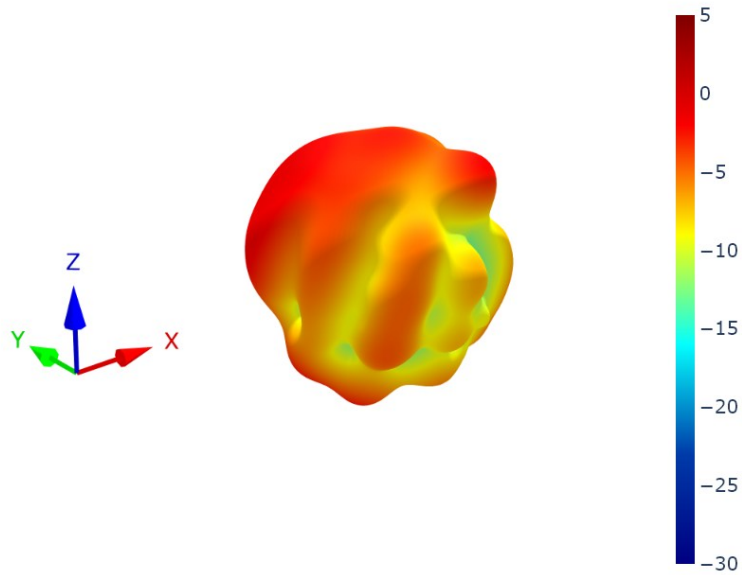

6.23 4G-5G 2 - Ground Plane Patterns at 1470 MHz

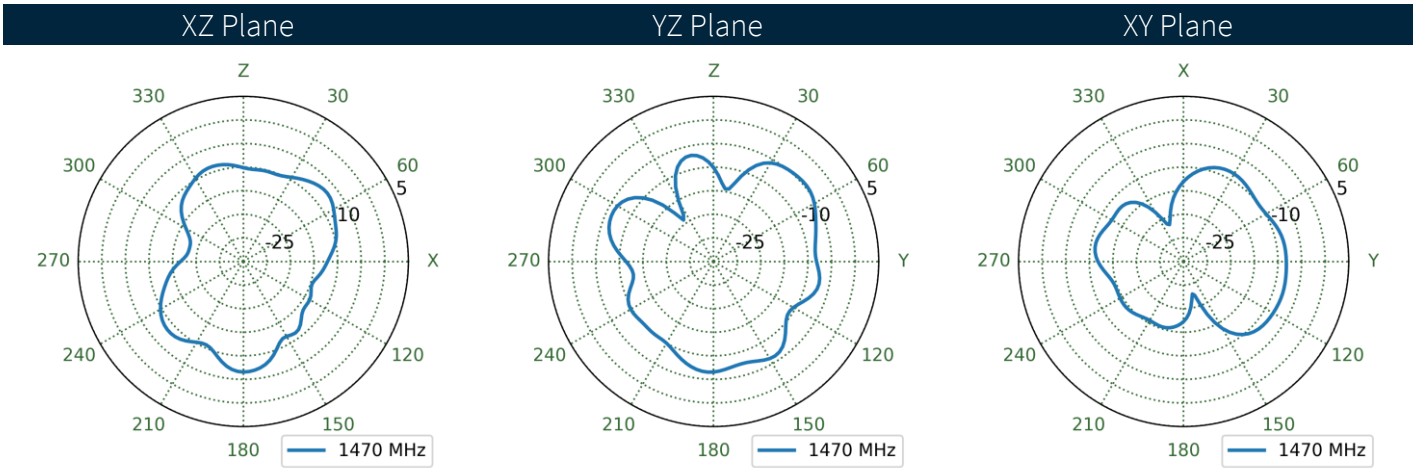
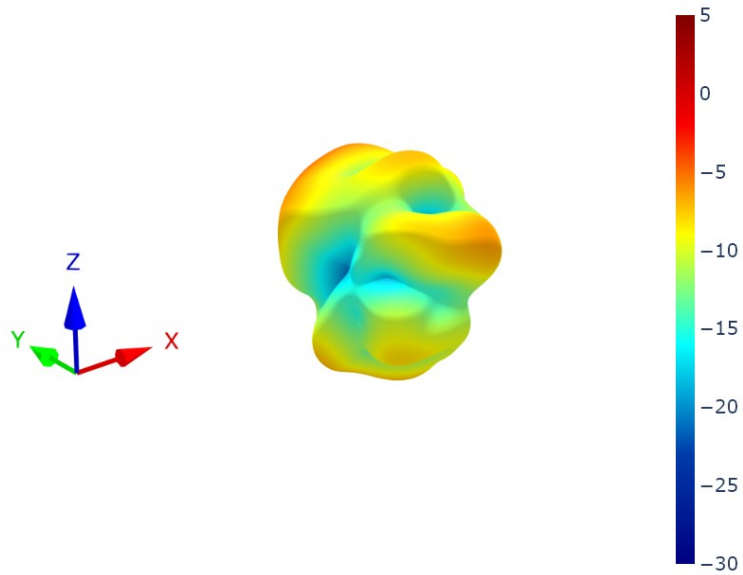

6.24 4G-5G 1 - Free Space Patterns at 1930 MHz

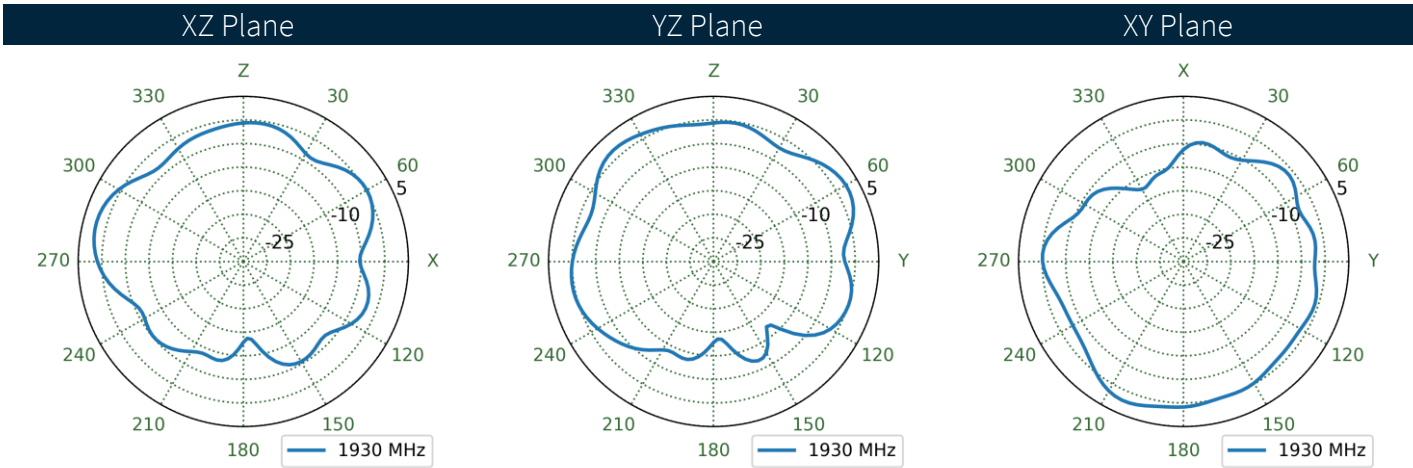
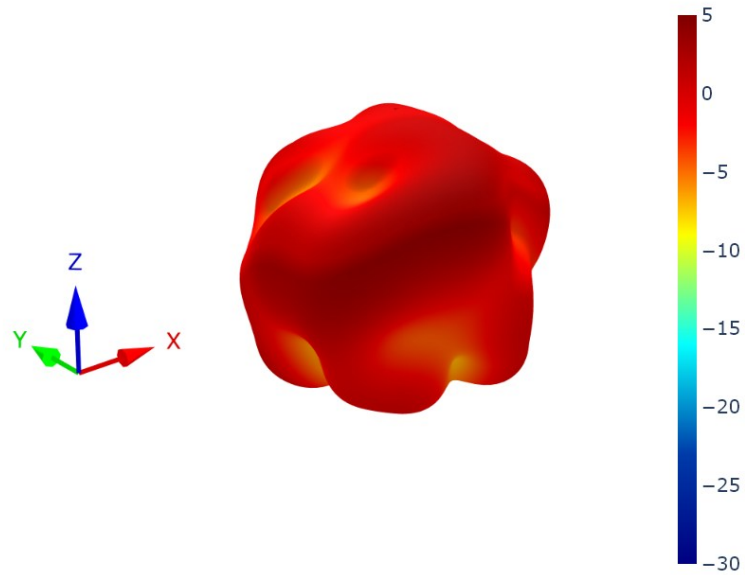

6.25 4G-5G 1 - Ground Plane Patterns at 1930 MHz

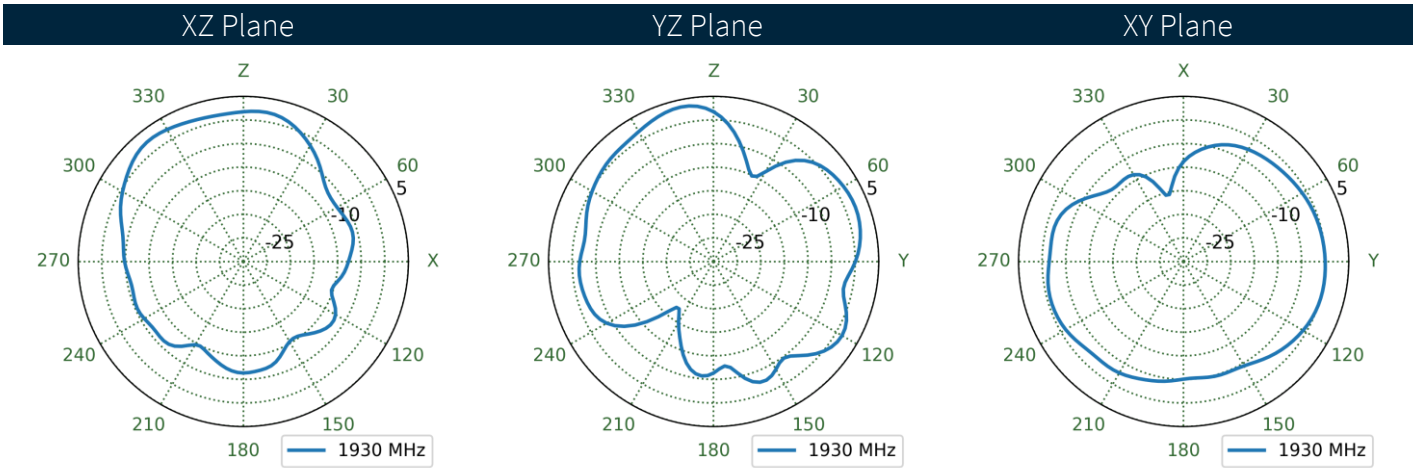
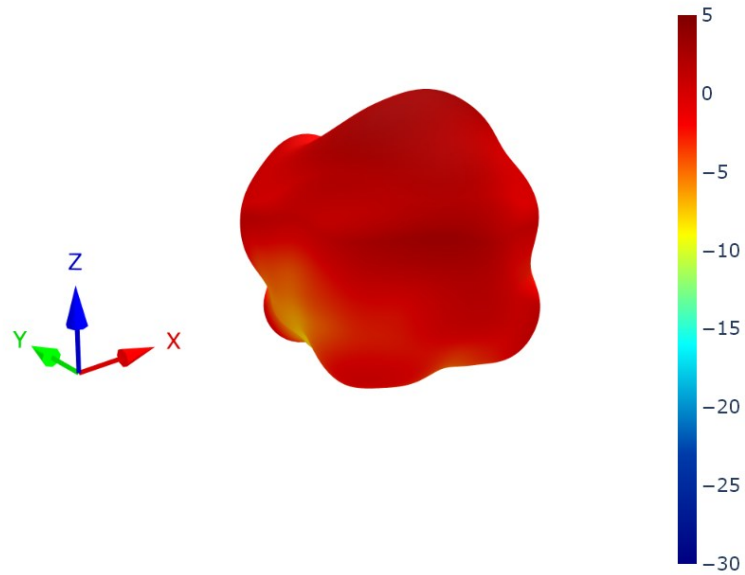

6.26 4G-5G 2 - Free Space Patterns at 1930 MHz

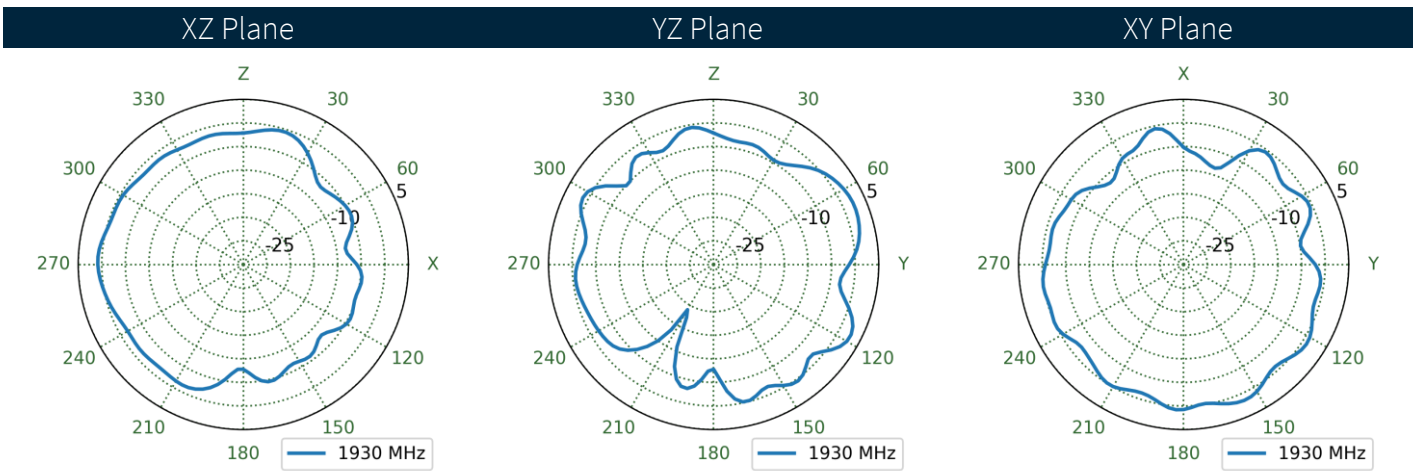
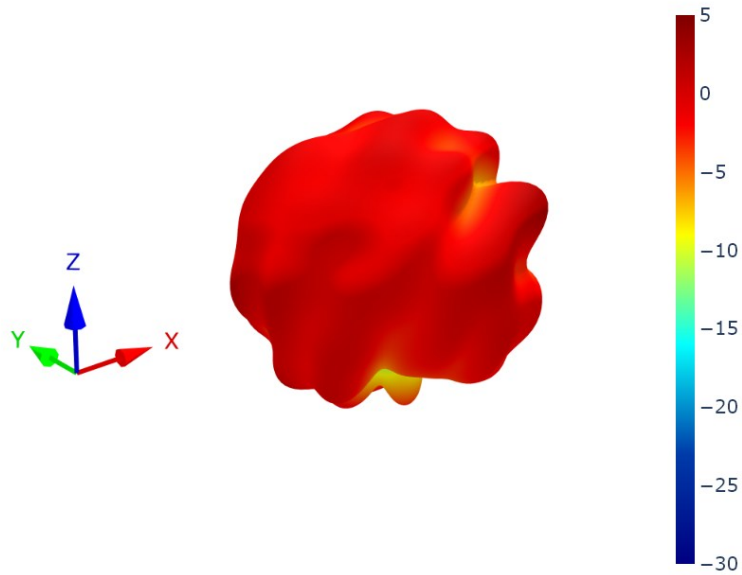

6.27 4G-5G 2 - Ground Plane Patterns at 1930 MHz

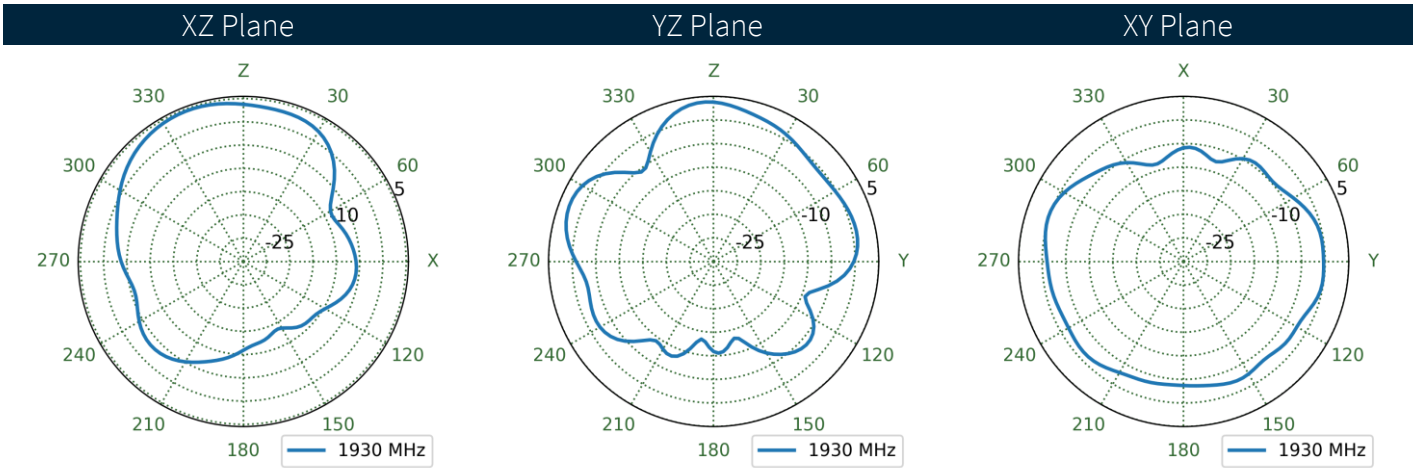
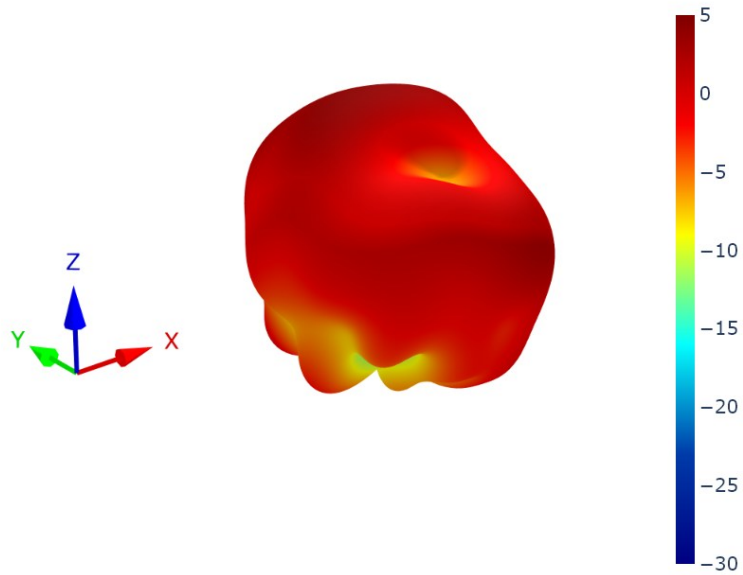

6.28 4G-5G 1 - Free Space Patterns at 2496 MHz

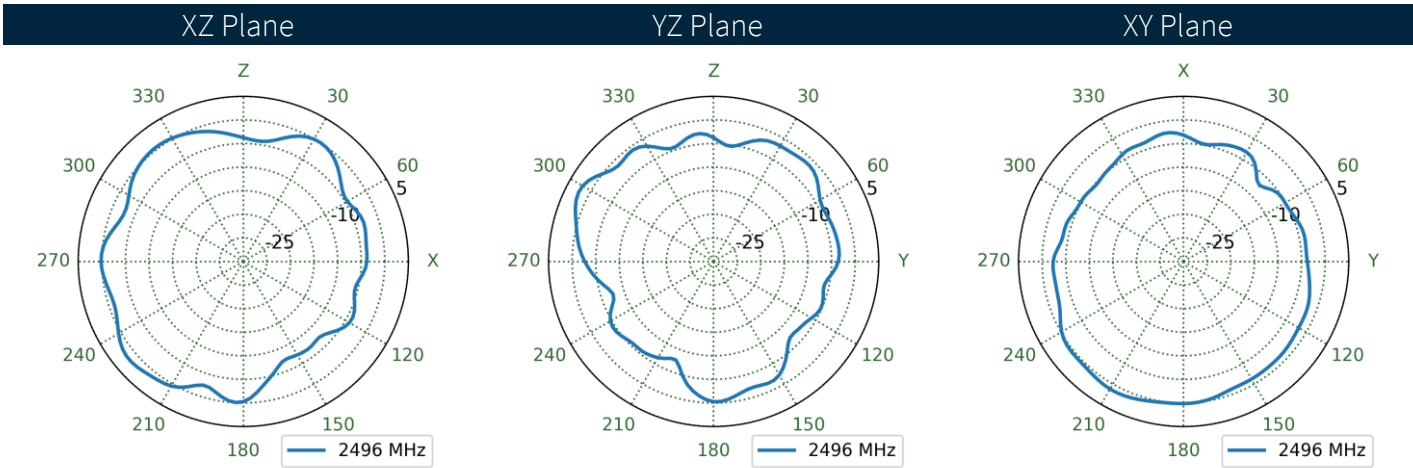
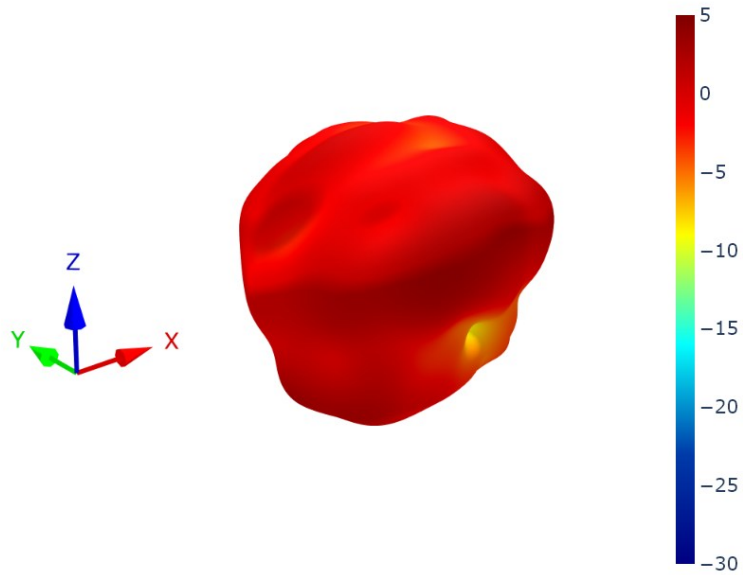

6.29 4G-5G 1 - Ground Plane Patterns at 2496 MHz

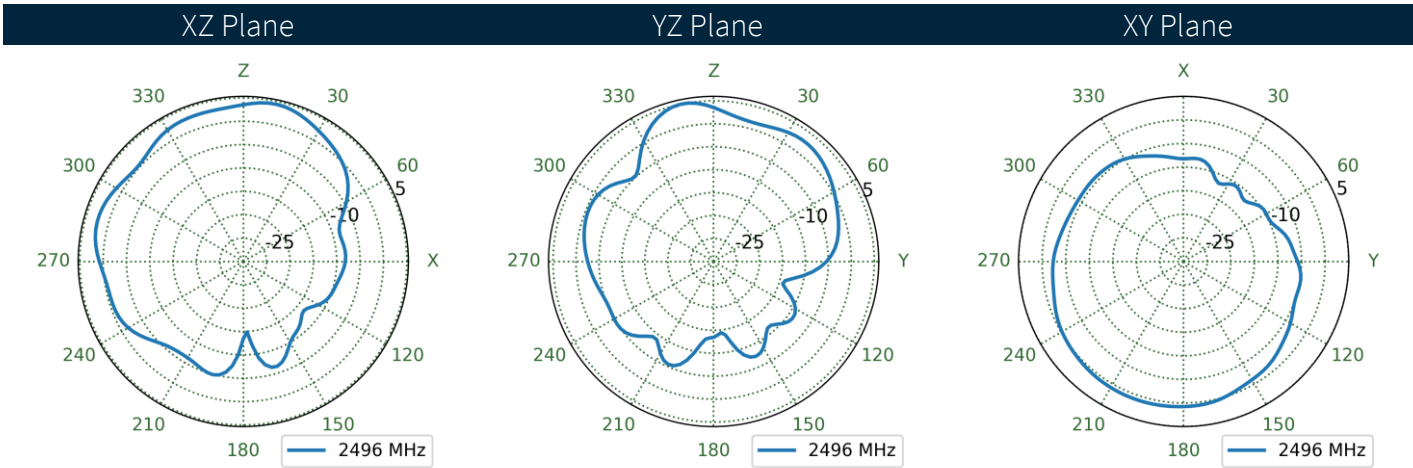
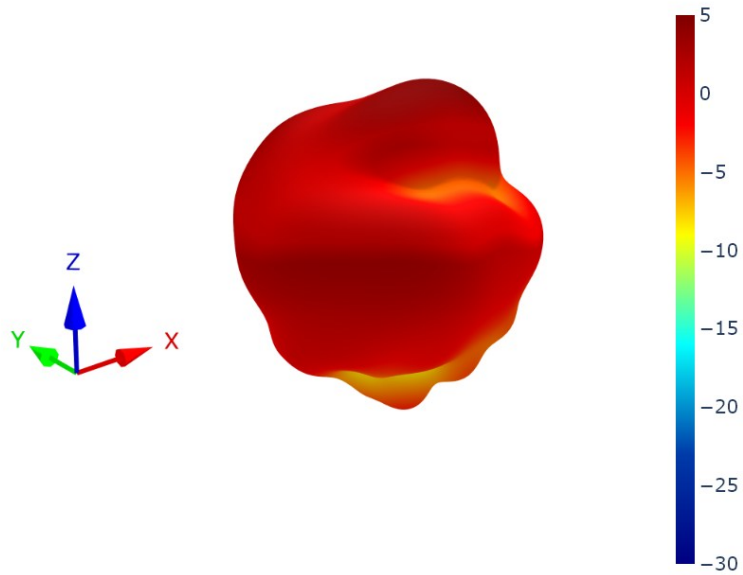

6.30 4G-5G 2 - Free Space Patterns at 2496 MHz

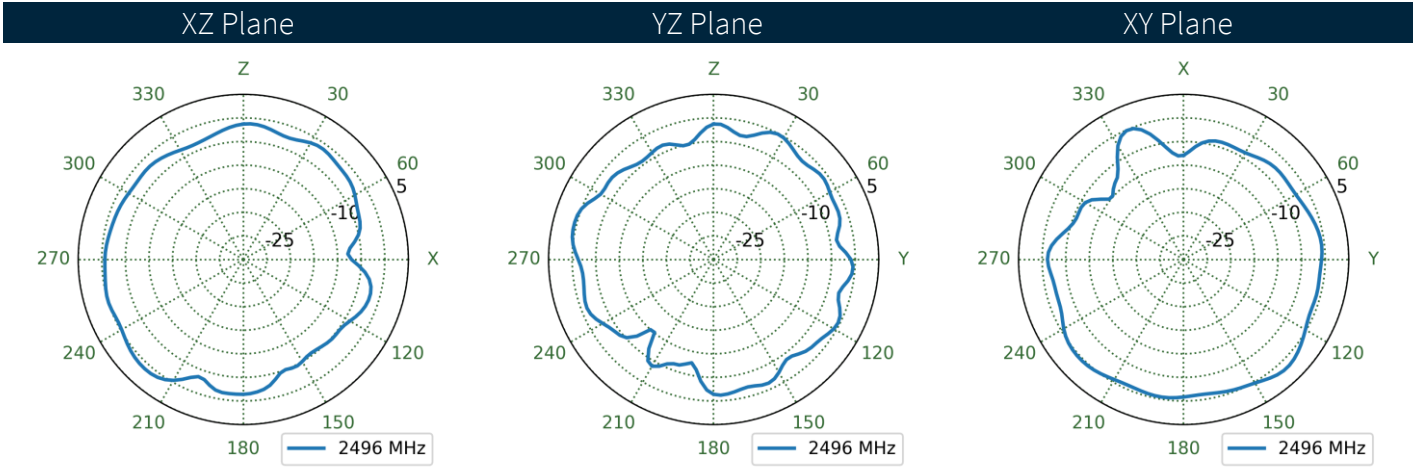
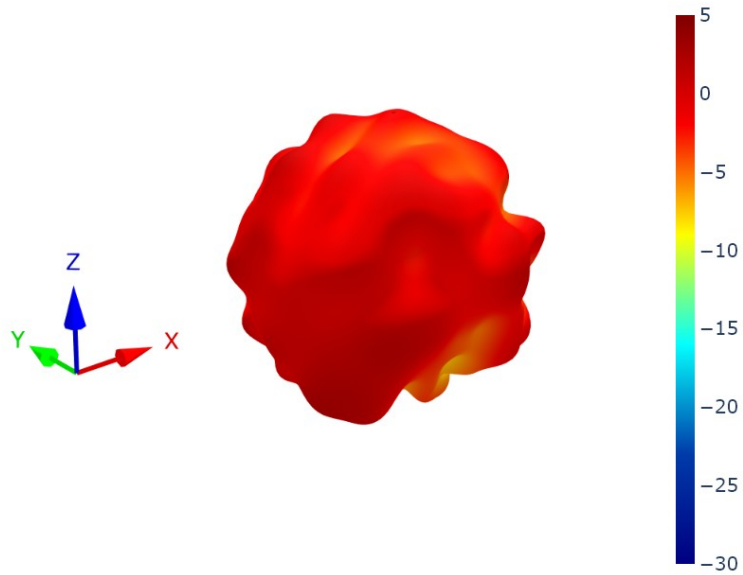

6.31 4G-5G 2 - Ground Plane Patterns at 2496 MHz

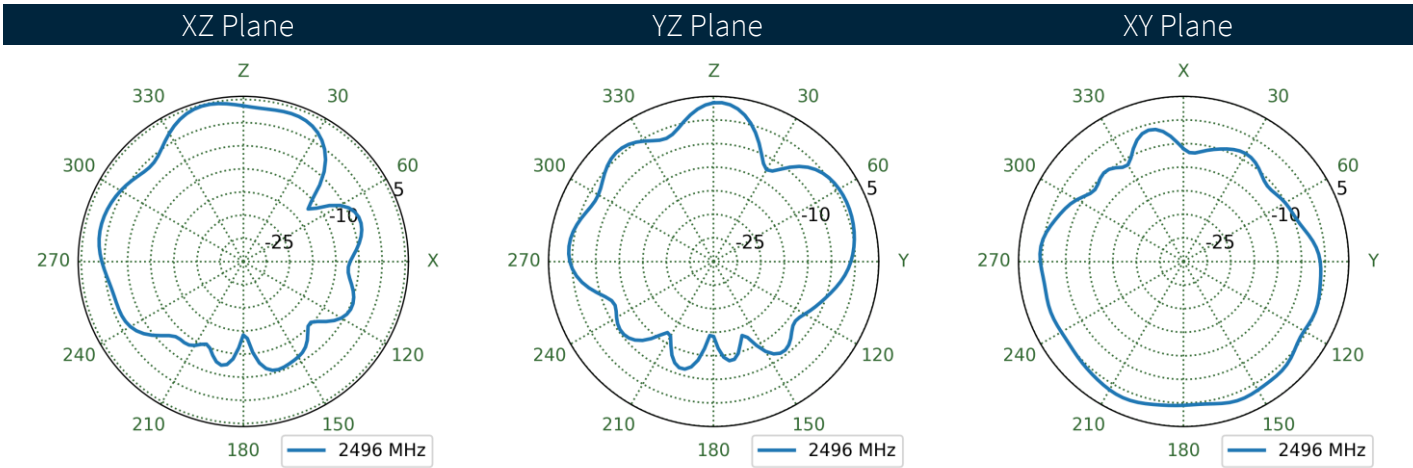
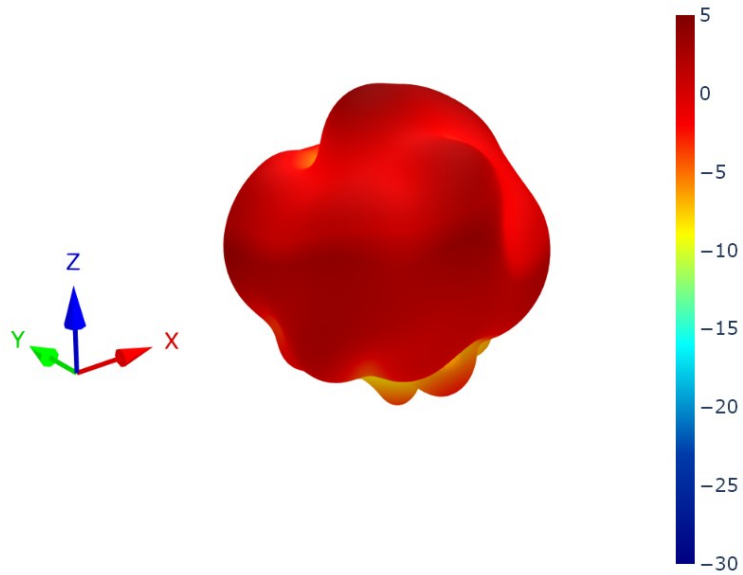

6.32 4G-5G 1 - Free Space Patterns at 4200 MHz

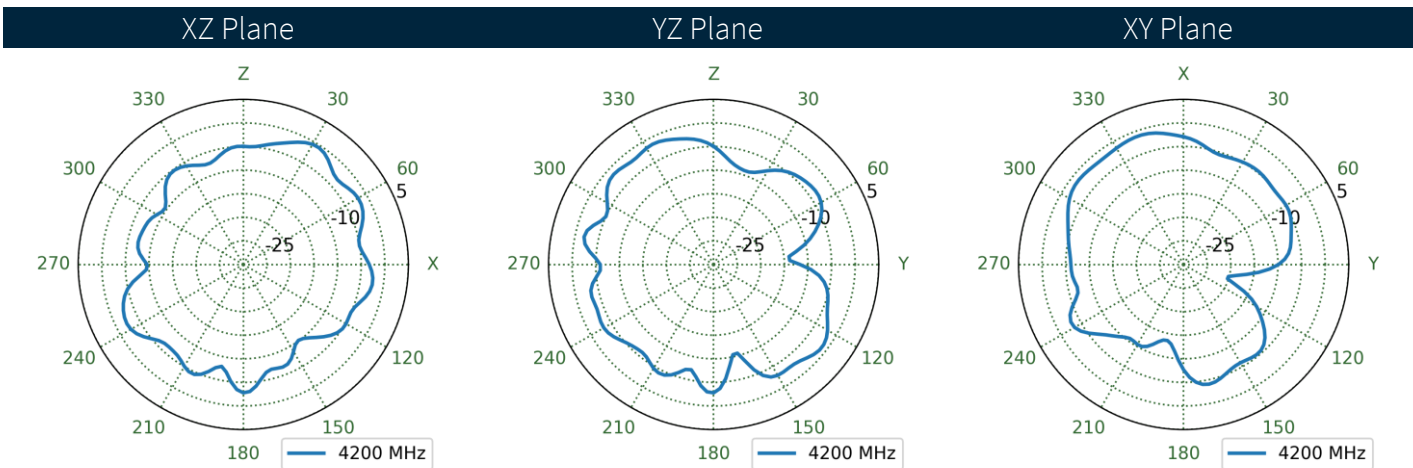
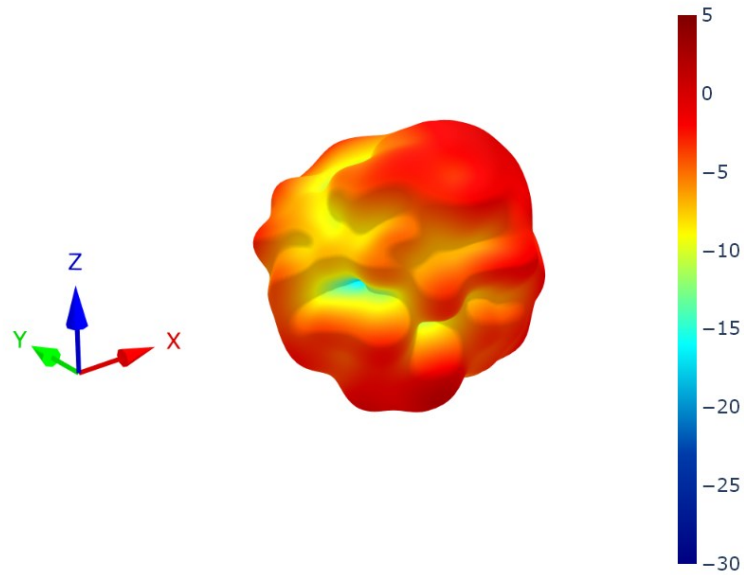

6.33 4G-5G 1 - Ground Plane Patterns at 4200 MHz

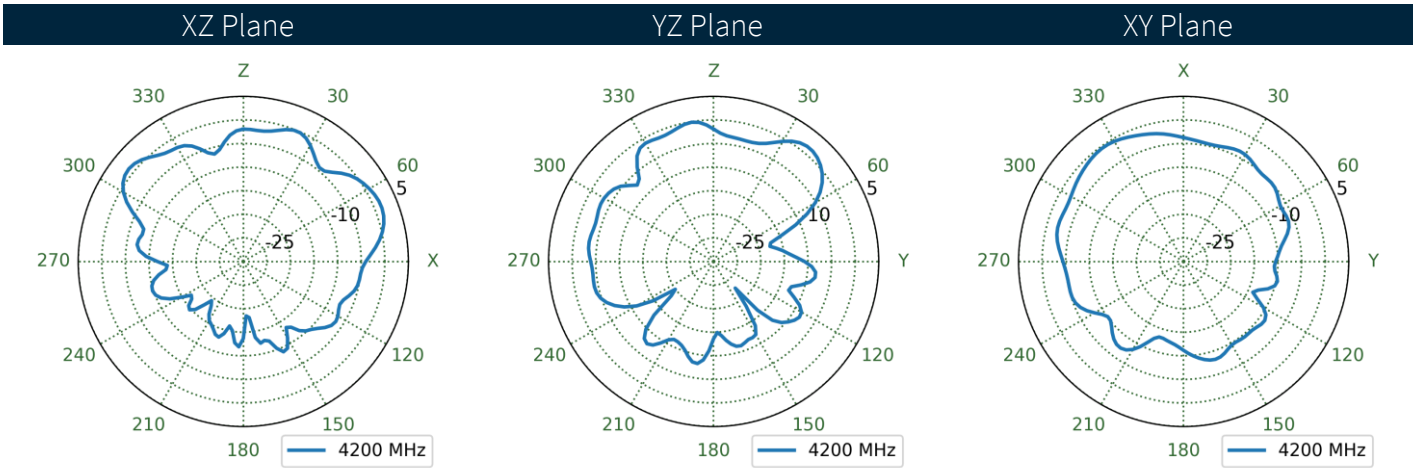
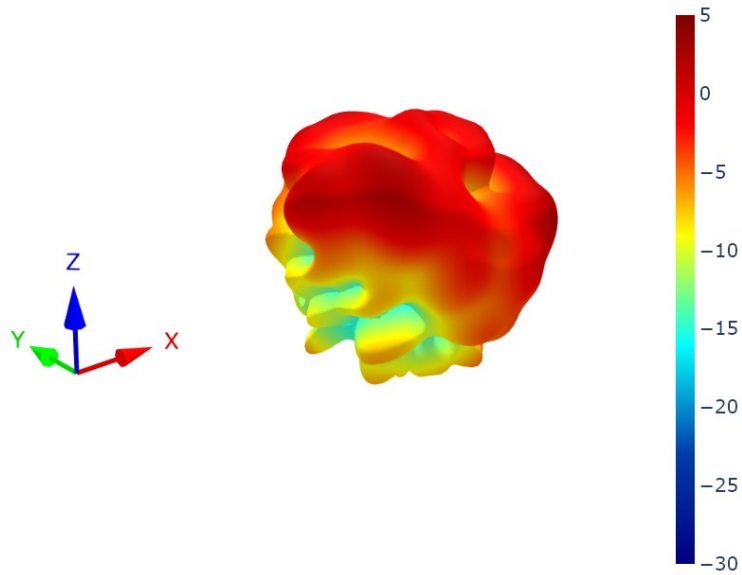

6.34 4G-5G 2 - Free Space Patterns at 4200 MHz

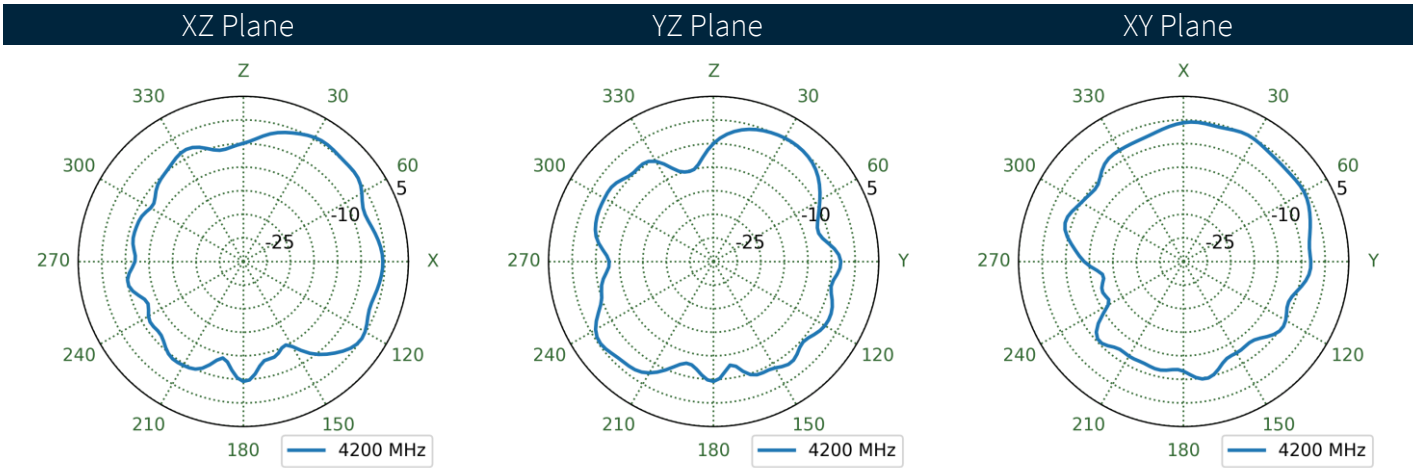
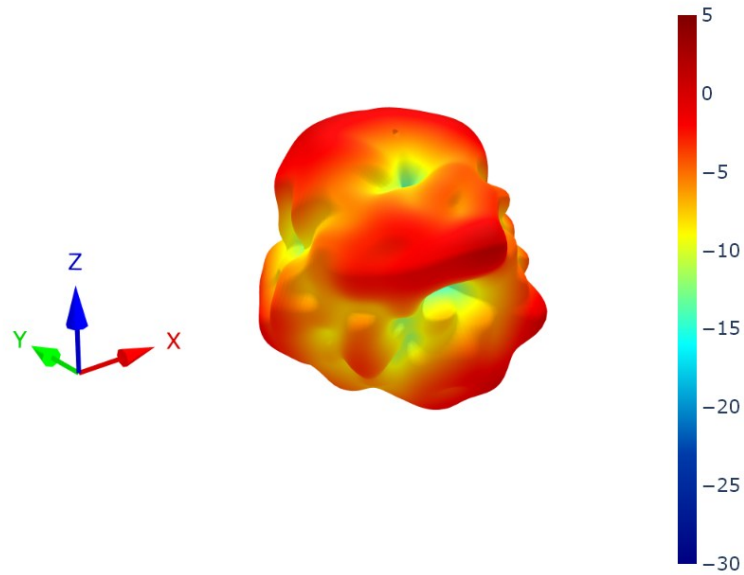

6.35 4G-5G 2 - Ground Plane Patterns at 4200 MHz

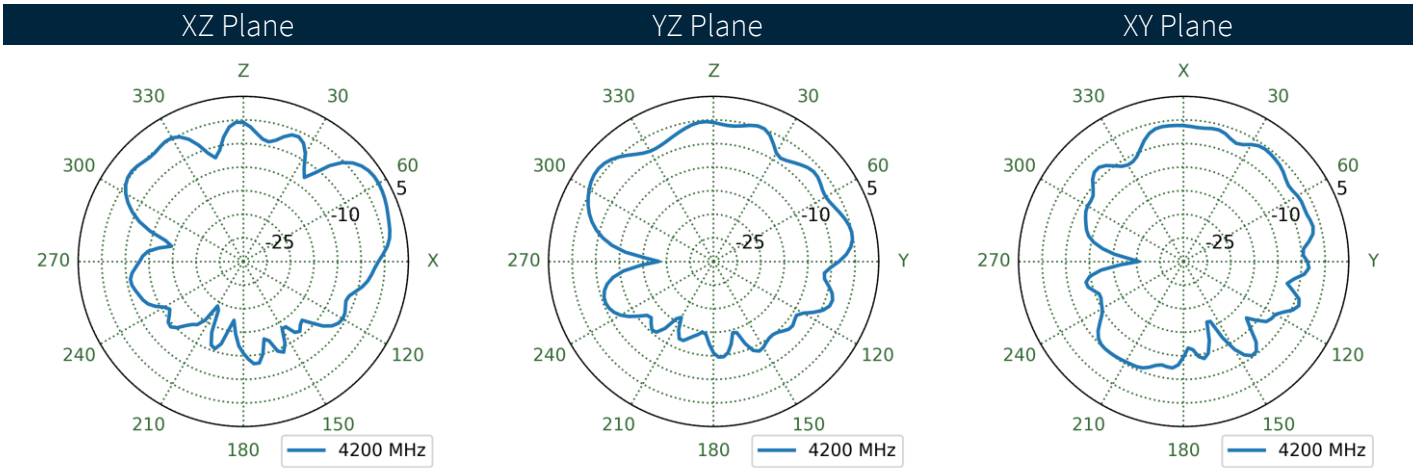
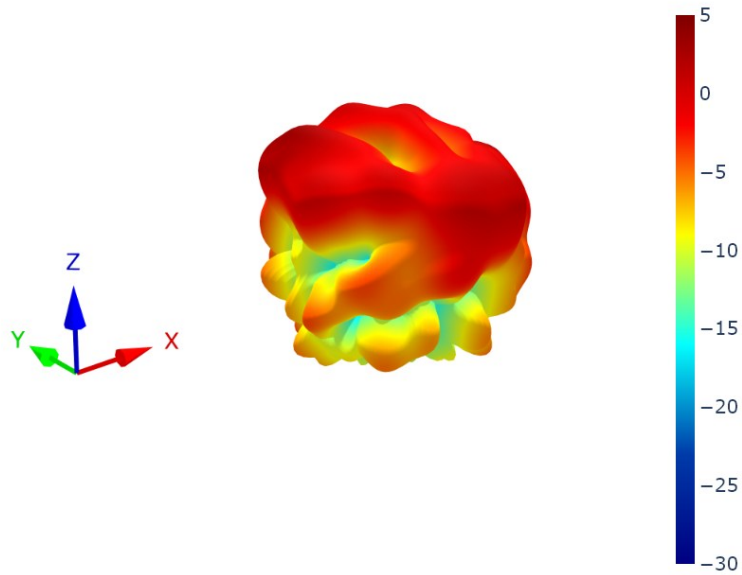

6.36 4G-5G 1 - Free Space Patterns at 5530 MHz

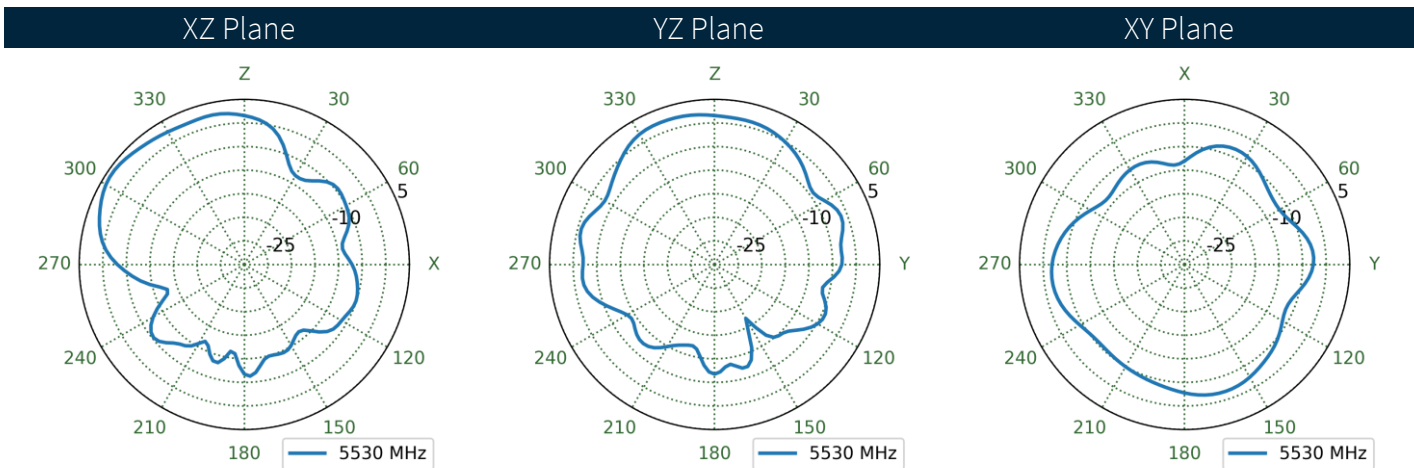
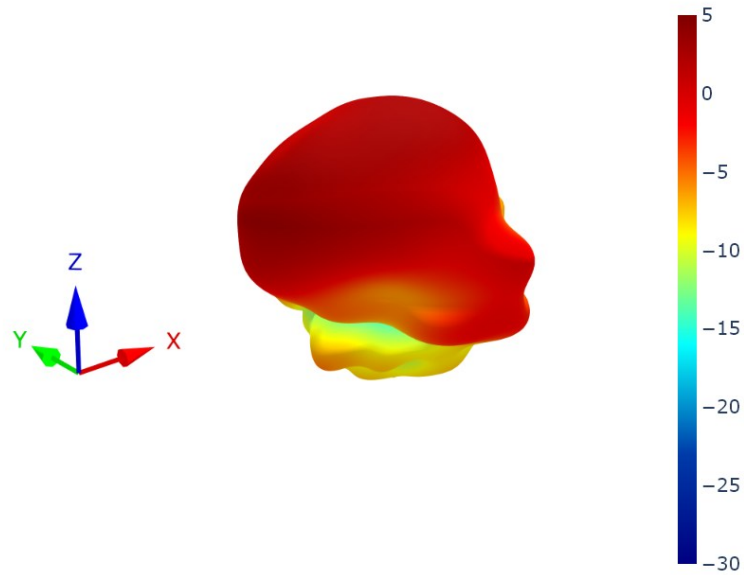

6.37 4G-5G 1 - Ground Plane Patterns at 5530 MHz

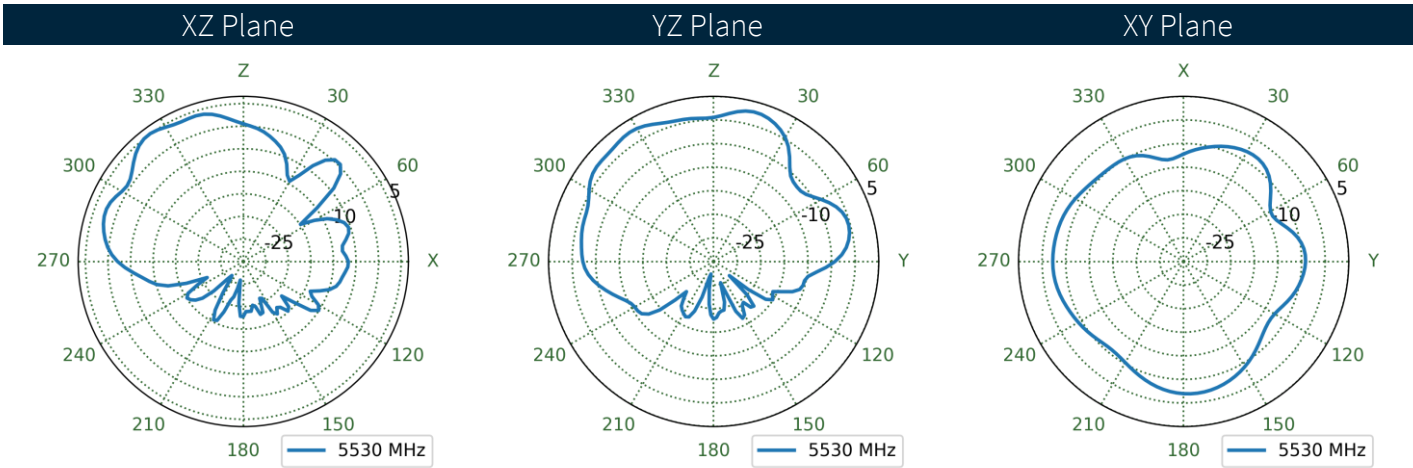
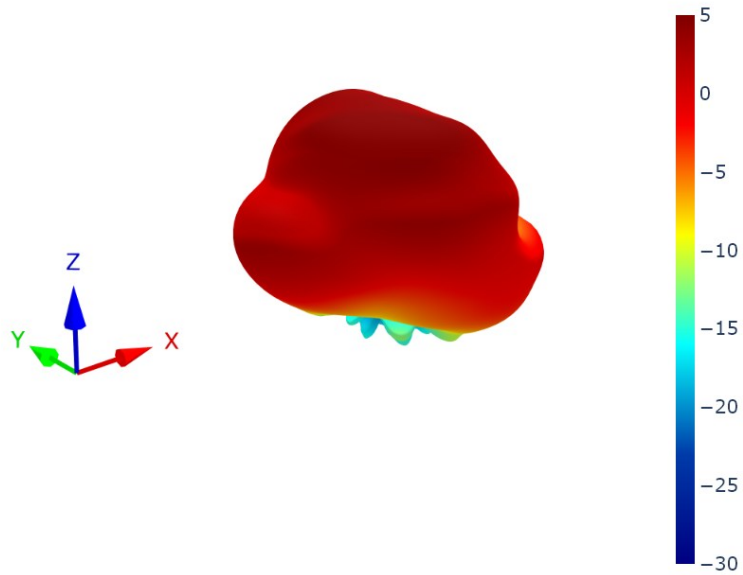

6.38 4G-5G 2 - Free Space Patterns at 5530 MHz

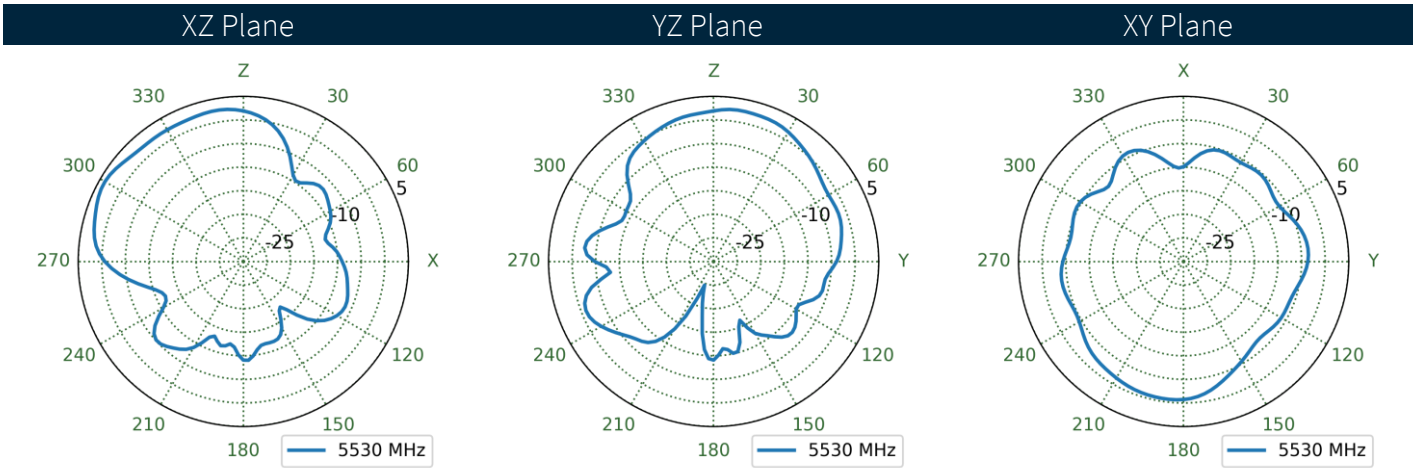
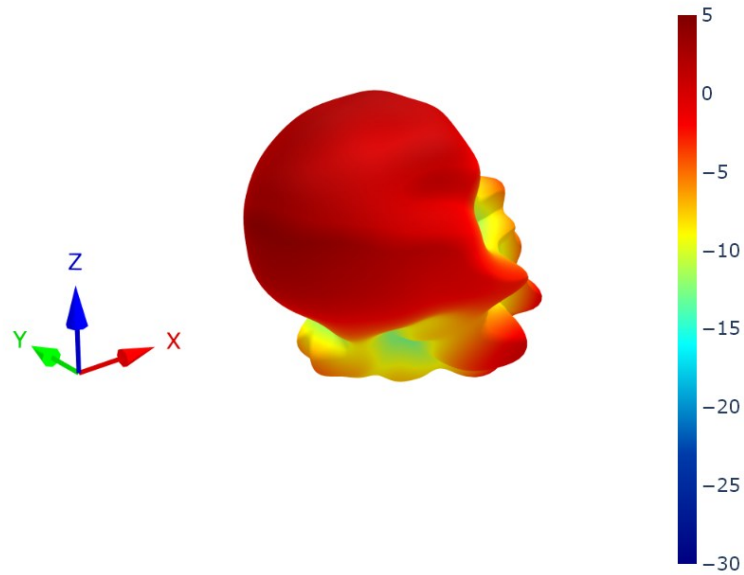

6.39 4G-5G 2 - Ground Plane Patterns at 5530 MHz

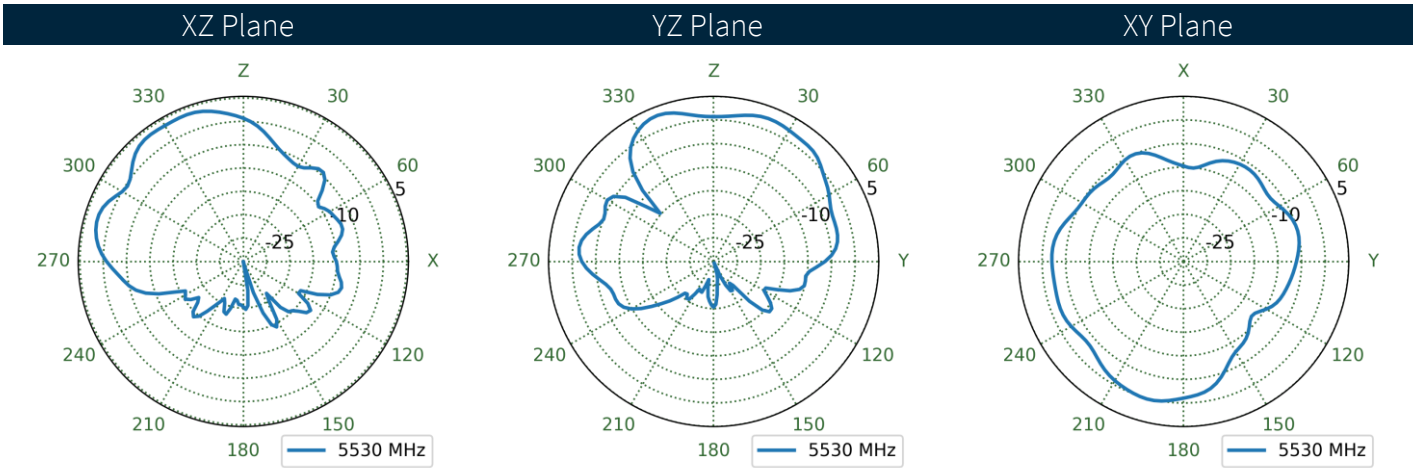
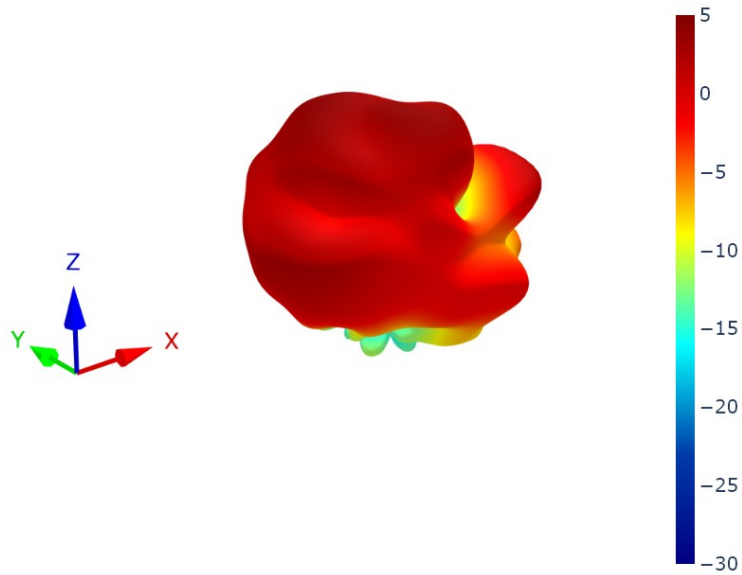

7. LNA Characteristics

7.1 Block Diagram

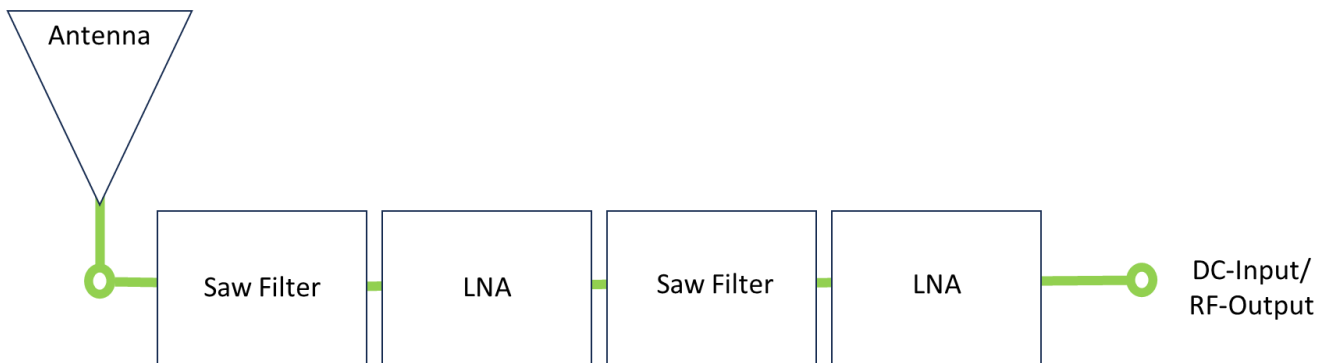

7.2 Noise Figure

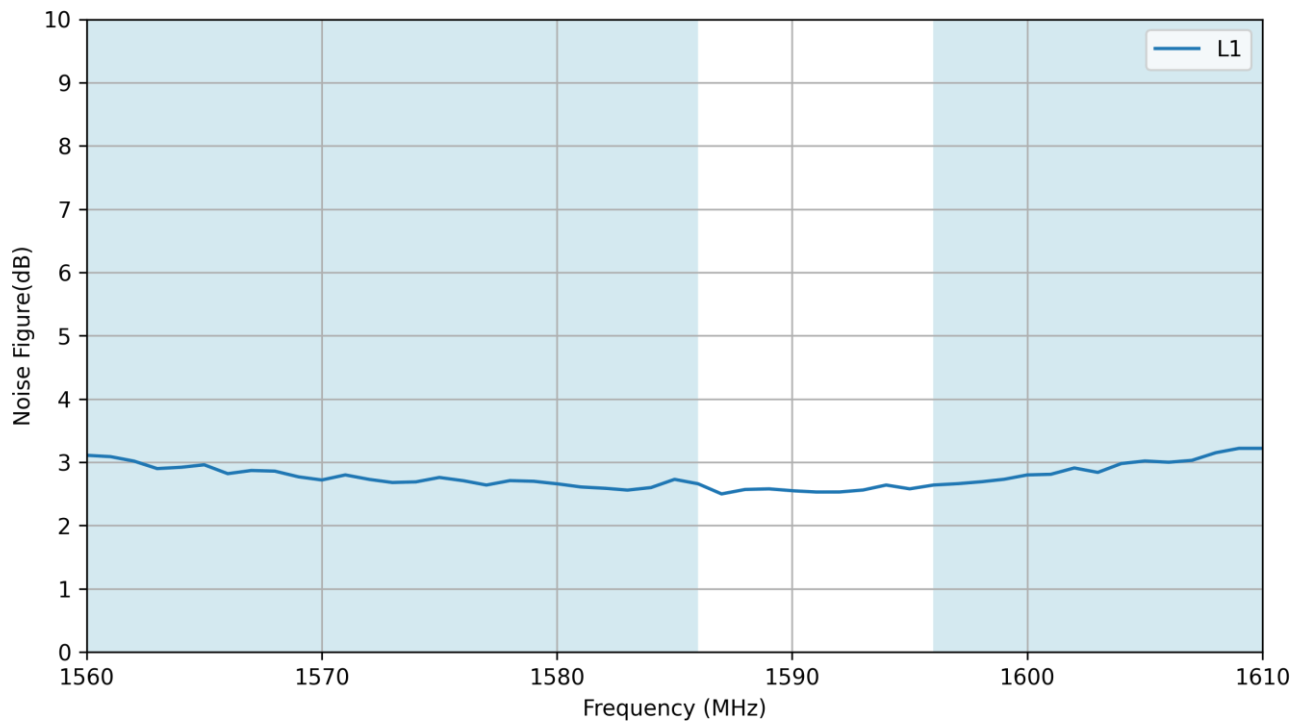

7.3 Gain

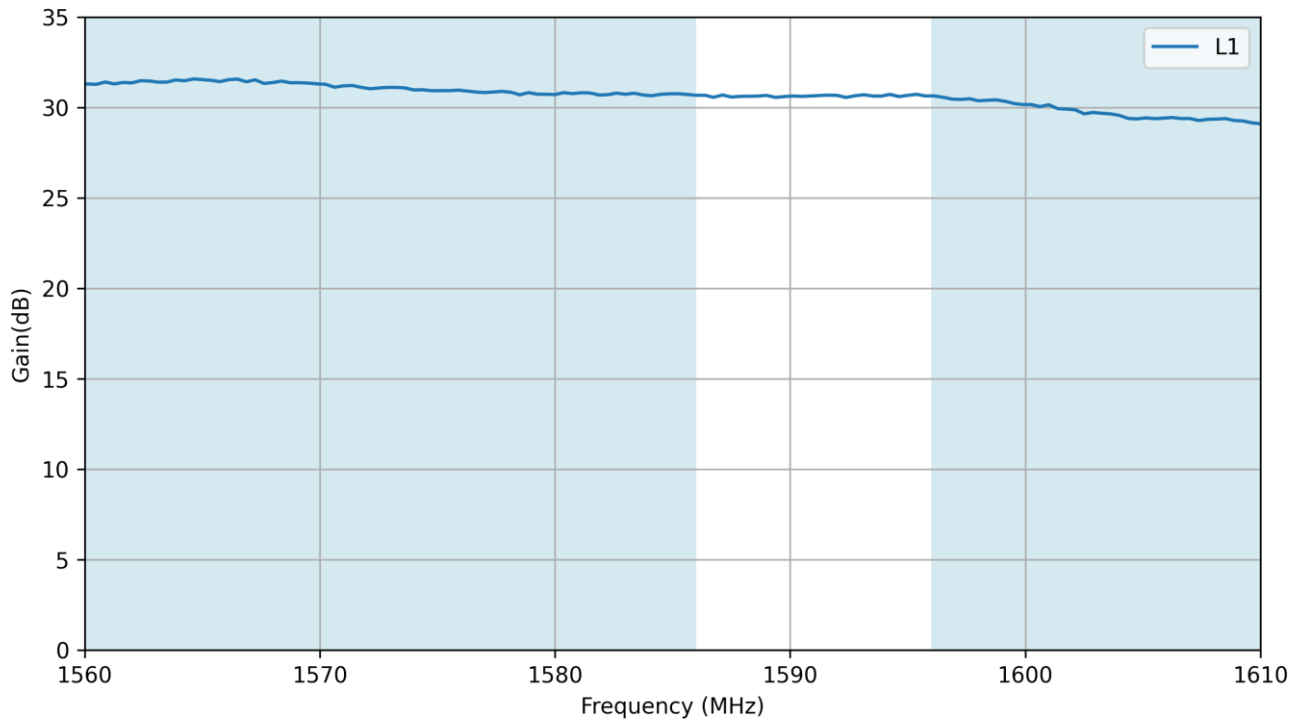

7.4 Out of Band Rejection

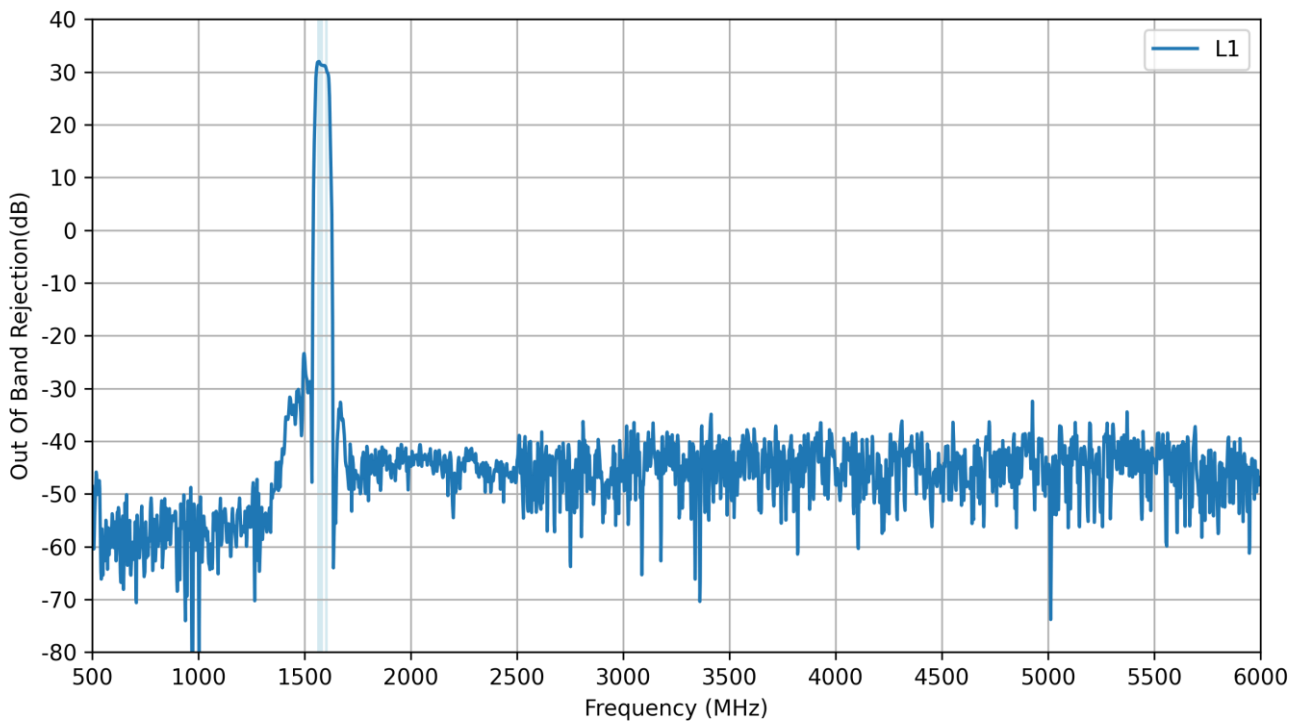

7.5 Group Delay

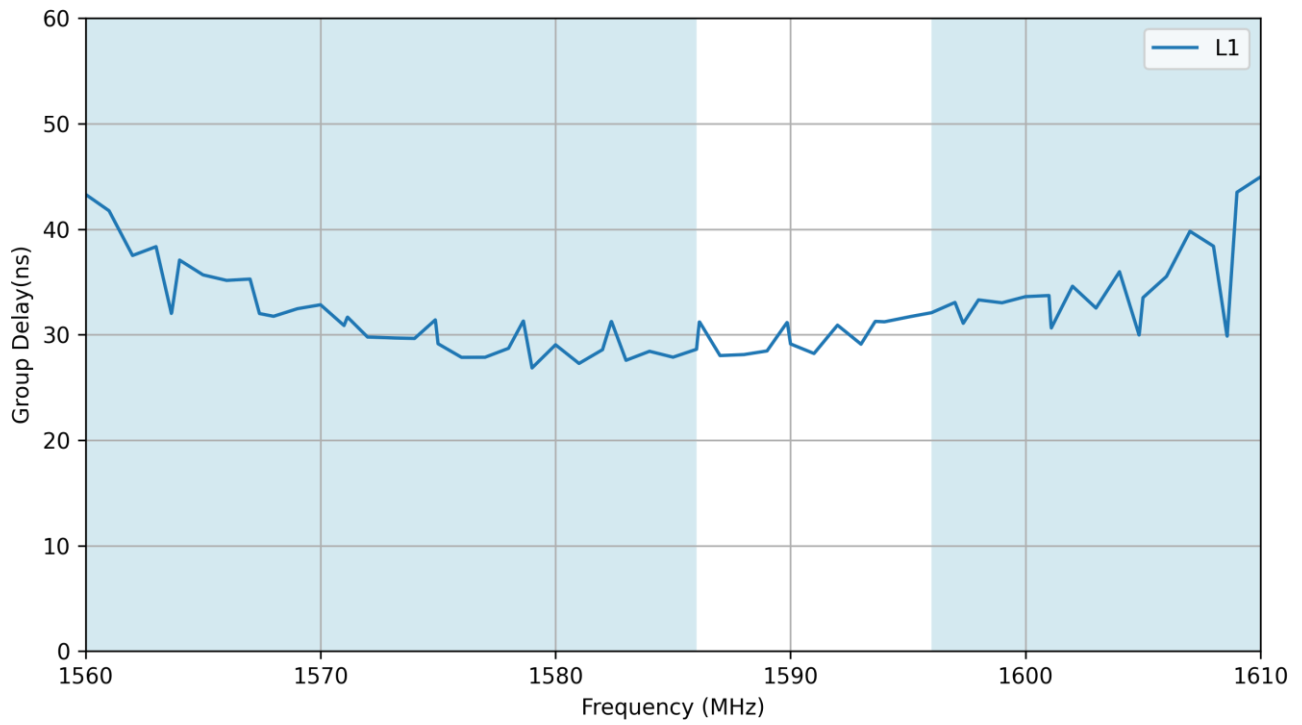

Changelog for the datasheet

SPE-24-8-297– MA181.W.001

Revision: A (Initial Release)

Date: 2024-12-05

Notes: Initial Datasheet Release

Author: Cesar Sousa

Previous Revisions



www.taoglas.com

