



TAOGLAS®



Datasheet

Olympian III

Part No:
MA182.W.001

Description

Olympian III White 2in1 Screw Mount 2*5G/4G with 1m TGC-1.5DS and SMA(M)

Features:

2* 5G/4G 4G-5G MIMO 600 to 6000MHz
IP67 Waterproof Enclosure
Dims: \varnothing 59.45mm x 70mm
Cables: LTE: 1m of TGC-1.5DS
Connectors: SMA(M)ST
Custom Cables and Connectors Available
RoHS & Reach Compliant

1.	Introduction	3
2.	Specification	4
3.	Mechanical Drawing	6
4.	Packaging	7
5.	Antenna Characteristics	8
6.	Radiation Patterns	12
<hr/>		
	Changelog	61

Taoglas makes no warranties based on the accuracy or completeness of the contents of this document and reserves the right to make changes to specifications and product descriptions at any time without notice. Taoglas reserves all rights to this document and the information contained herein. Reproduction, use or disclosure to third parties without express permission is strictly prohibited.

Ireland & USA
ISO 9001:2015
Certified



Taiwan
ISO 9001:2015
Certified



1. Introduction



The Taoglas Olympian III, MA182 is a high performance 2-in-1 combination 5G/4G MIMO permanent mount antenna in a compact housing at 70mm tall and 59mm in diameter. It is ideal for external use on vehicles and outdoor assets requiring 4G-5G MIMO connectivity.

The 5G/4G antenna, covers all worldwide LTE bands, includes many sub 6GHz, 5G FR1 bands and also includes fallback to 3G/2G bands where required, especially improving the design to eliminate the cable radiation to make the antenna will not be impacted after installed on a metal box. This makes MA182 antenna can be mounted on metal and plastic structures, and both works well. Taoglas recommend a minimum of 1m cable lengths for stable antenna performance.

The IP67 rated enclosure is made from a durable, ASA material that makes it resistant to vandalism. An integrated rubber O-ring under the enclosure prevents water ingress under the antenna. It is mounted from the inside of the user device enclosure and the small thread allows for installation in situations where space is minimal.

Typical Applications Include:

- Smart Metering and Remote Monitoring
- Digital Signage
- Transportation and Telematics

Cable and connectors are customizable. The MA182 can be supplied with low loss TGC-200 cable extensions for longer cable runs and also available in black (MA182.A.001). Please contact your regional Taoglas customer support team for further information.

2. Specification

4G-5G Electrical									
Band	Frequency (MHz)	Measurement	Efficiency (%)	Average Gain (dB)	Peak Gain (dBi)	Impedance	Polarization	Radiation Pattern	Max. input power
5GNR/4G Band71	617-698	4G-5G 1 - 30x30cm Ground Plane	58.5	-2.33	6.79	50 Ω	Linear	Omni	2W
		4G-5G 1 - Free Space	33.3	-4.77	1.08				
		4G-5G 1 - MetalBox	37.8	-4.23	0.60				
		4G-5G 2 - 30x30cm Ground Plane	47.4	-3.24	5.44				
		4G-5G 2 - Free Space	26.5	-5.77	0.33				
		4G-5G 2 - MetalBox	38.1	-4.19	-0.01				
4G/3G Band 12,13,14,17,28,29	698-806	4G-5G 1 - 30x30cm Ground Plane	53.6	-2.71	5.10				
		4G-5G 1 - Free Space	47.9	-3.19	2.38				
		4G-5G 1 - MetalBox	30.3	-5.19	0.60				
		4G-5G 2 - 30x30cm Ground Plane	53.7	-2.70	4.59				
		4G-5G 2 - Free Space	41.9	-3.78	1.12				
		4G-5G 2 - MetalBox	38.5	-4.14	0.33				
4G/3G/NB-IoT/Cat M Band 5,8,18,19,20,26,27	824-960	4G-5G 1 - 30x30cm Ground Plane	55.5	-2.55	5.48				
		4G-5G 1 - Free Space	61.1	-2.14	4.63				
		4G-5G 1 - MetalBox	35.4	-4.51	2.26				
		4G-5G 2 - 30x30cm Ground Plane	57.4	-2.41	4.16				
		4G-5G 2 - Free Space	58.6	-2.32	3.26				
		4G-5G 2 - MetalBox	22.3	-6.52	0.78				
5GNR/4G Band 21,32,74,75,76	1427-1518	4G-5G 1 - 30x30cm Ground Plane	13.8	-8.60	-0.01				
		4G-5G 1 - Free Space	23.1	-6.37	0.03				
		4G-5G 1 - MetalBox	6.8	-11.67	-2.57				
		4G-5G 2 - 30x30cm Ground Plane	19.3	-7.15	0.47				
		4G-5G 2 - Free Space	21.7	-6.63	-0.49				
		4G-5G 2 - MetalBox	5.0	-13.04	-2.50				
4G/3G Band 1,2,3,4,9,23,25,35,39,66	1710-2200	4G-5G 1 - 30x30cm Ground Plane	60.9	-2.16	4.42				
		4G-5G 1 - Free Space	70.4	-1.52	4.39				
		4G-5G 1 - MetalBox	56.7	-2.47	4.84				
		4G-5G 2 - 30x30cm Ground Plane	66.4	-1.78	4.50				
		4G-5G 2 - Free Space	67.2	-1.73	5.23				
		4G-5G 2 - MetalBox	55.8	-2.53	4.67				
4G/3G Band 7,30,38,40,41	2300-2690	4G-5G 1 - 30x30cm Ground Plane	67.6	-1.70	5.49				
		4G-5G 1 - Free Space	64.9	-1.87	3.06				
		4G-5G 1 - MetalBox	62.7	-2.03	5.78				
		4G-5G 2 - 30x30cm Ground Plane	67.5	-1.71	5.38				
		4G-5G 2 - Free Space	64.5	-1.91	3.43				
		4G-5G 2 - MetalBox	63.3	-1.99	4.69				
5GNR/4G Band 22,42,48,77,78,79	3300-5000	4G-5G 1 - 30x30cm Ground Plane	54.9	-2.61	5.10				
		4G-5G 1 - Free Space	54.6	-2.63	3.35				
		4G-5G 1 - MetalBox	52.3	-2.82	5.05				
		4G-5G 2 - 30x30cm Ground Plane	50.9	-2.93	5.32				
		4G-5G 2 - Free Space	49.9	-3.02	4.10				
		4G-5G 2 - MetalBox	46.1	-3.36	5.63				
LTE5200/Wi-Fi5800	5150-5925	4G-5G 1 - 30x30cm Ground Plane	54.8	-2.61	6.07				
		4G-5G 1 - Free Space	55.6	-2.55	5.22				
		4G-5G 1 - MetalBox	52.0	-2.84	6.38				
		4G-5G 2 - 30x30cm Ground Plane	54.4	-2.65	6.09				
		4G-5G 2 - Free Space	53.1	-2.75	4.85				
		4G-5G 2 - MetalBox	50.0	-3.01	6.03				

Mechanical	
Dimensions	Ø59.45mm x 70mm
Weight	130g
Material	ASA
Connector	SMA(M) ST
Cable	LTE: 1m of TGC-1.5DS

Environmental	
Waterproof Rating	IP67
Operation Temperature	-40°C - +85°C
Storage Temperature	-40°C - +85°C
RoHs & REACH Compliant	Yes

3. Mechanical Drawing

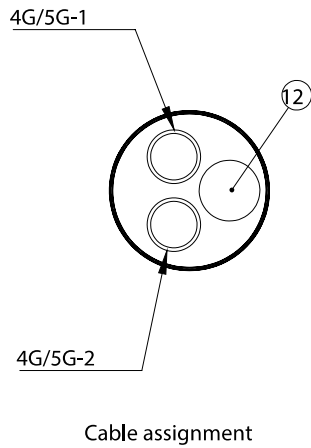

	Name	Material	Finish	Qty
1	Top housing	ASA	White, MT9050	1
2	Bottom housing	ASA	Black	1
3	Grommet	Silicone Rubber	Black	1
4	Multi Tooth Washer	Iron	Ni Plated	1
5	Nut M12_Cut	Brass	Ni Plated	1
6	Heat Shrink Tube(4G/5G-1)	PE	Red Tube/White Text	1
7	Heat Shrink Tube(4G/5G-2)	PE	Red Tube/White Text	1
8	SMA(M)ST Plug for low loss 1.5DS	Brass	Au Plated	2
9	TGC-1.5DS Coaxial Cable	XLPE	Black	1
10	Double Sided Adhesive	E4308+3M 9448HK	Black foam/white liner	1
11	CE,WEEE and UKCA mark logo Label	PEPA	White	1
12	Grommet plug_RG174	ASA	Black	1

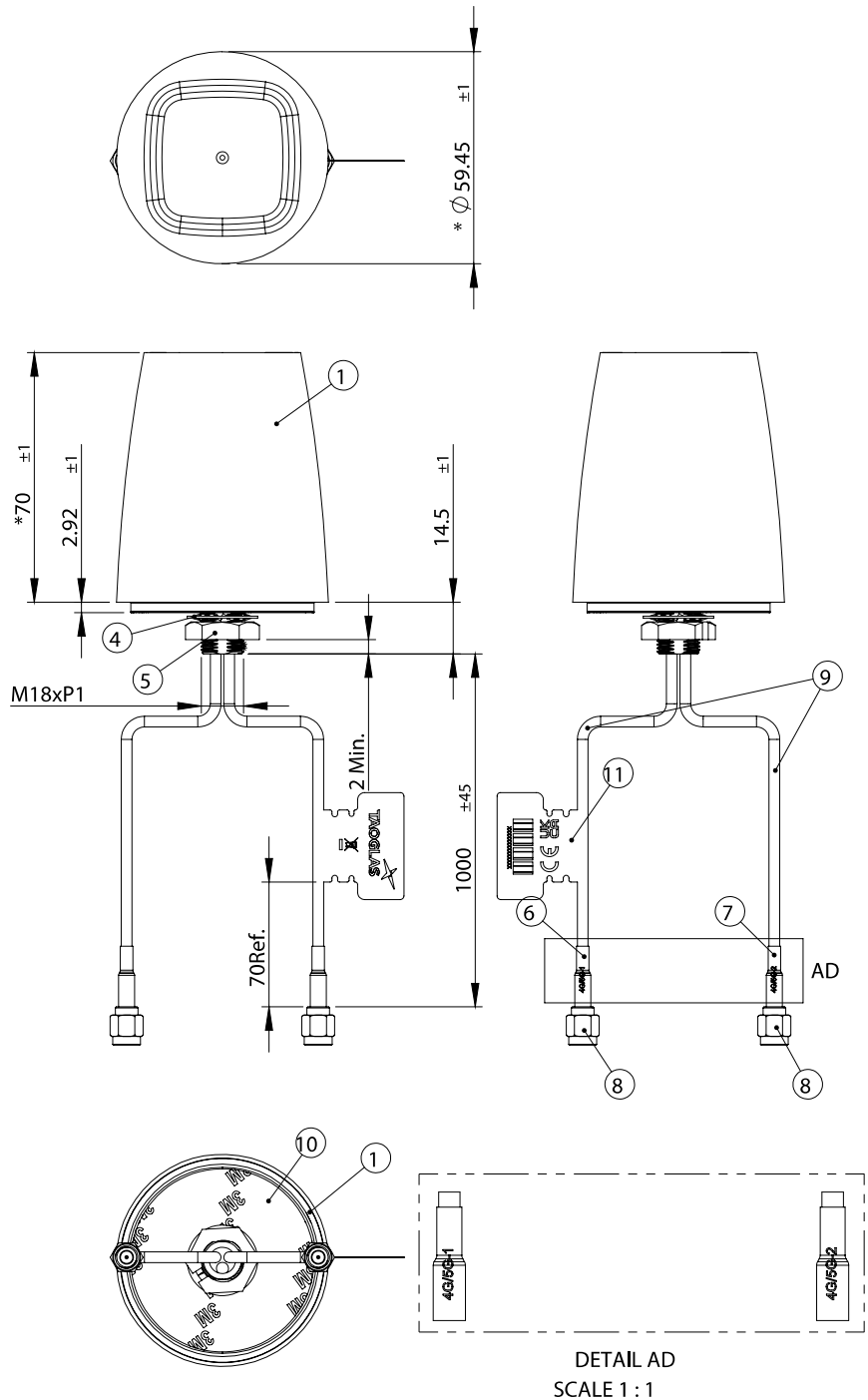

4. Packaging

1pc MA182 per PE Bag
Weight: 130g

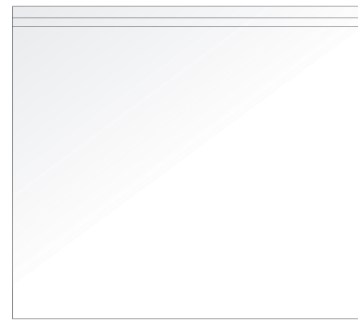

60pcs MA182 per Carton
Carton Dimensions: 430x380x280mm
Weight: 8.9Kg

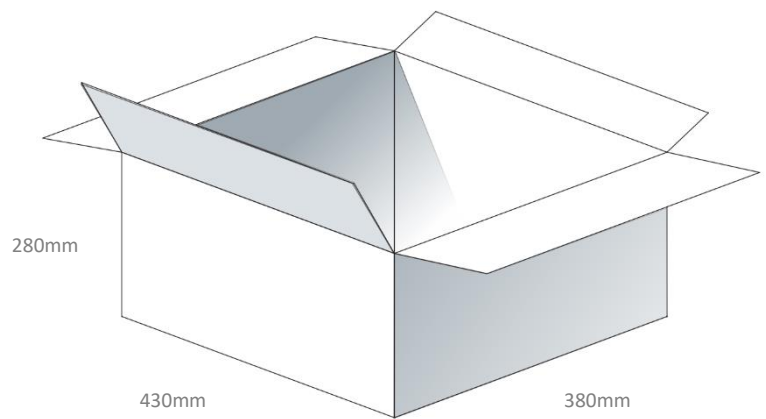

5. Antenna Characteristics

5.1 Test Setup

AUT



Vector Network Analyzer

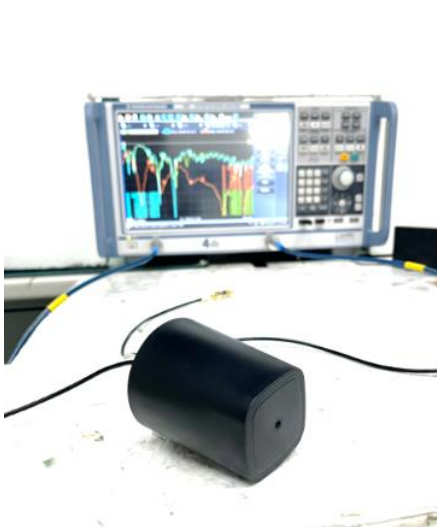

Free Space

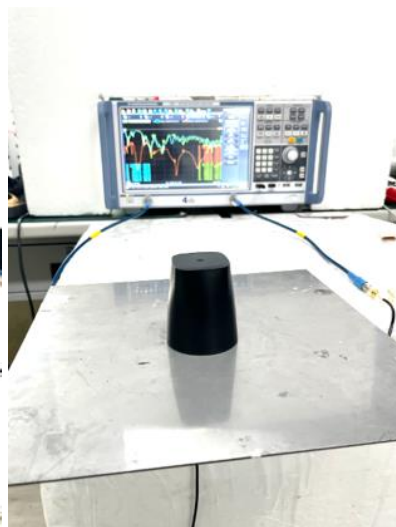

30x30cm Metal Ground Plane



Metal Box

5.1 4G-5G - Return Loss

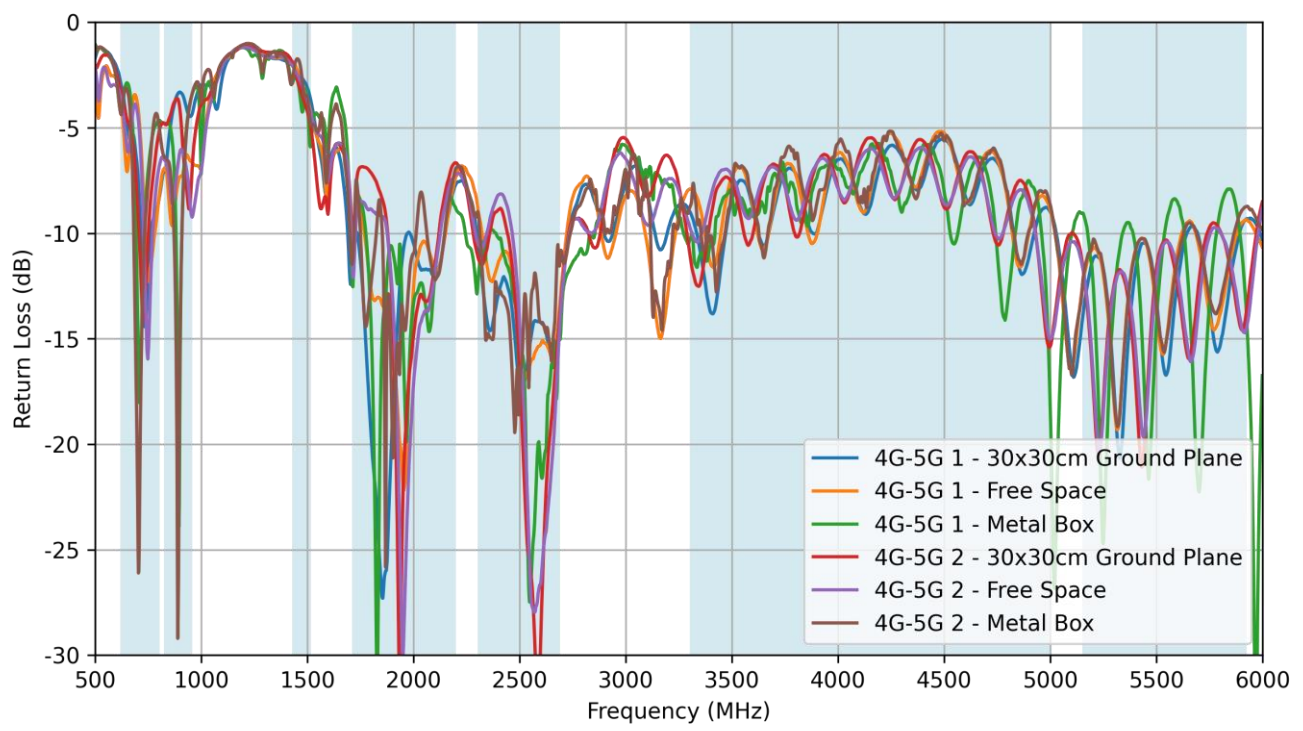

5.2 4G-5G - VSWR

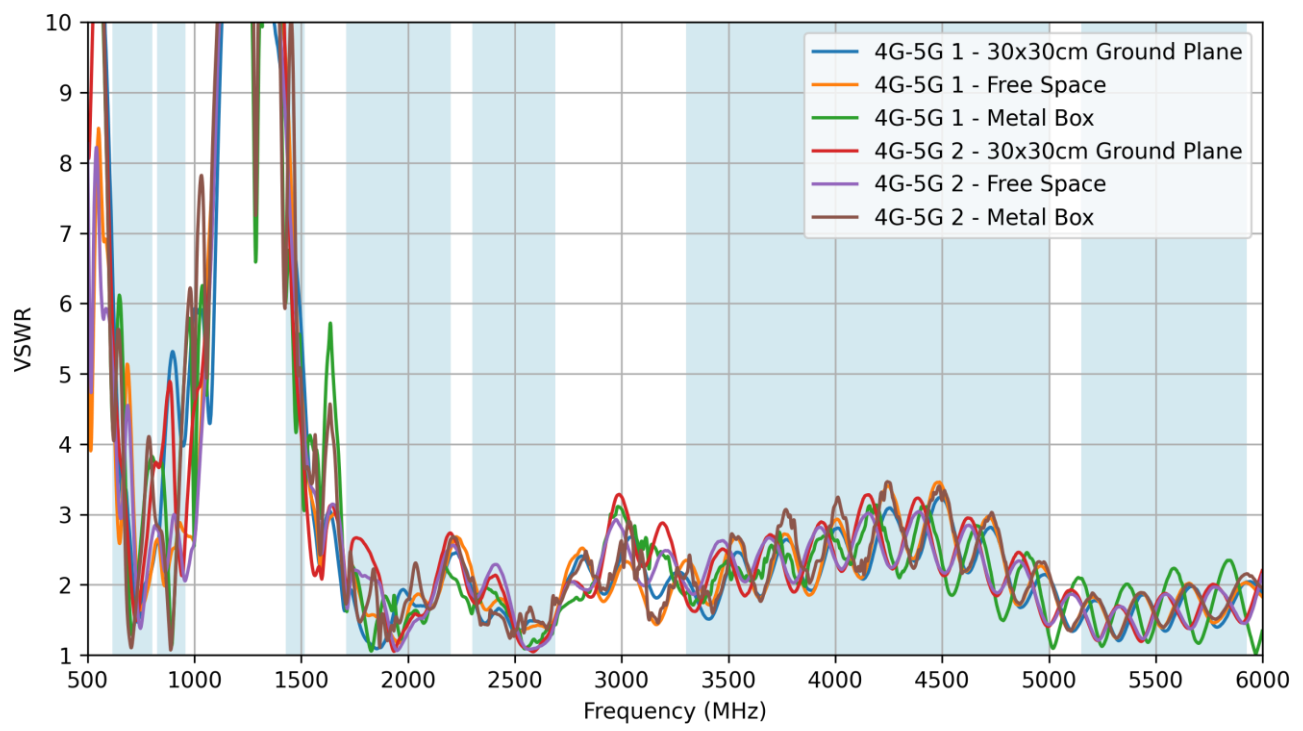

5.3 Isolation

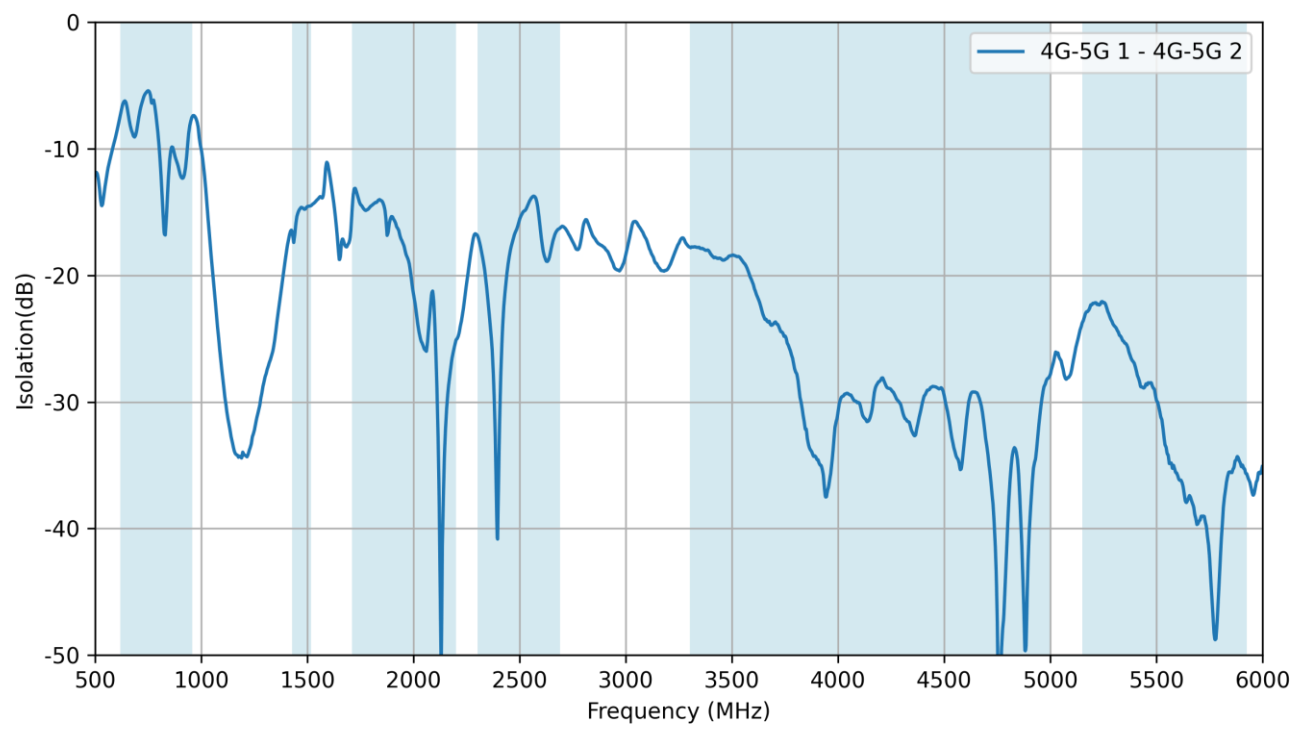

5.4 4G-5G - Efficiency

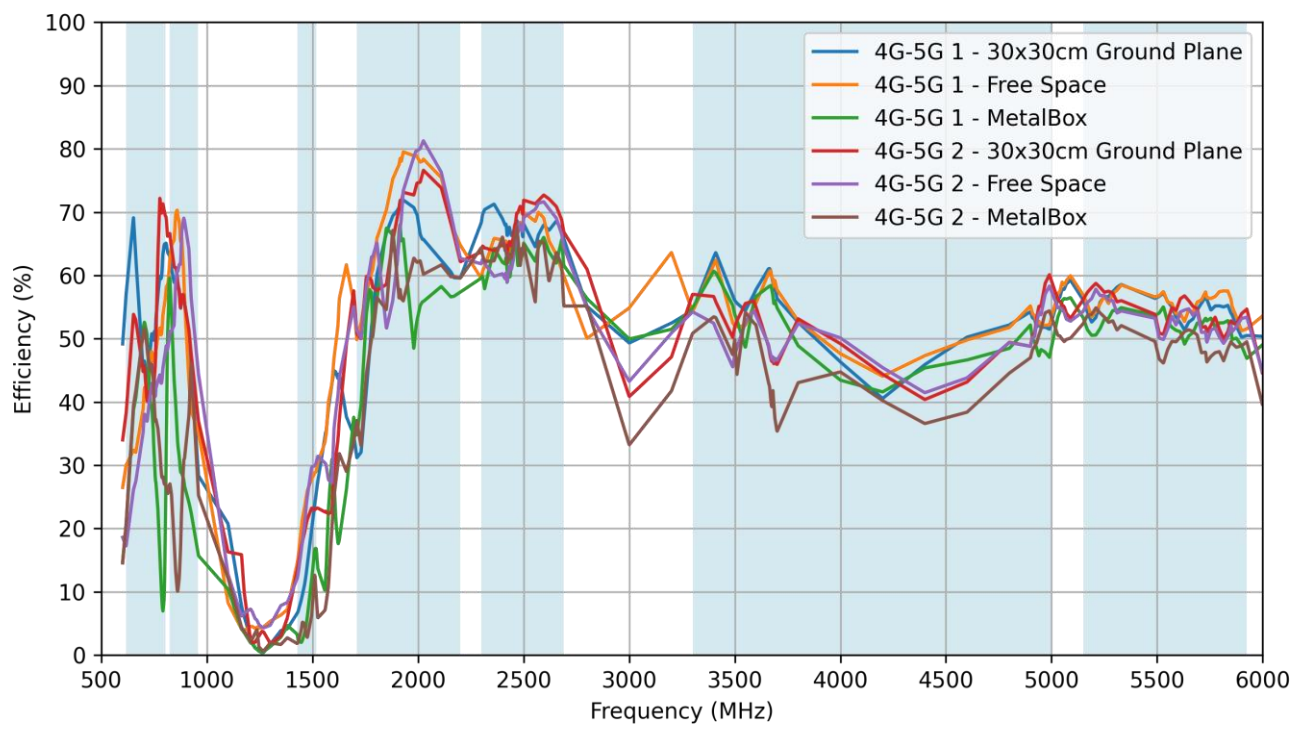

5.5 4G-5G - Average Gain

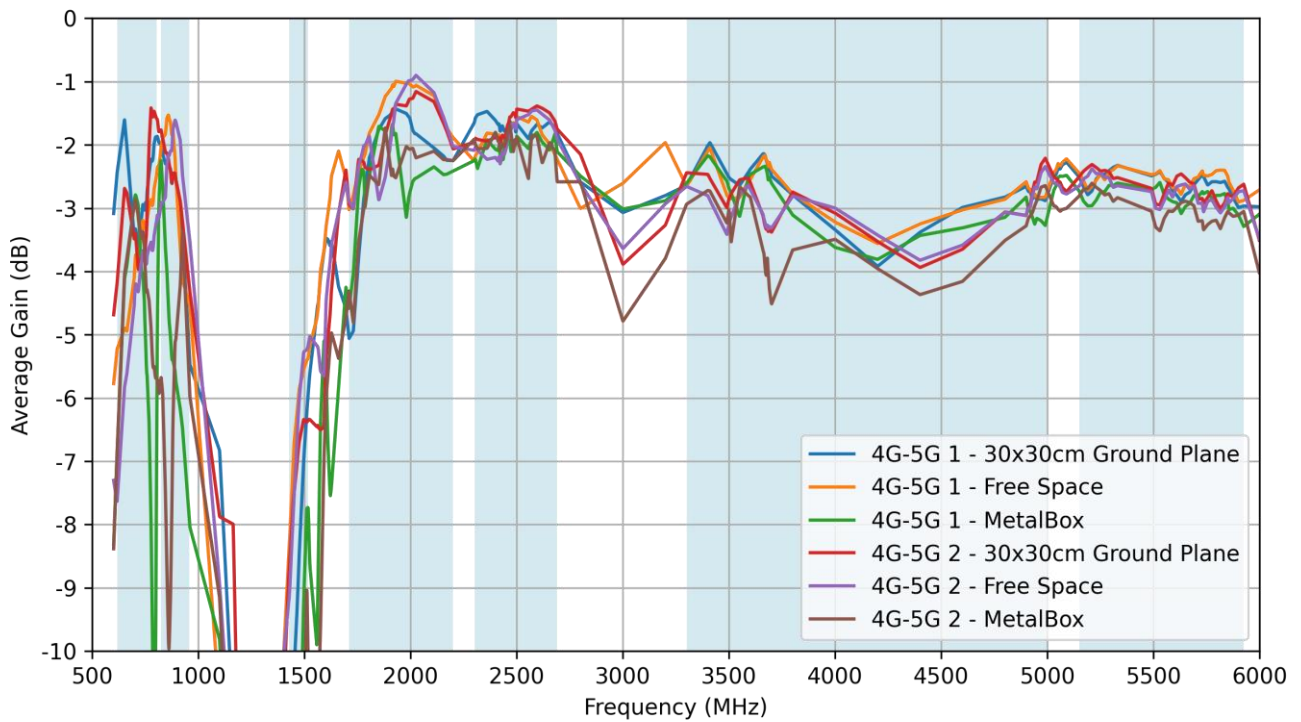

5.6 4G-5G - Peak Gain

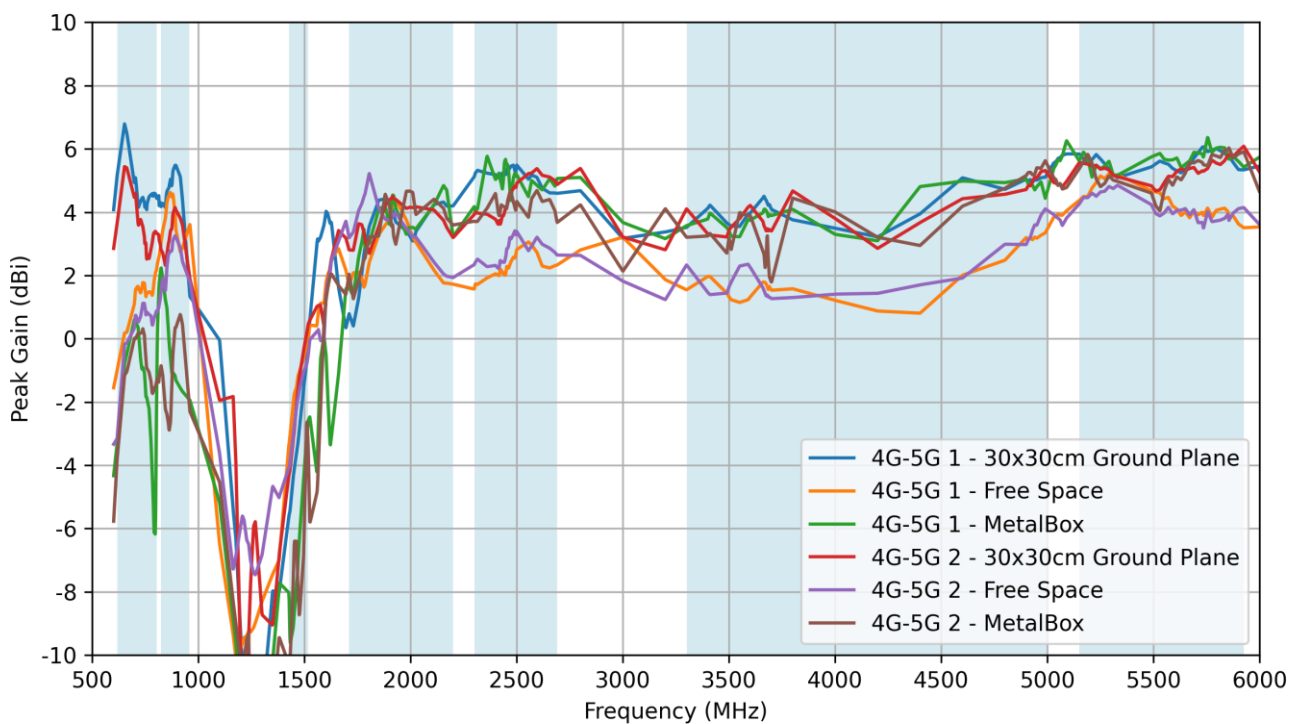

6. Radiation Patterns

6.1 Test Setup

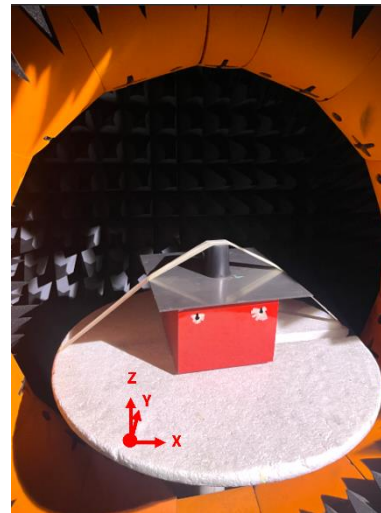
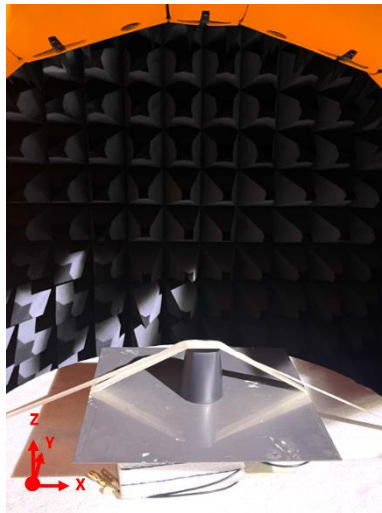
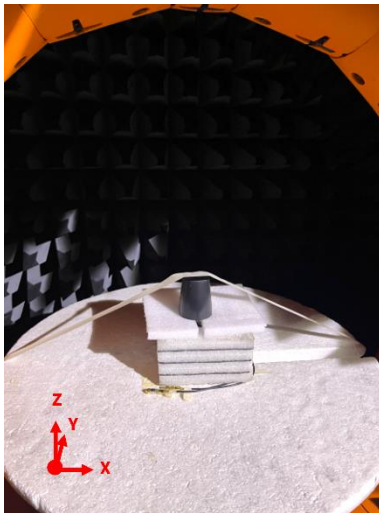
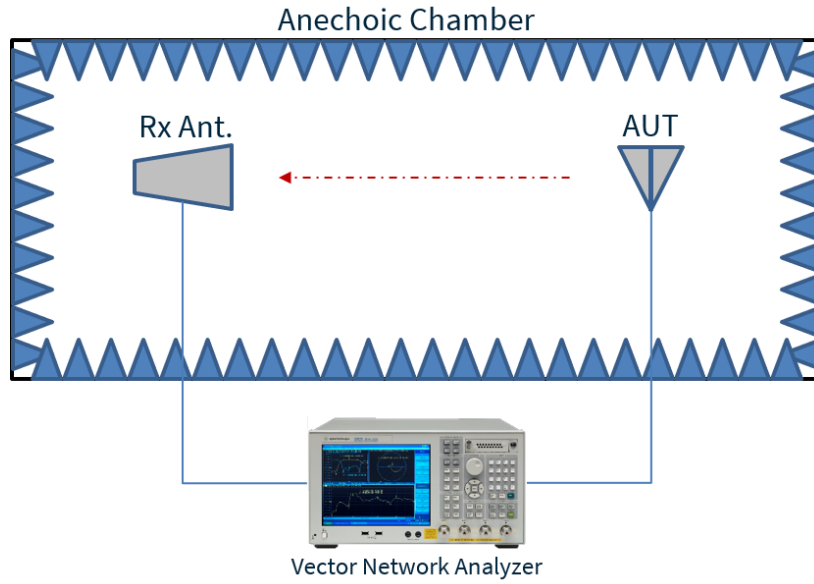

6.2 4G-5G 1 - 30x30cm Ground Plane Patterns at 652 MHz

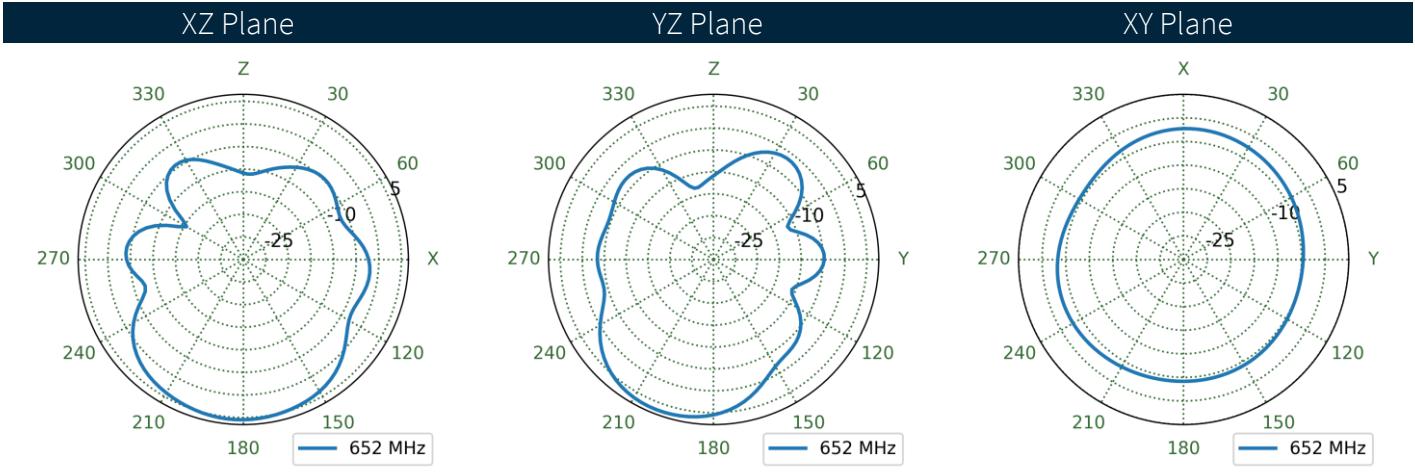
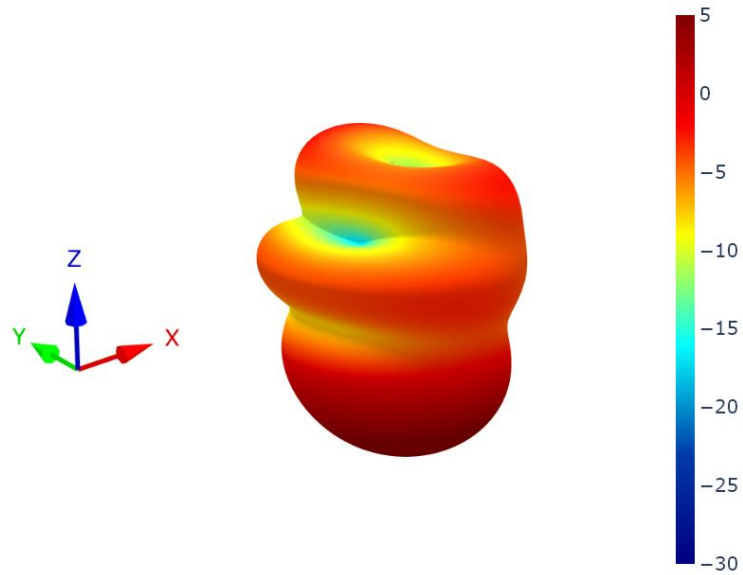

6.3 4G-5G 1 - Free Space Patterns at 652 MHz

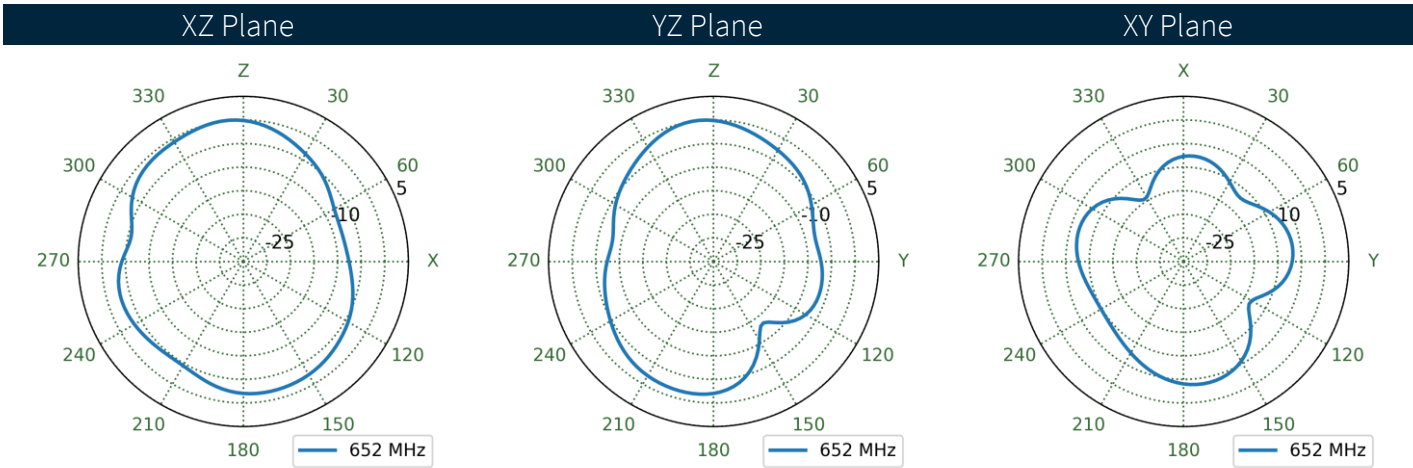
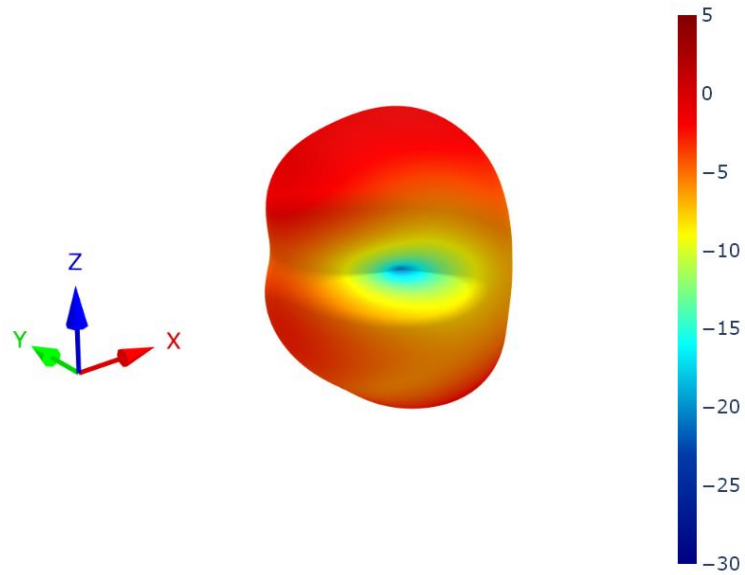

6.4 4G-5G 1 – Metal Box Patterns at 652 MHz

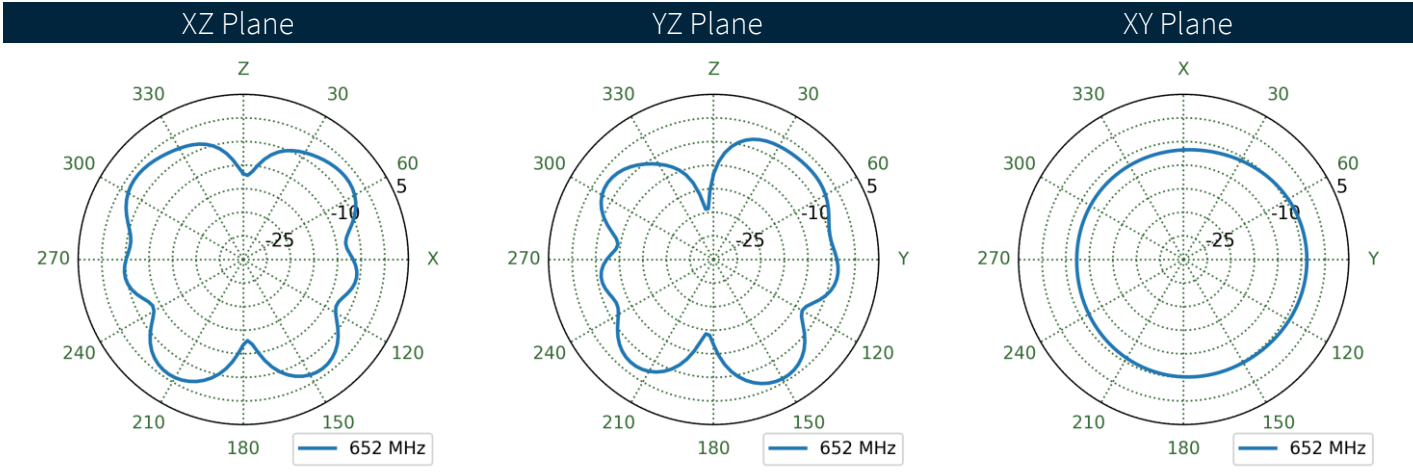
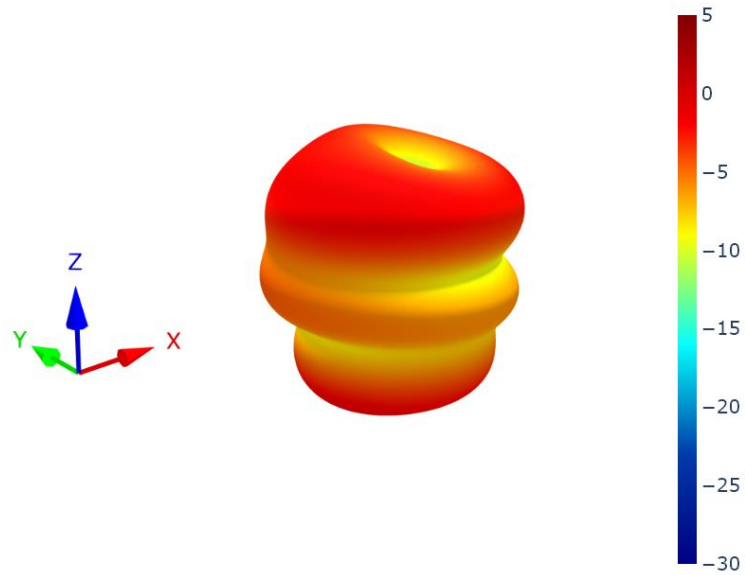

6.5 4G-5G 2 - 30x30cm Ground Plane Patterns at 652 MHz

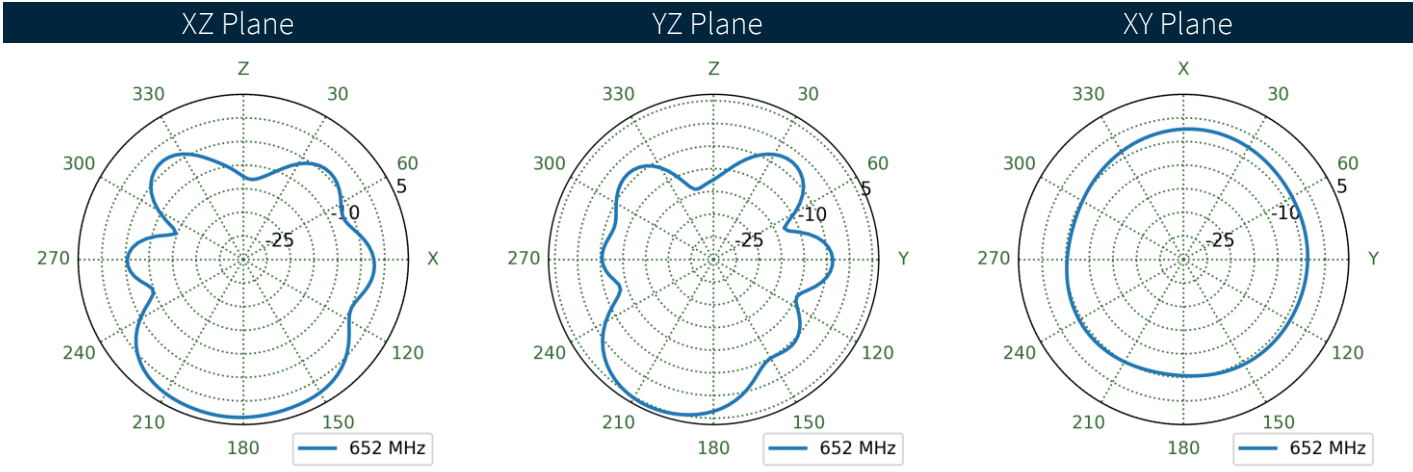
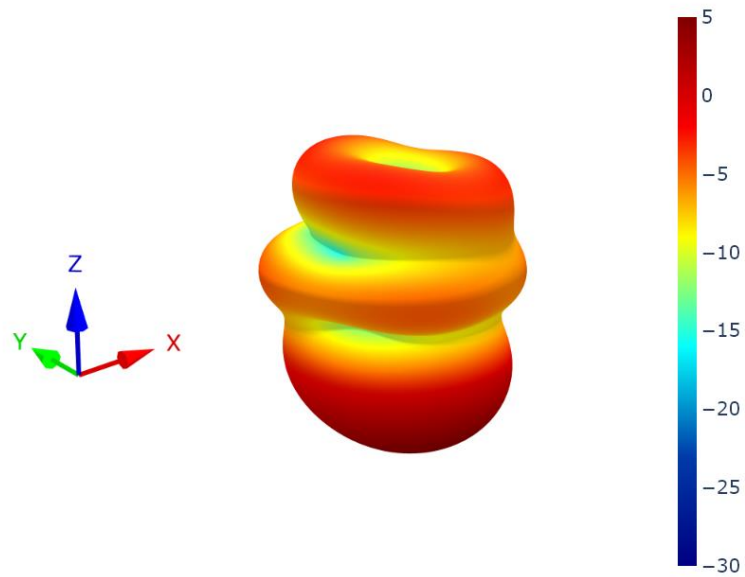

6.6 4G-5G 2 - Free Space Patterns at 652 MHz

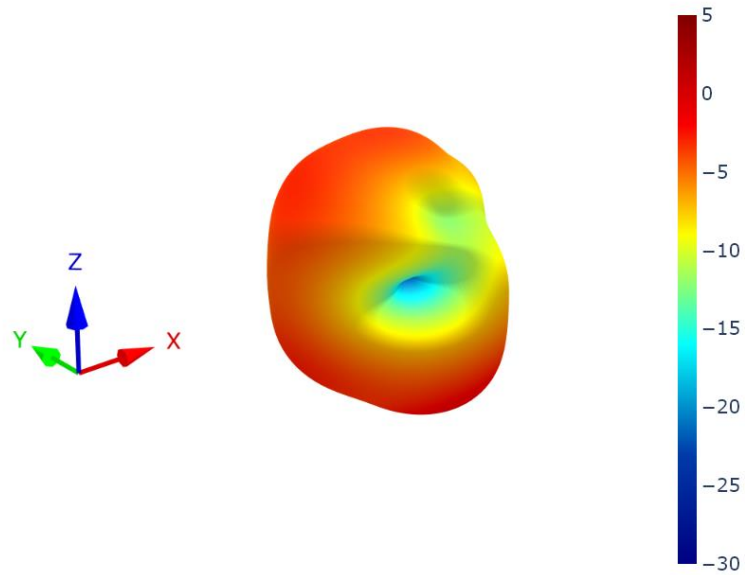

XZ Plane YZ Plane XY Plane

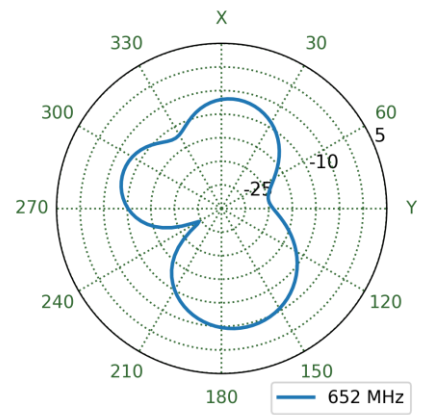
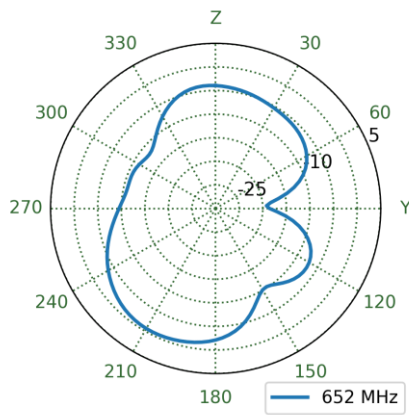
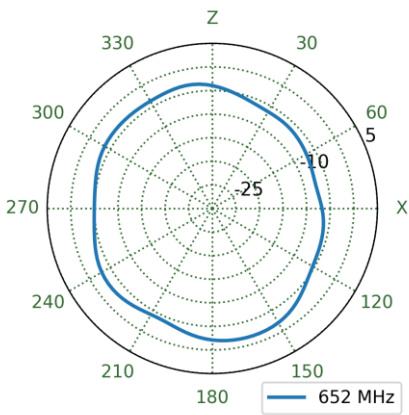

6.7 4G-5G 2 – Metal Box Patterns at 652 MHz

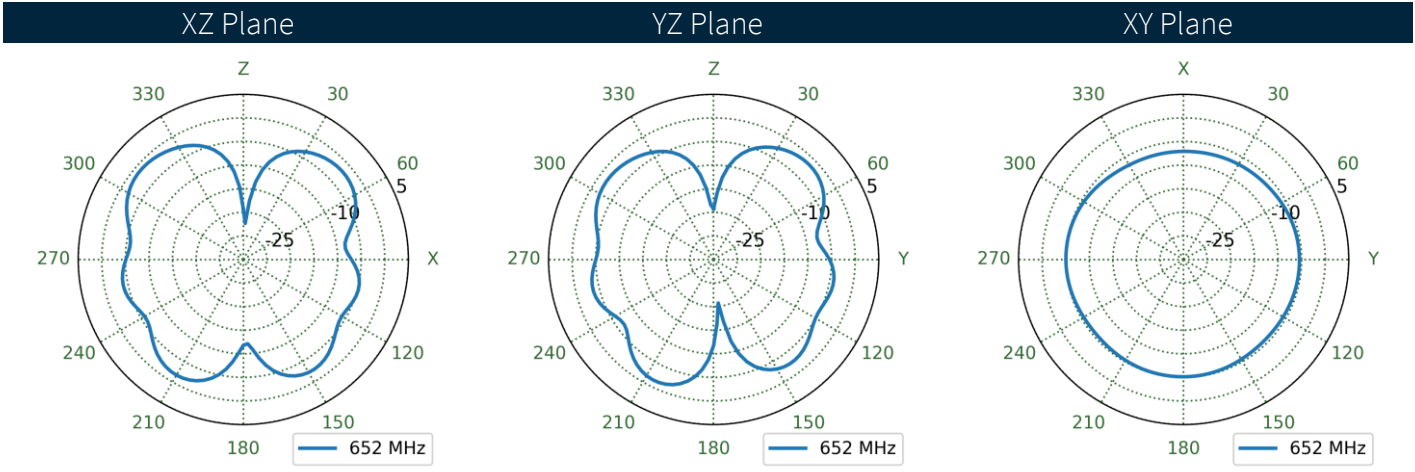
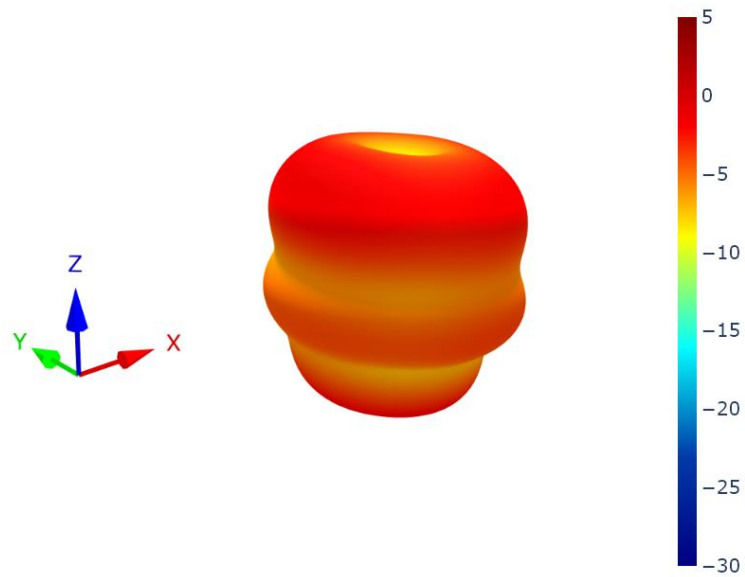

6.8 4G-5G 1 - 30x30cm Ground Plane Patterns at 751 MHz

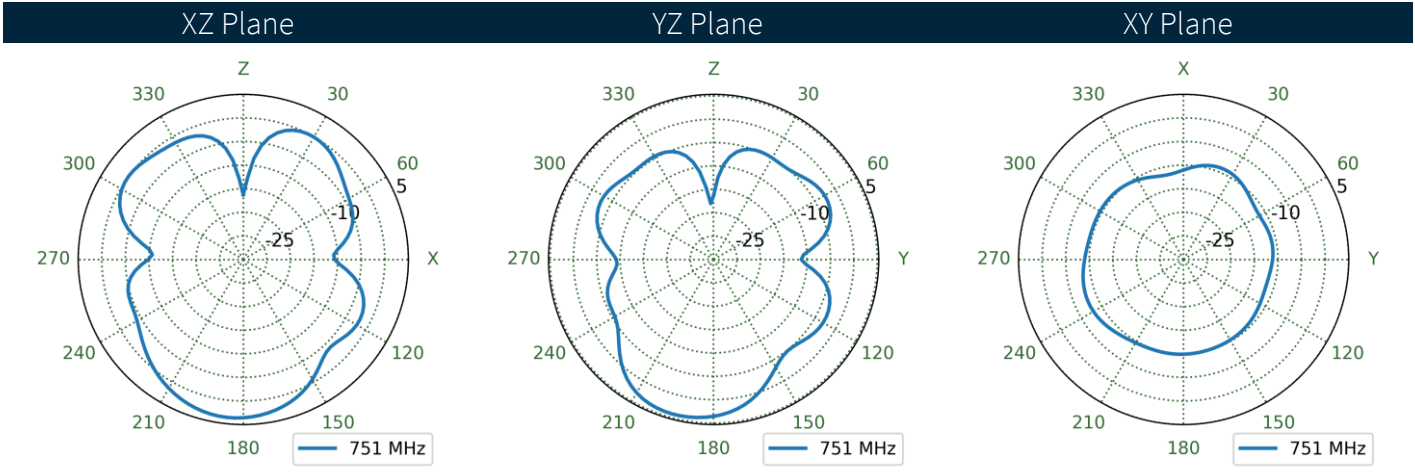
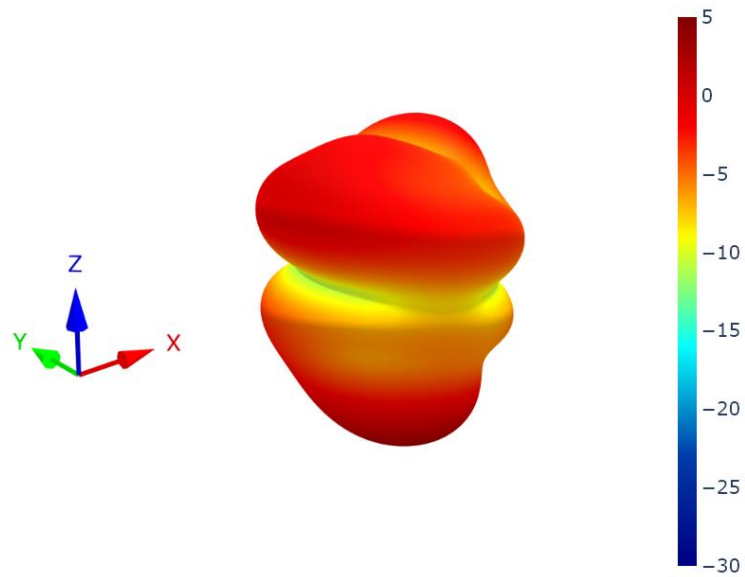

6.9 4G-5G 1 - Free Space Patterns at 751 MHz

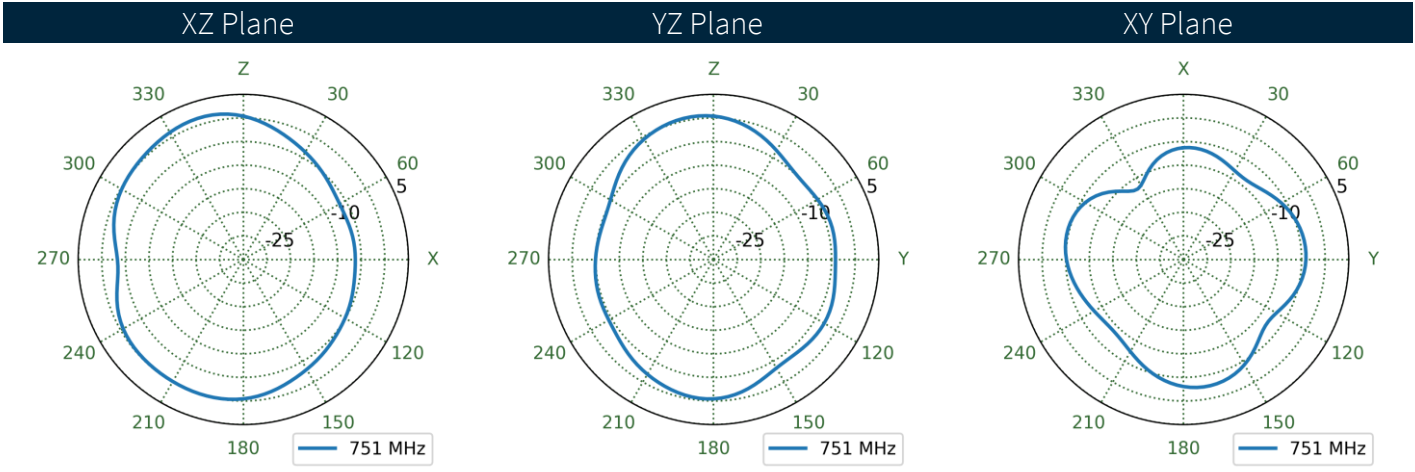
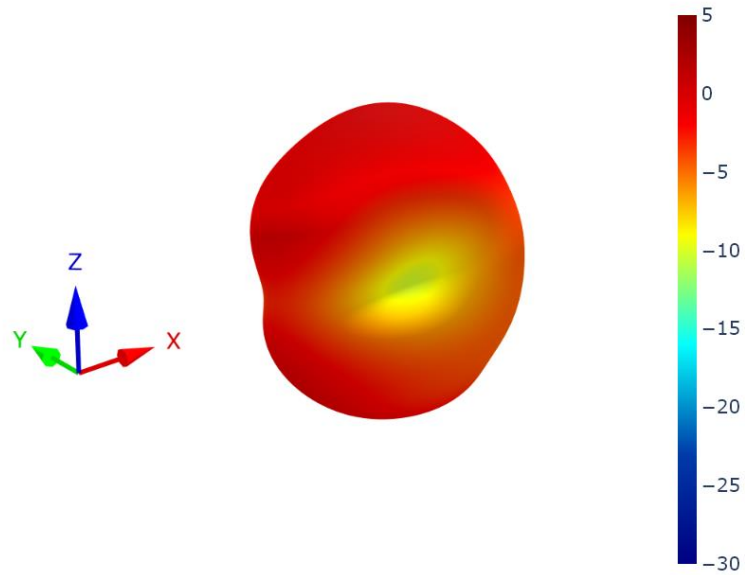

6.10 4G-5G 1 - Metal Box Patterns at 751 MHz

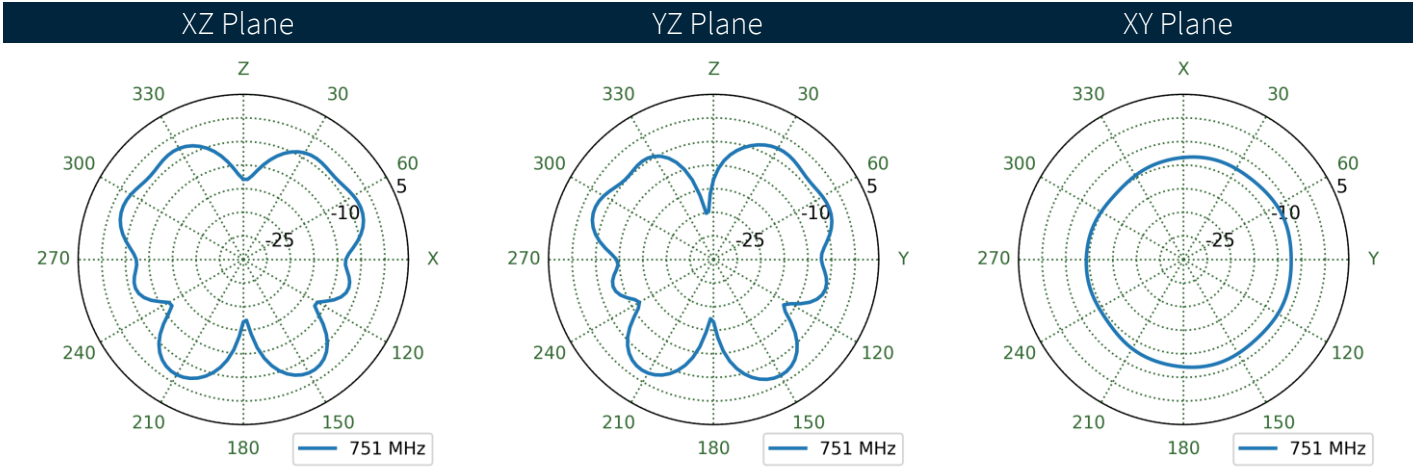
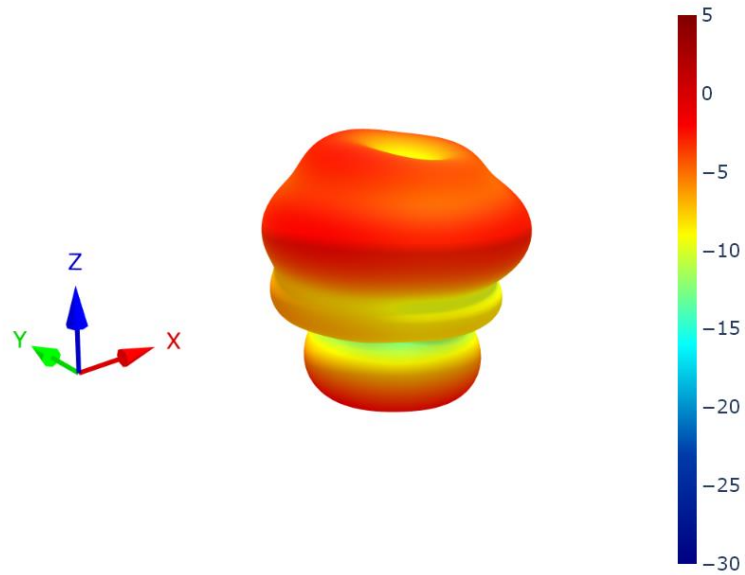

6.11 4G-5G 2 - 30x30cm Ground Plane Patterns at 751 MHz

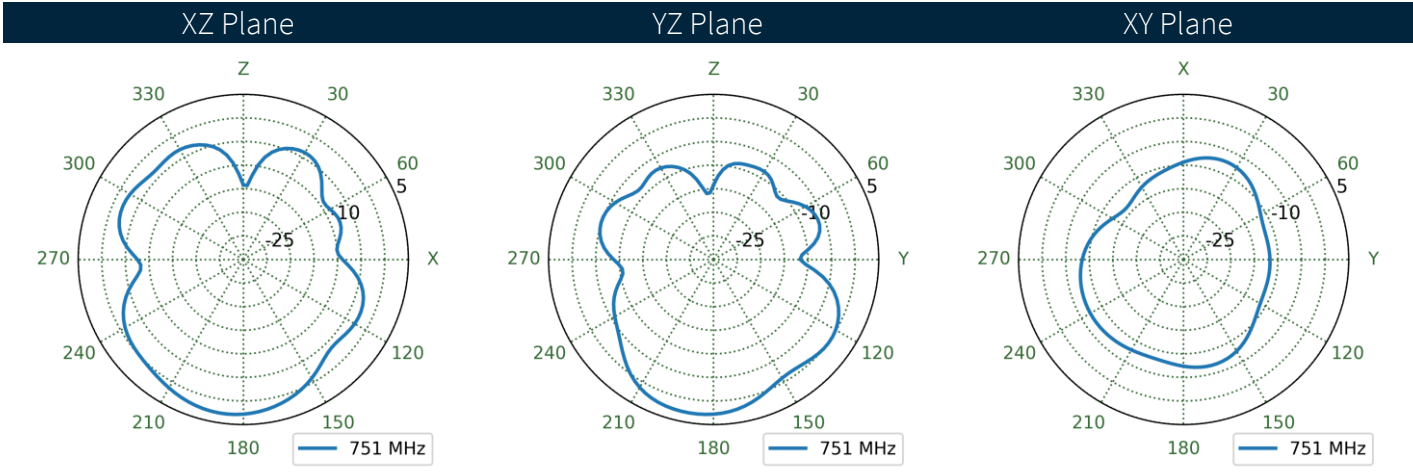
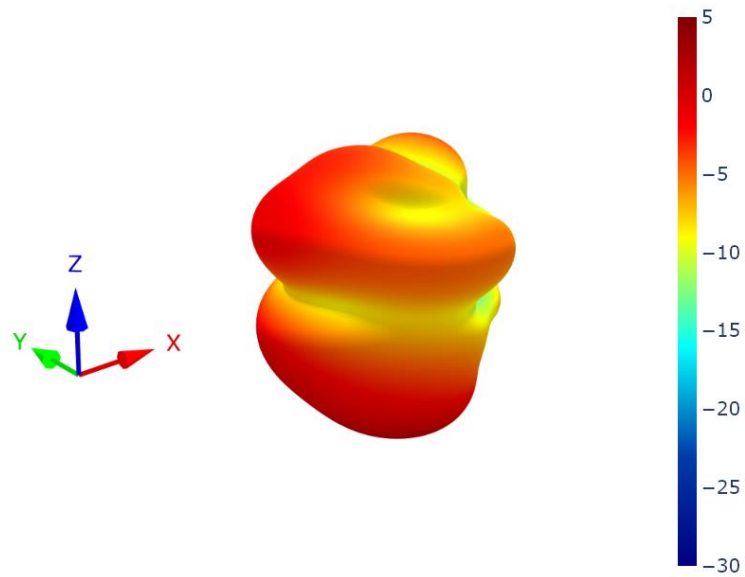

6.12 4G-5G 2 - Free Space Patterns at 751 MHz

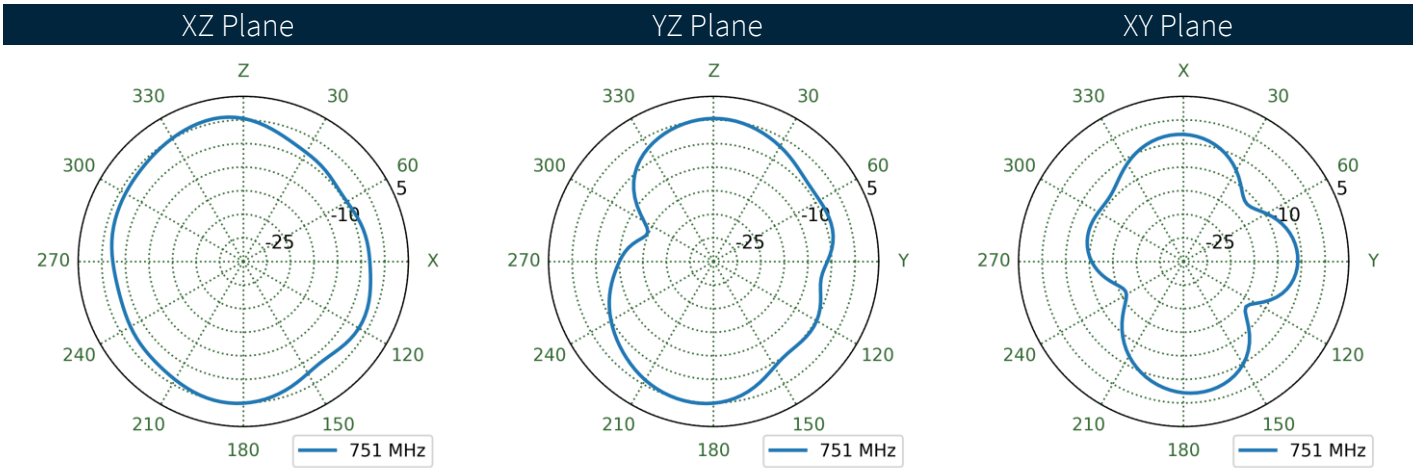
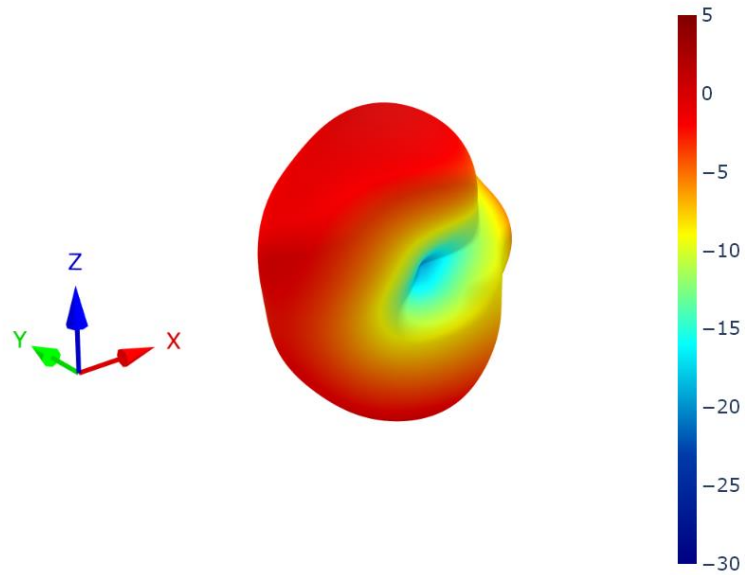

6.13 4G-5G 2 - Metal Box Patterns at 751 MHz

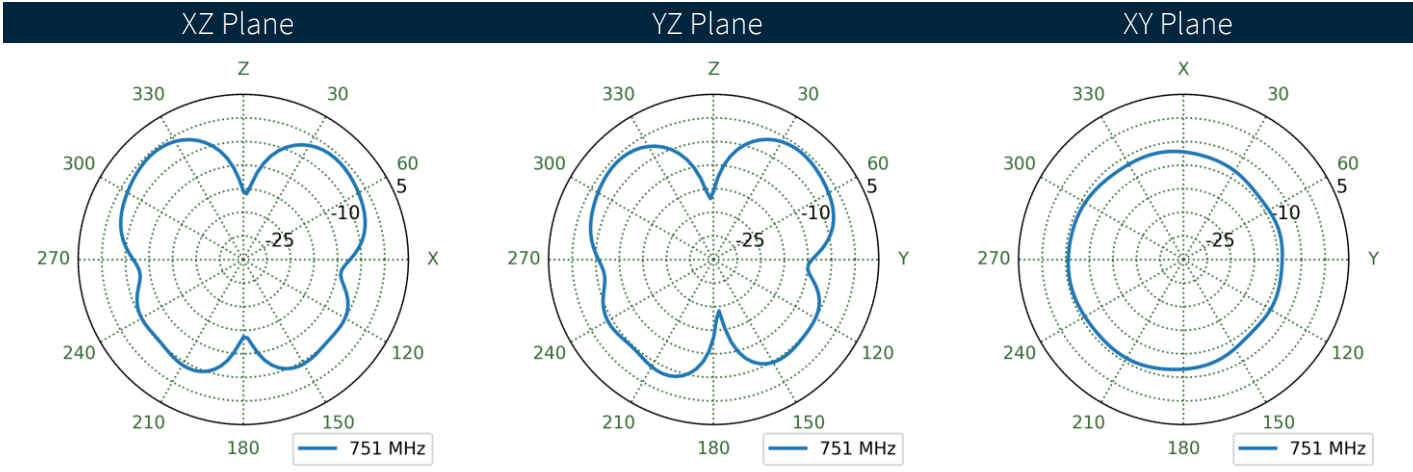
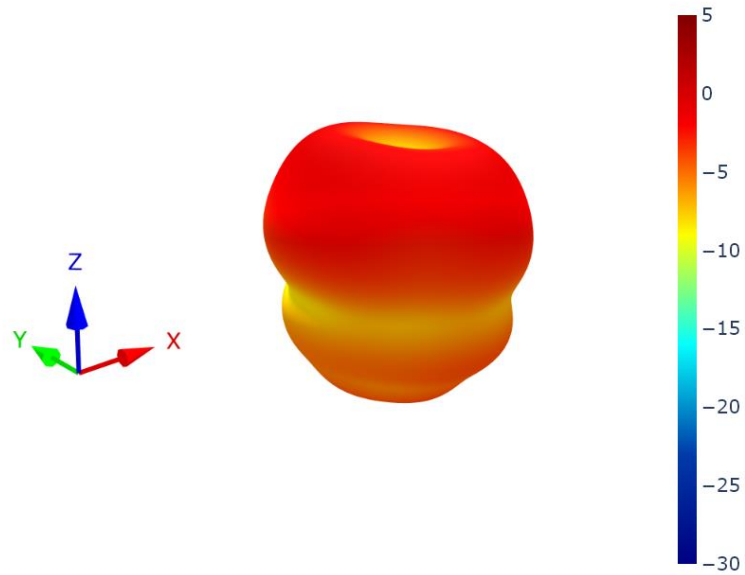

6.14 4G-5G 1 - 30x30cm Ground Plane Patterns at 892 MHz

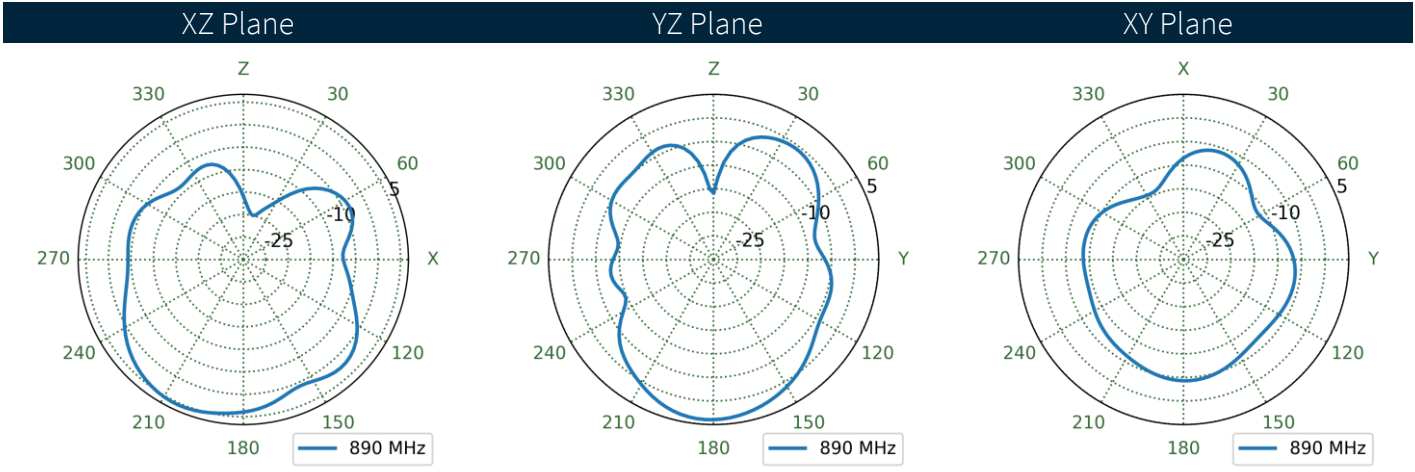
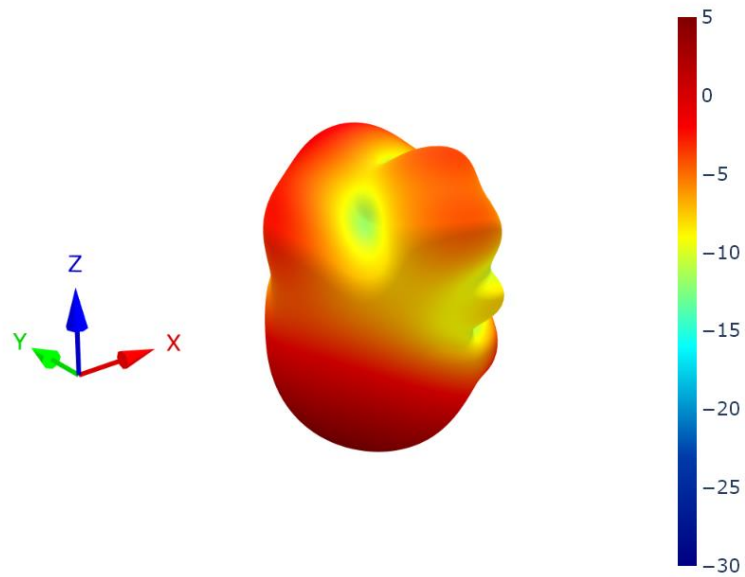

6.15 4G-5G 1 - Free Space Patterns at 892 MHz

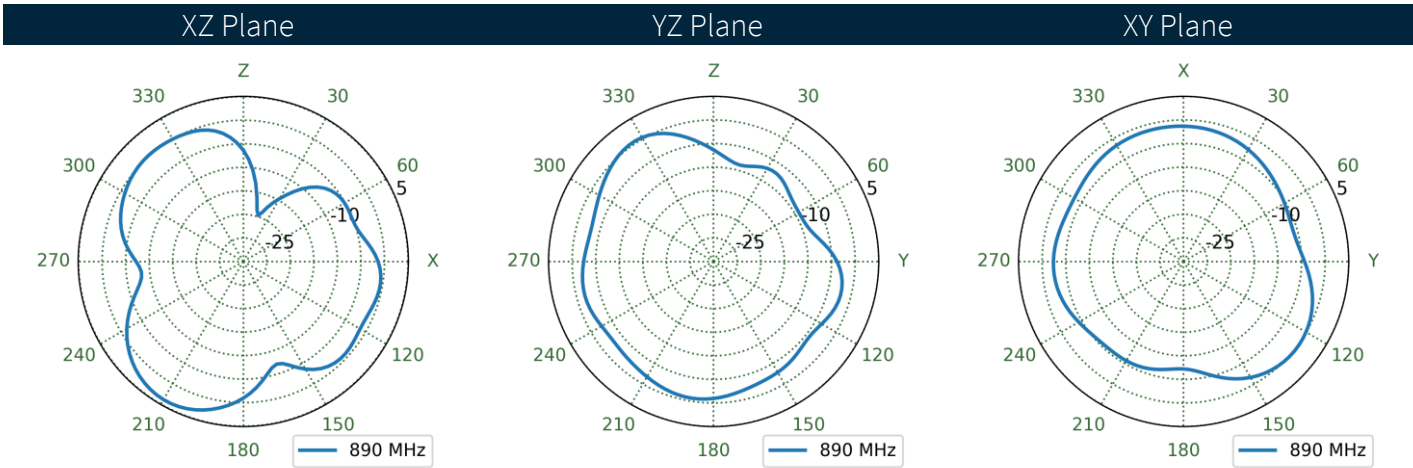
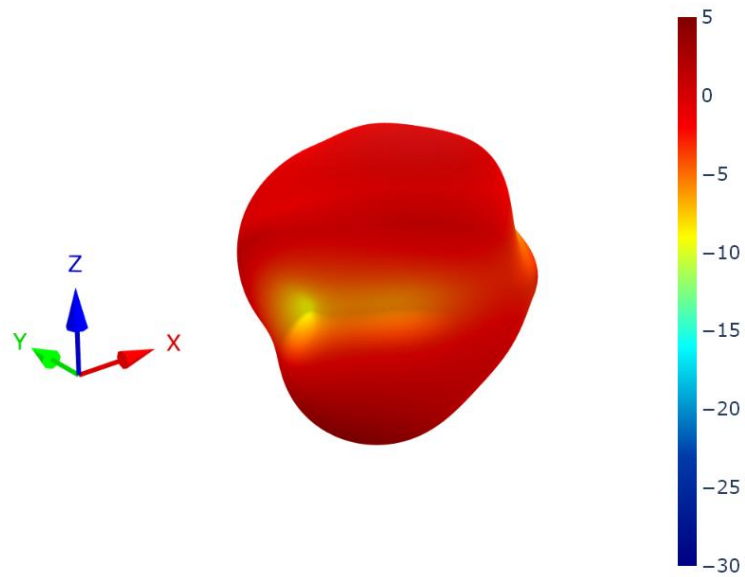

6.16 4G-5G 1 - Metal Box Patterns at 892 MHz

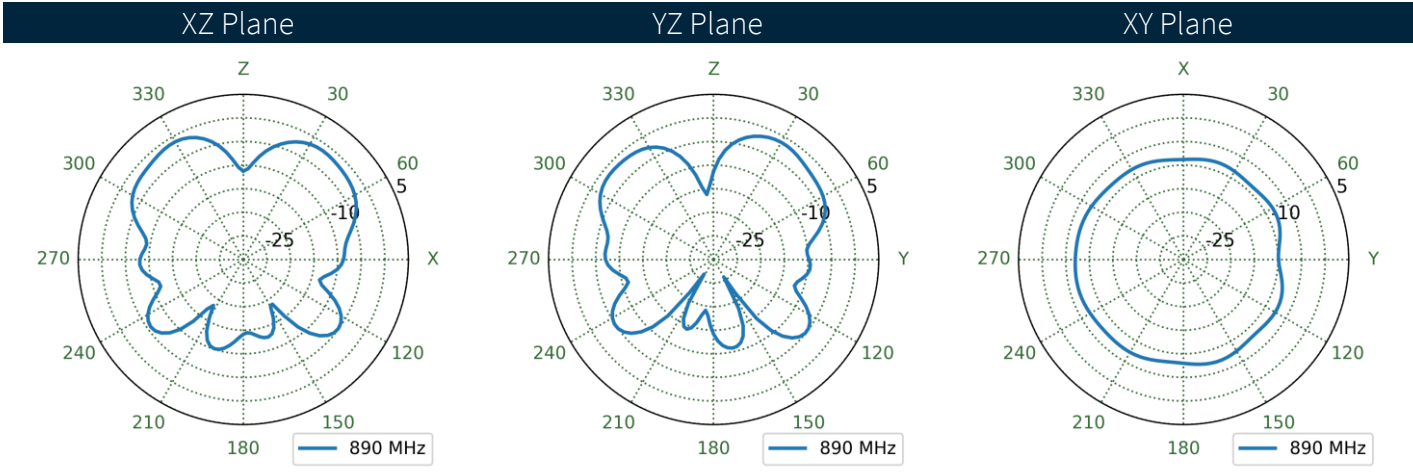
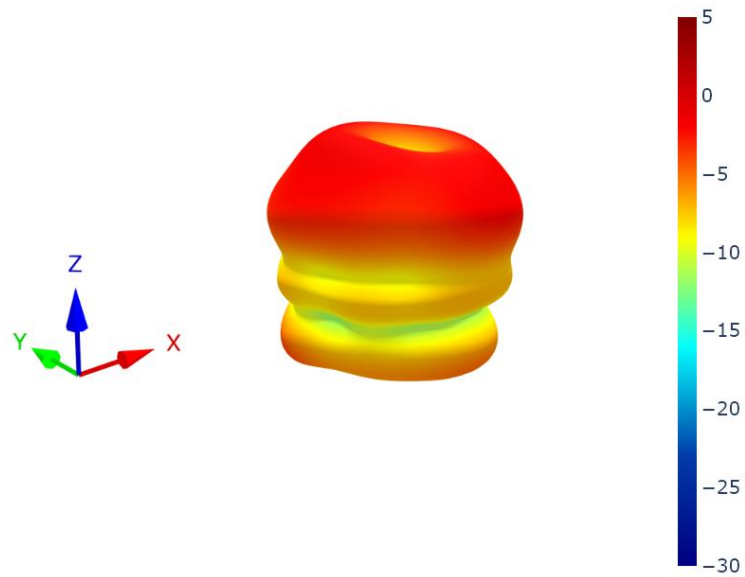

6.17 4G-5G 2 - 30x30cm Ground Plane Patterns at 892 MHz

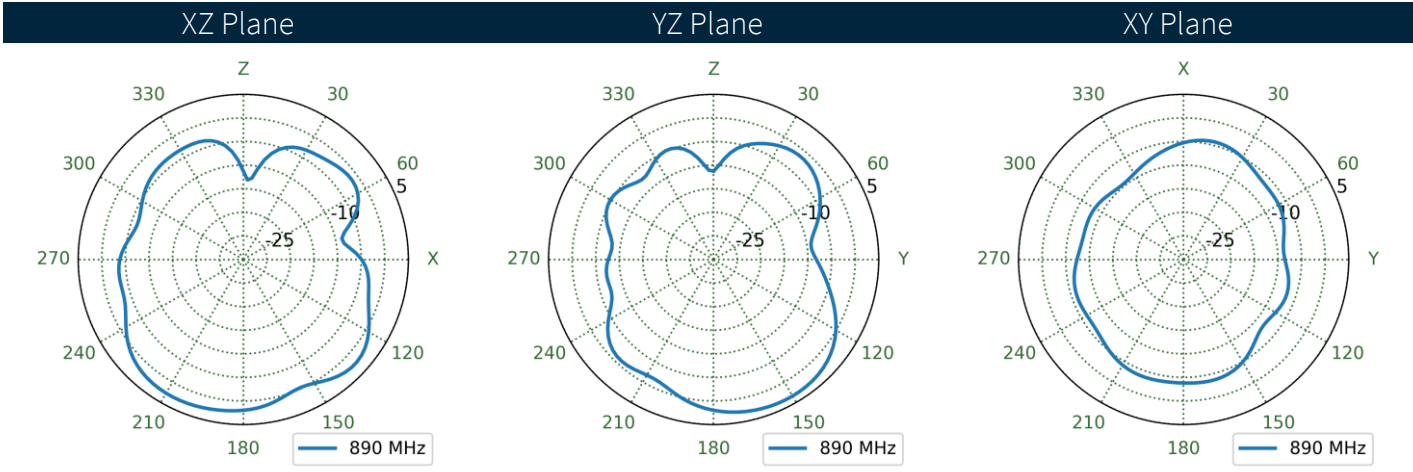
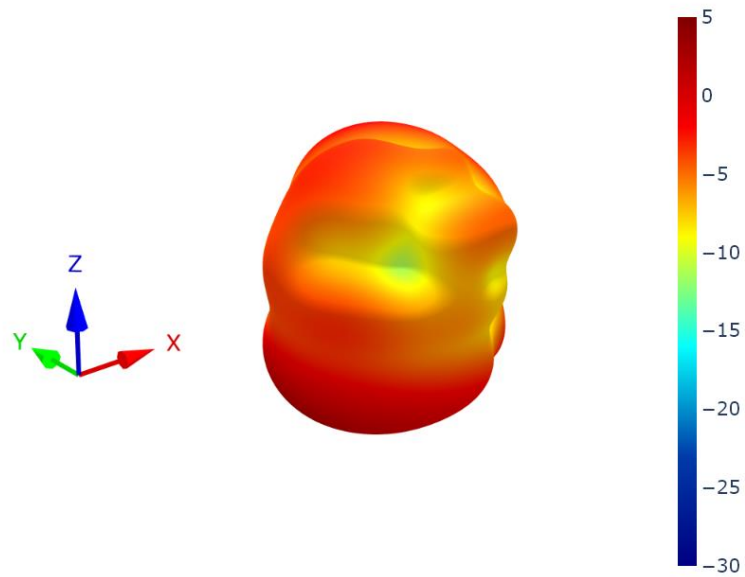

6.18 4G-5G 2 - Free Space Patterns at 892 MHz

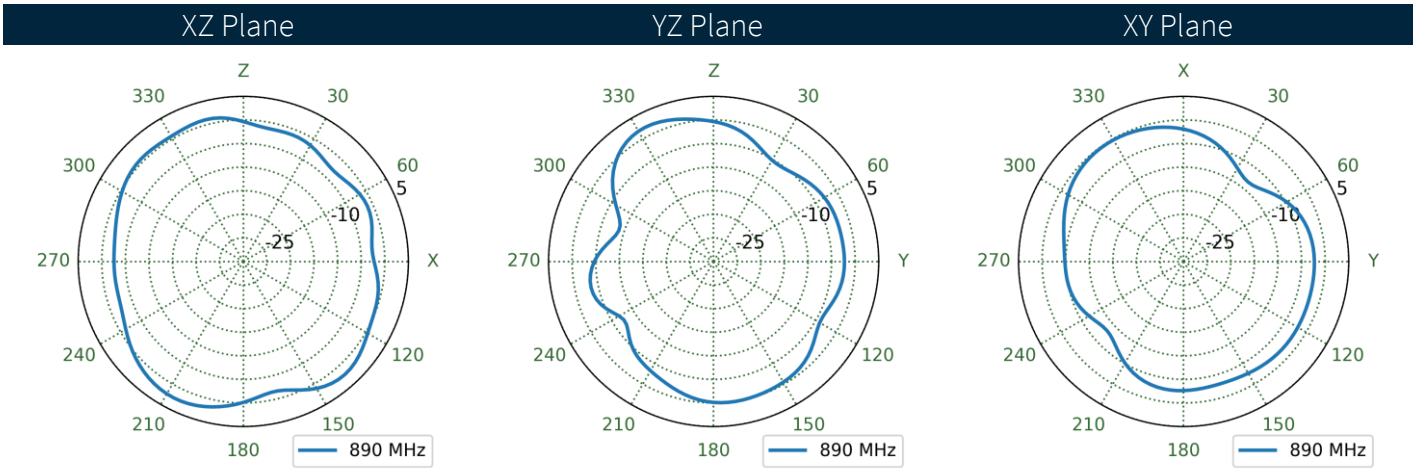
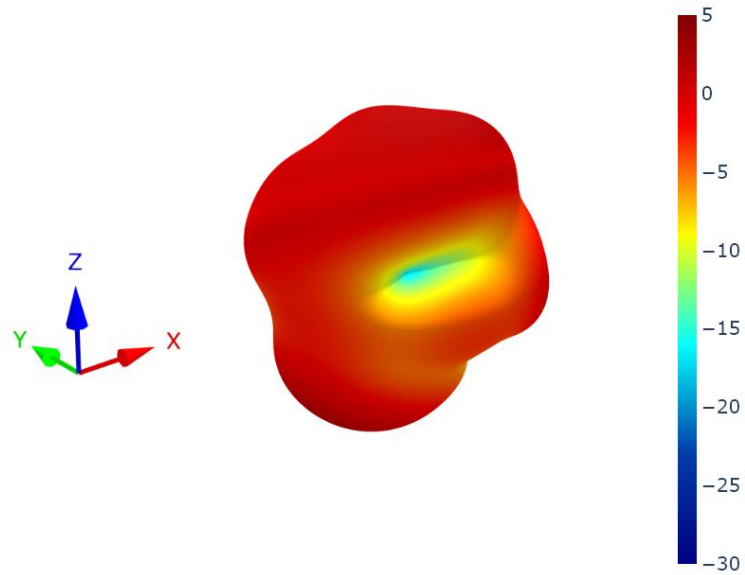

6.19 4G-5G 2 - Metal Box Patterns at 892 MHz

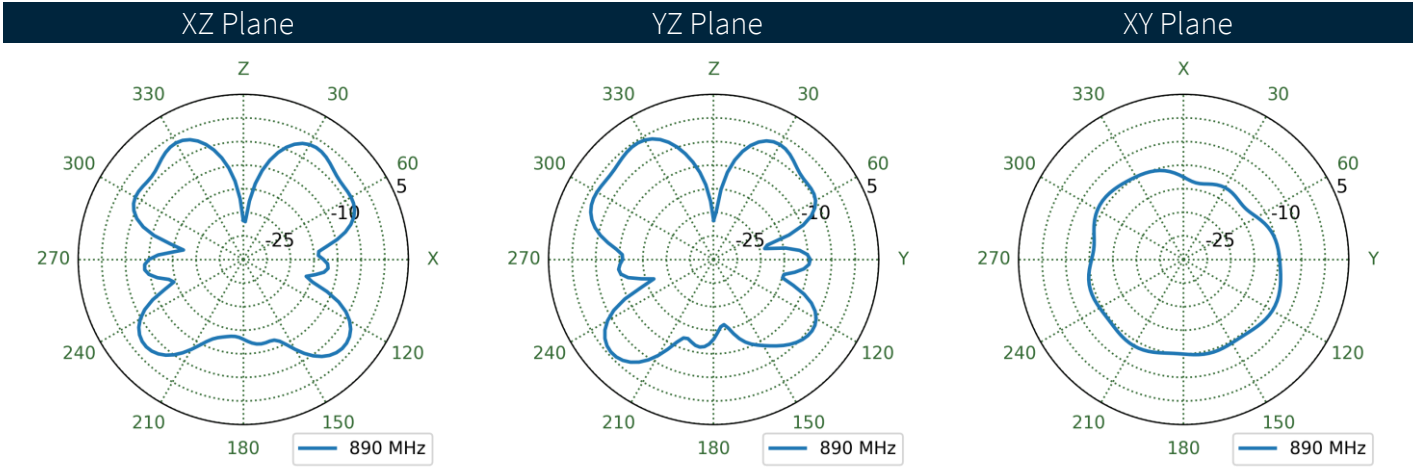
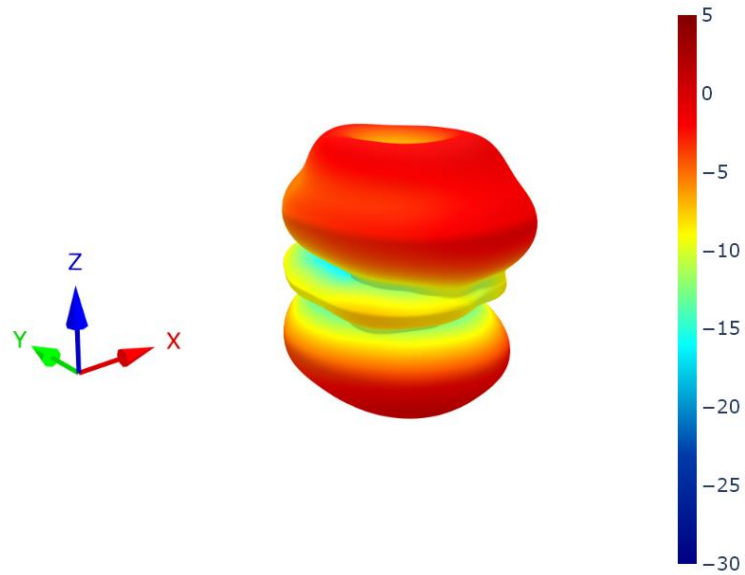

6.20 4G-5G 1 - 30x30cm Ground Plane Patterns at 1470 MHz

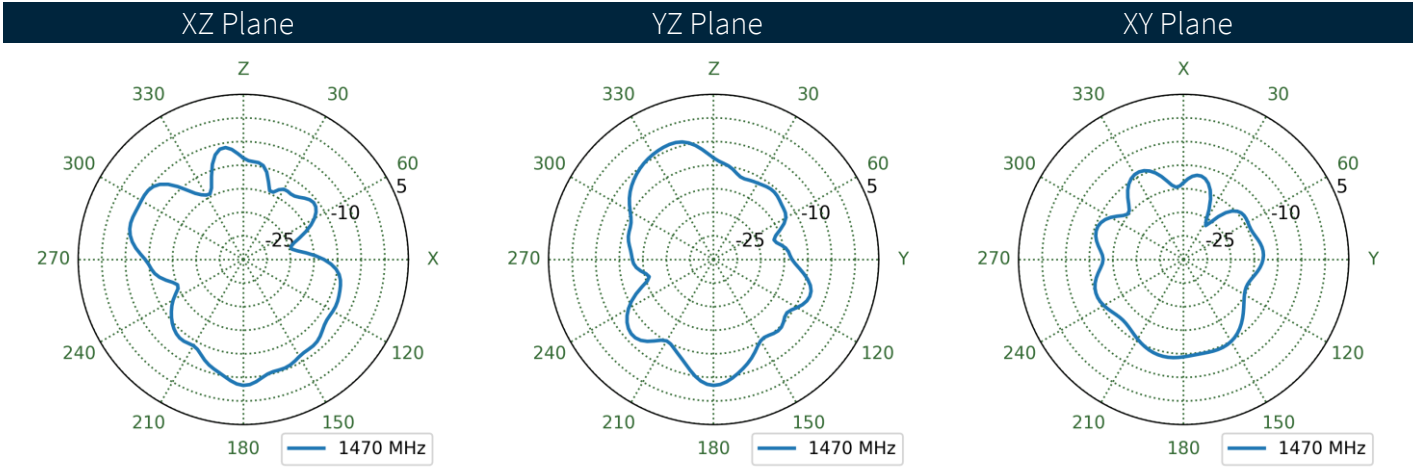
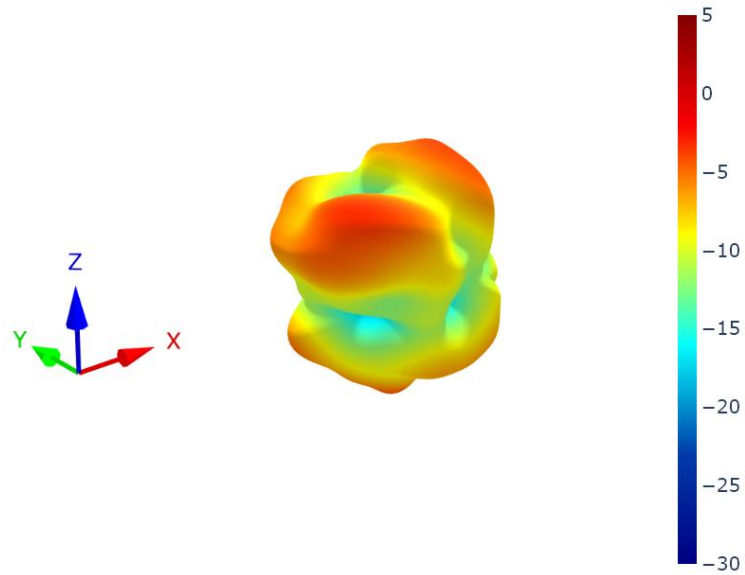

6.21 4G-5G 1 - Free Space Patterns at 1470 MHz

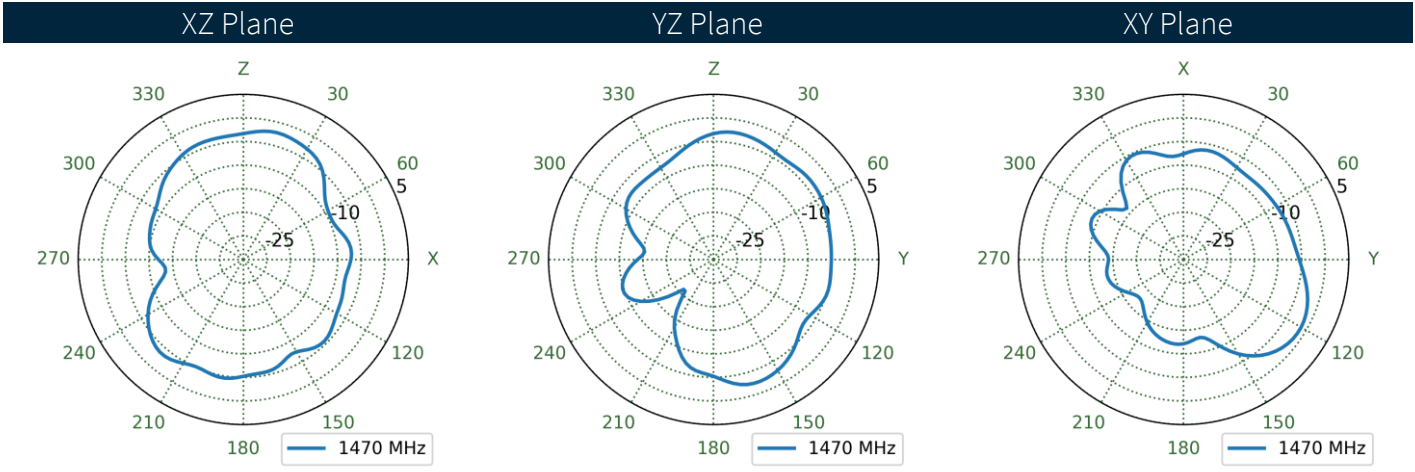
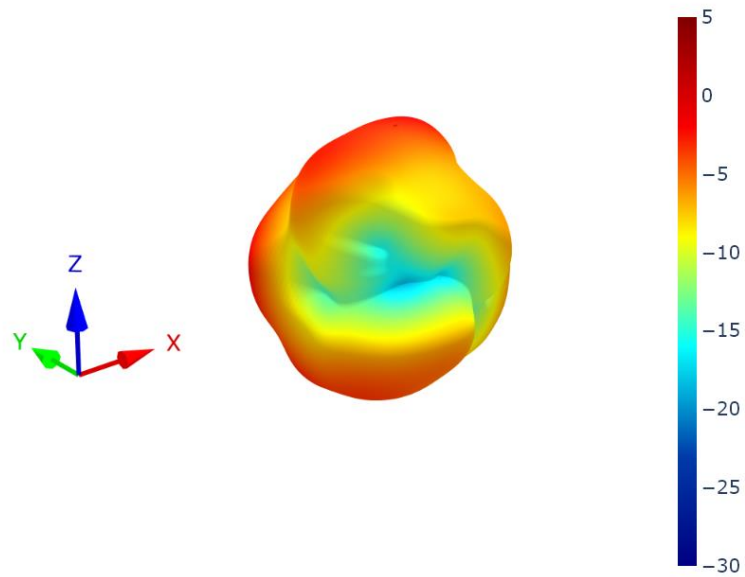

6.22 4G-5G 1 - Metal Box Patterns at 1470 MHz

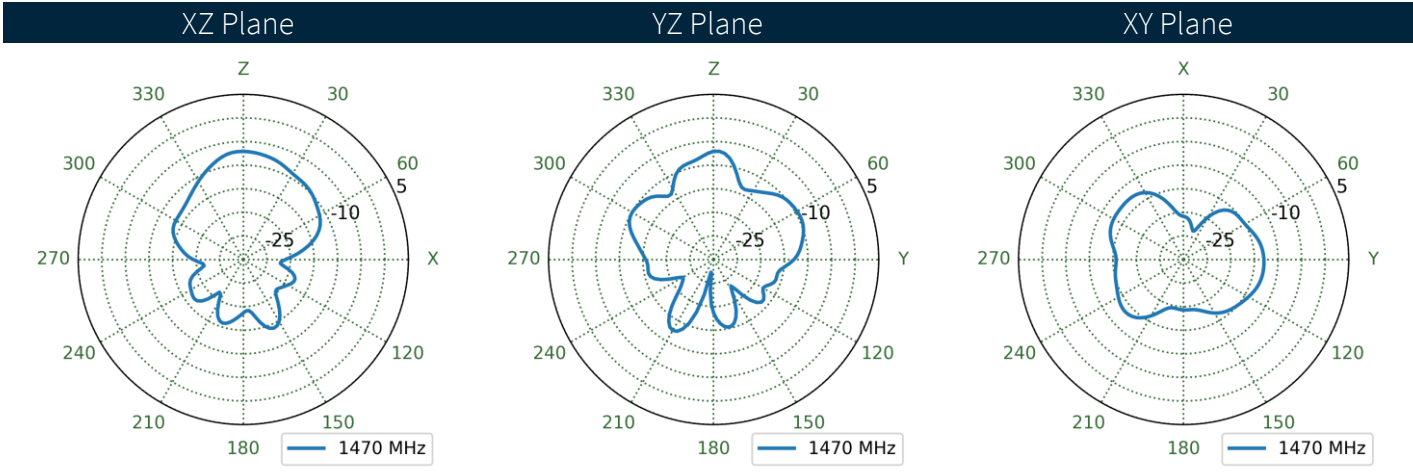
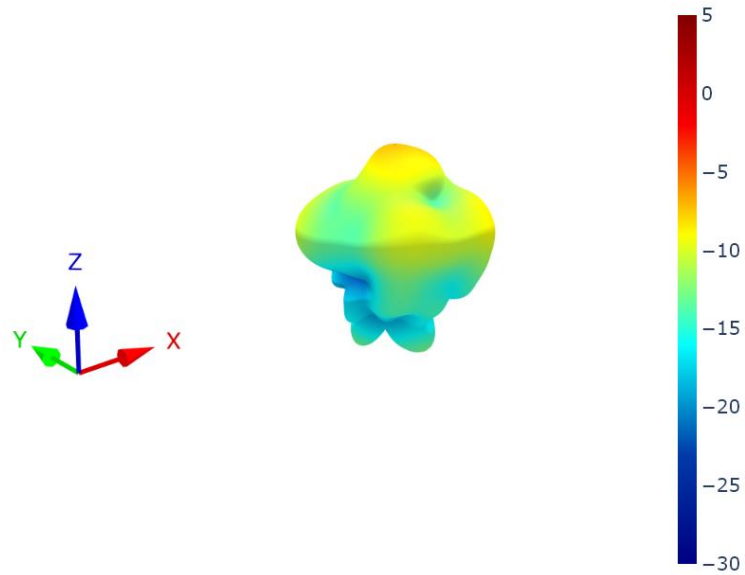

6.23 4G-5G 2 - 30x30cm Ground Plane Patterns at 1470 MHz

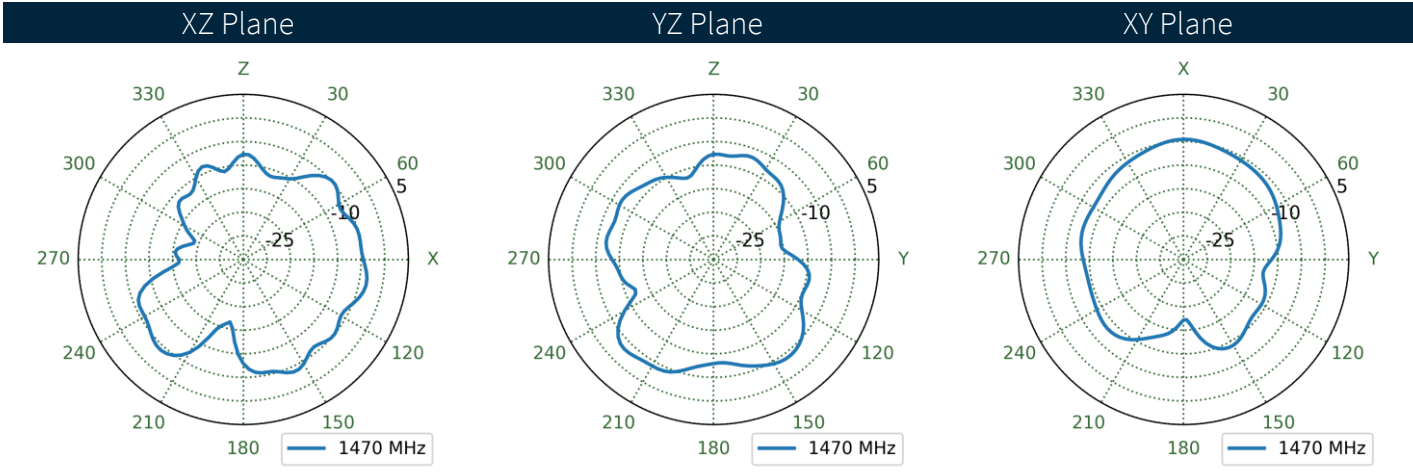
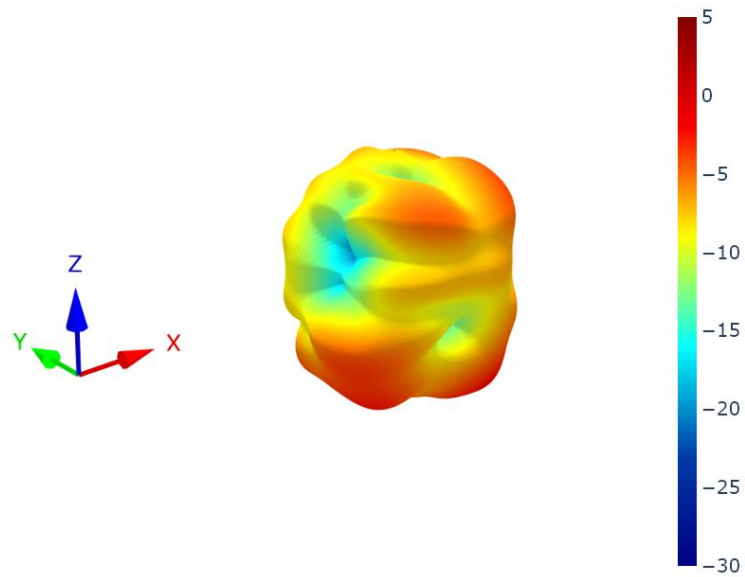

6.24 4G-5G 2 - Free Space Patterns at 1470 MHz

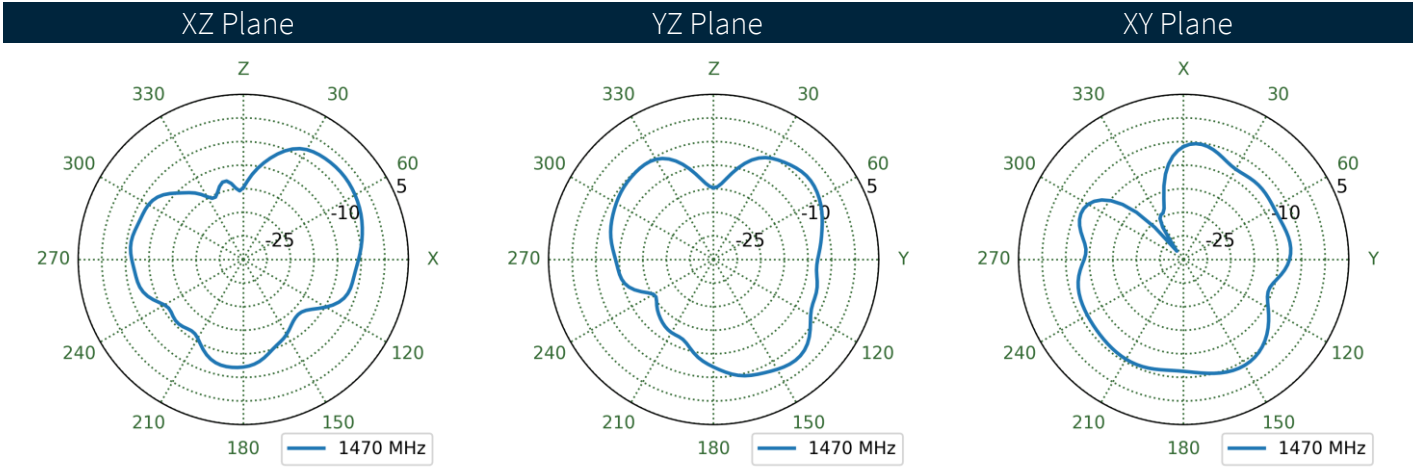
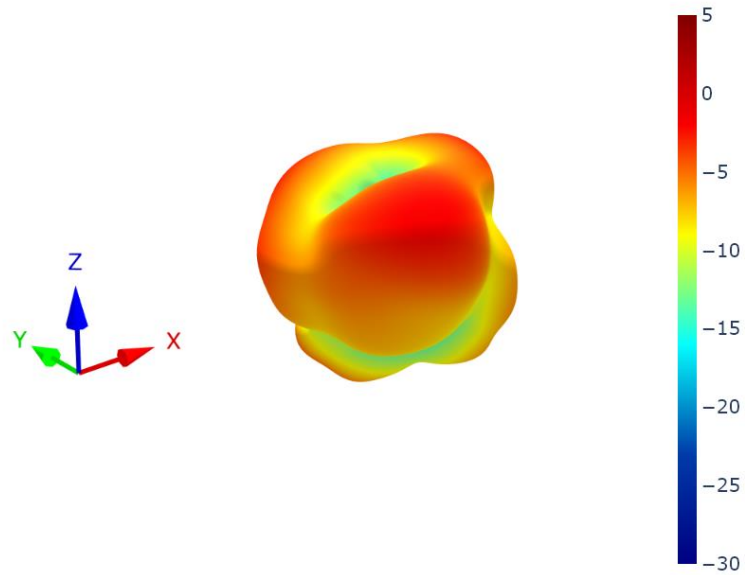

6.25 4G-5G 2 - Metal Box Patterns at 1470 MHz

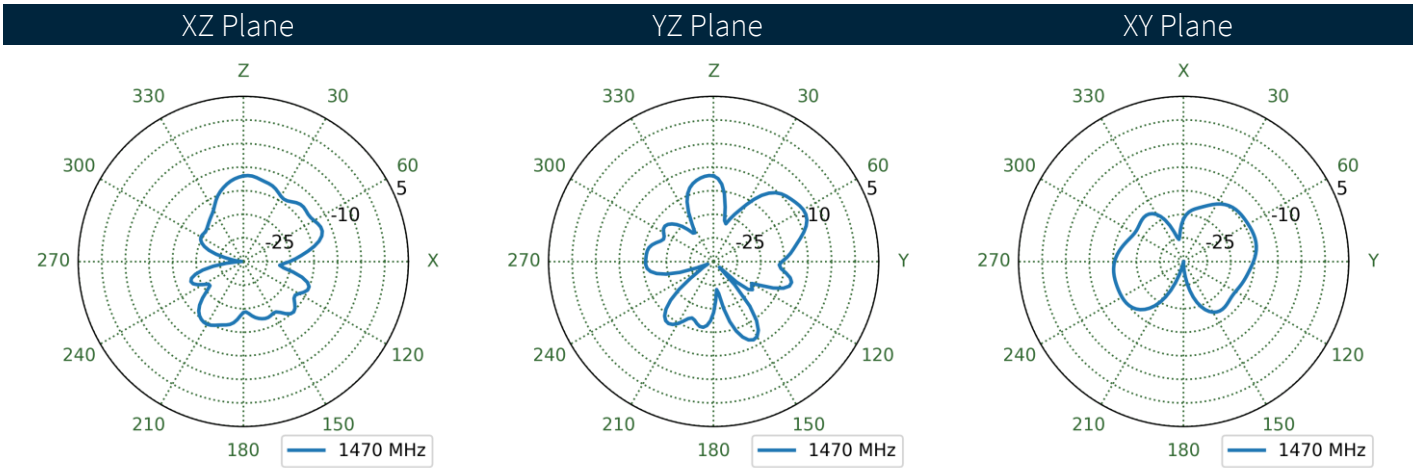
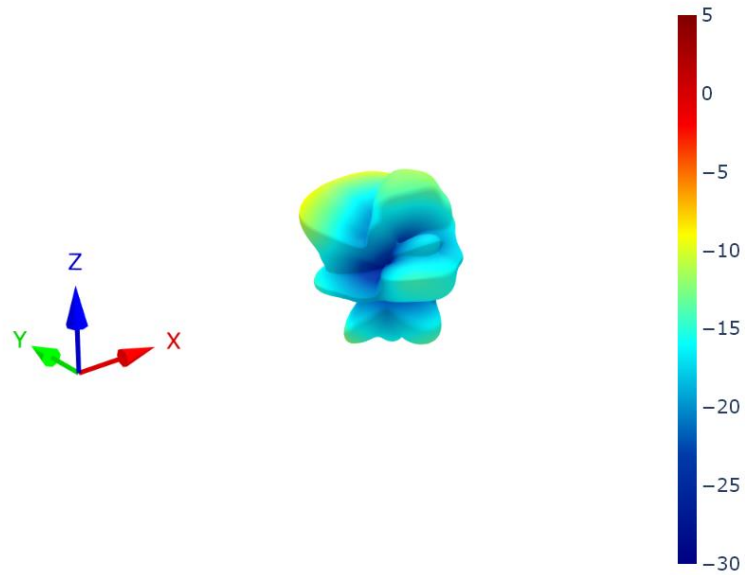

6.26 4G-5G 1 - 30x30cm Ground Plane Patterns at 1930 MHz

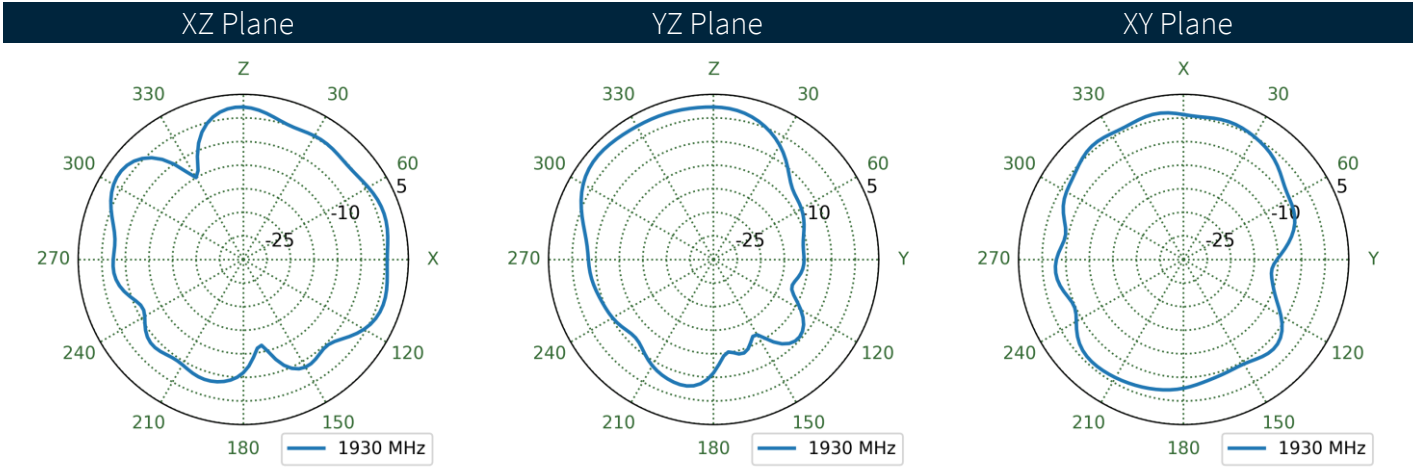
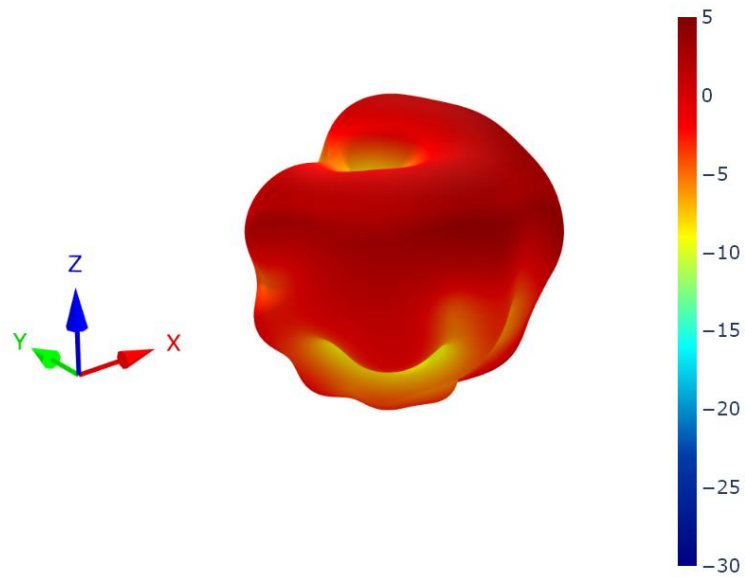

6.27 4G-5G 1 - Free Space Patterns at 1930 MHz

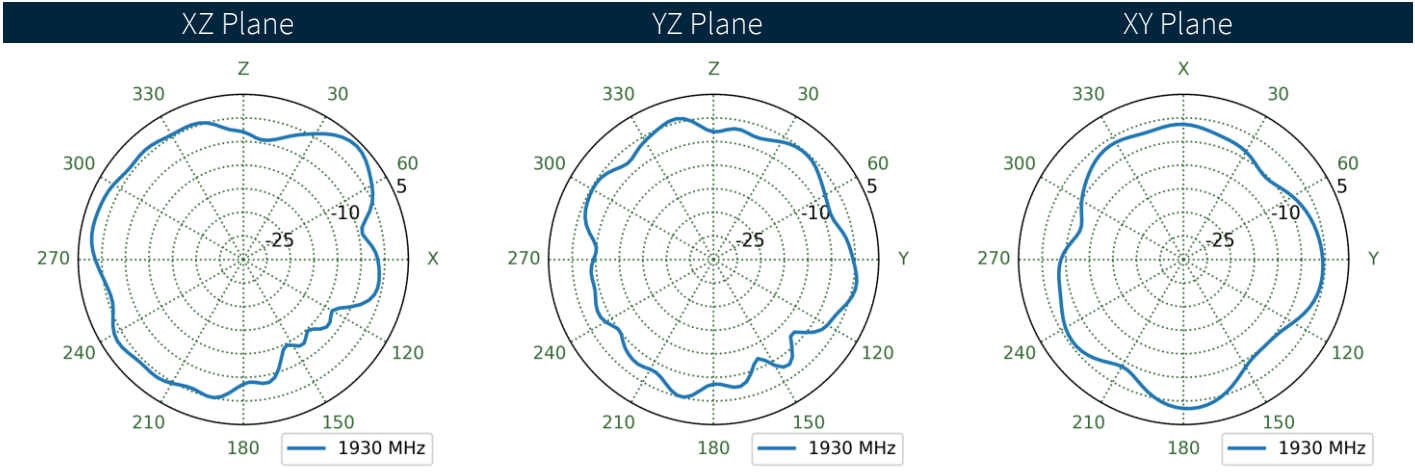
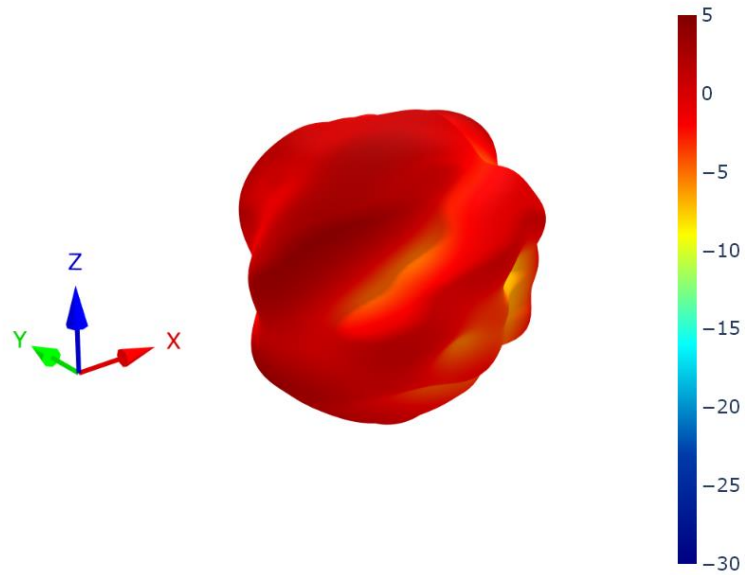

6.28 4G-5G 1 - Metal Box Patterns at 1930 MHz

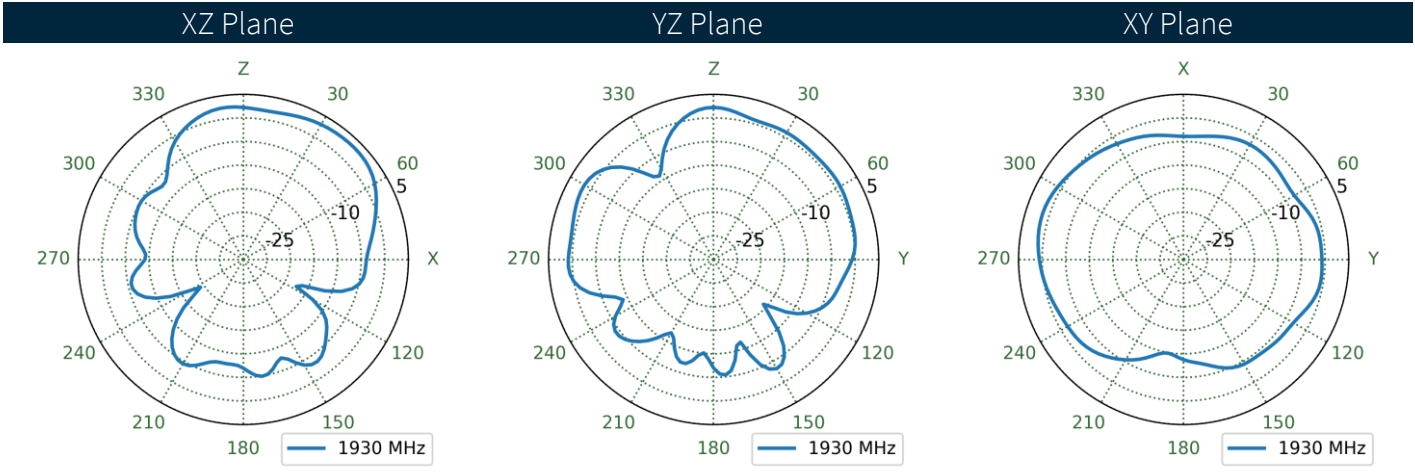
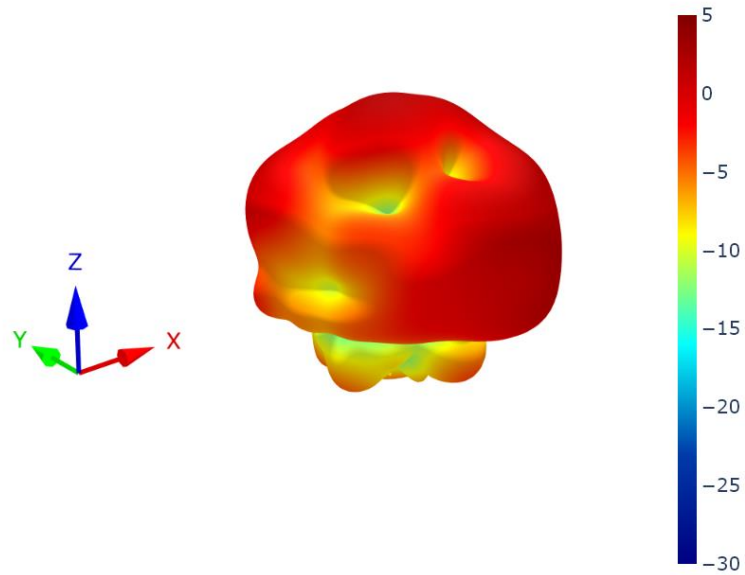

6.29 4G-5G 2 - 30x30cm Ground Plane Patterns at 1930 MHz

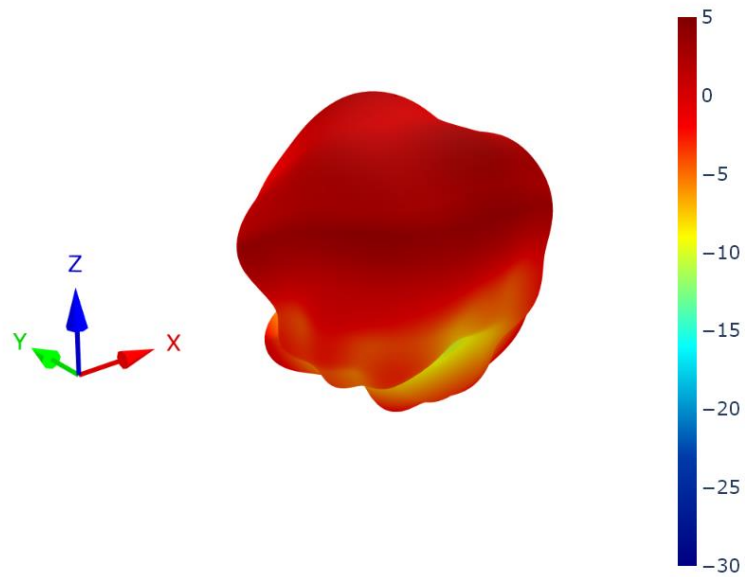

XZ Plane YZ Plane XY Plane

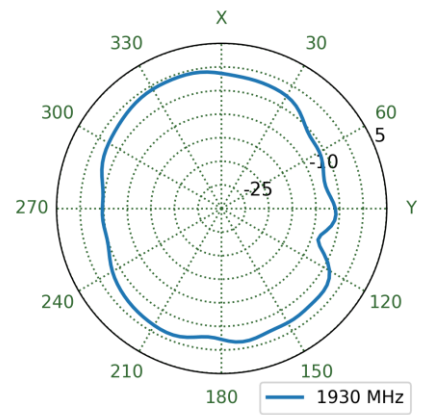
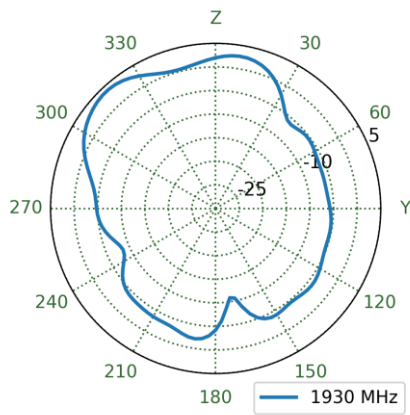
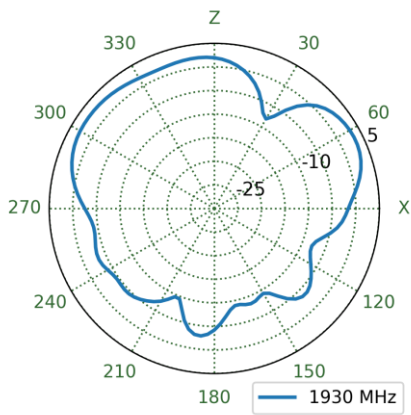

6.30 4G-5G 2 - Free Space Patterns at 1930 MHz

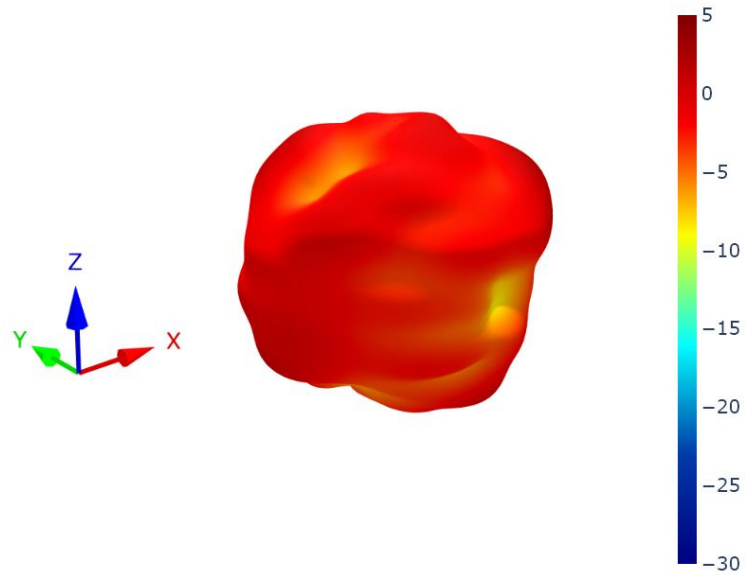

XZ Plane YZ Plane XY Plane

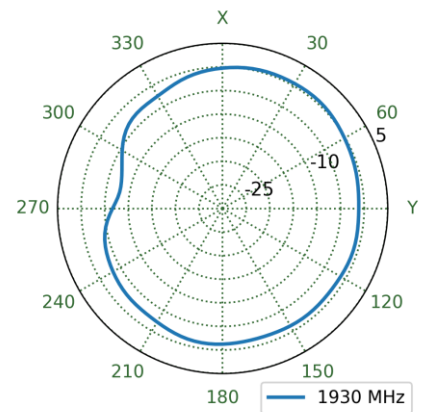
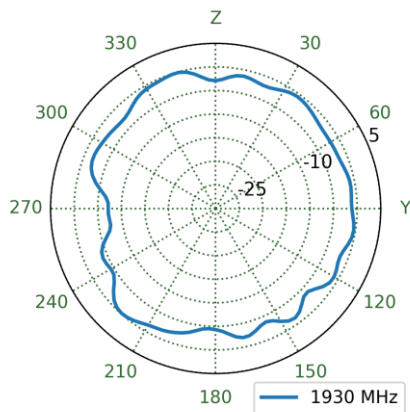
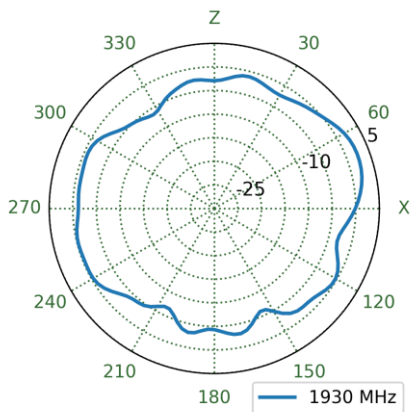

6.31 4G-5G 2 - Metal Box Patterns at 1930 MHz

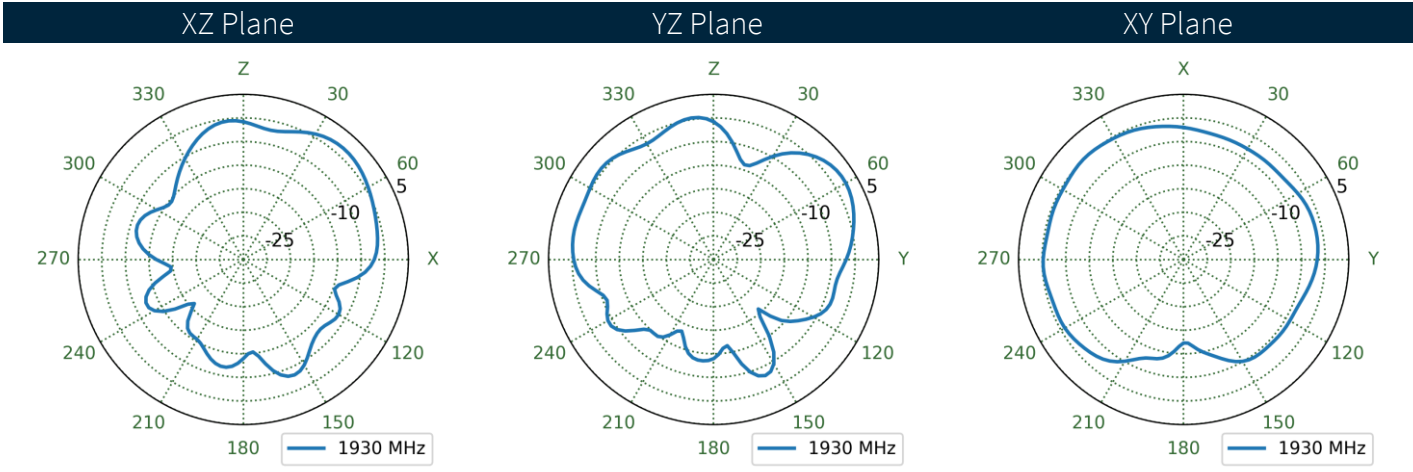
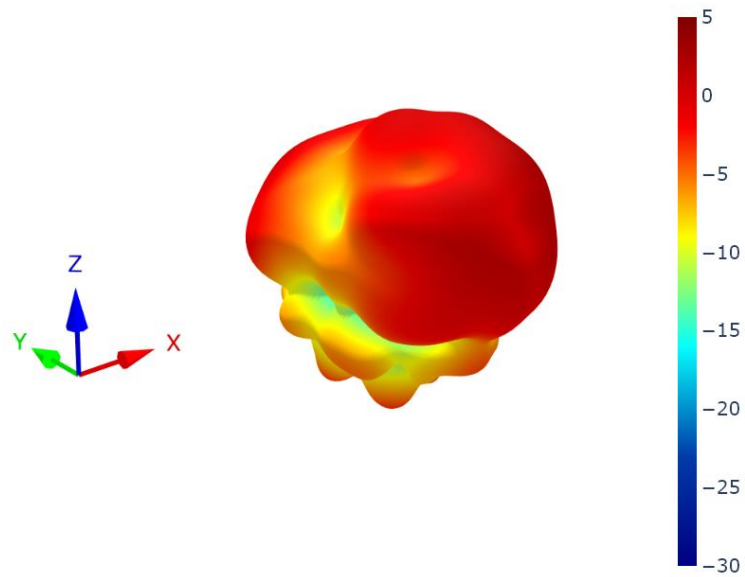

6.32 4G-5G 1 - 30x30cm Ground Plane Patterns at 2496 MHz

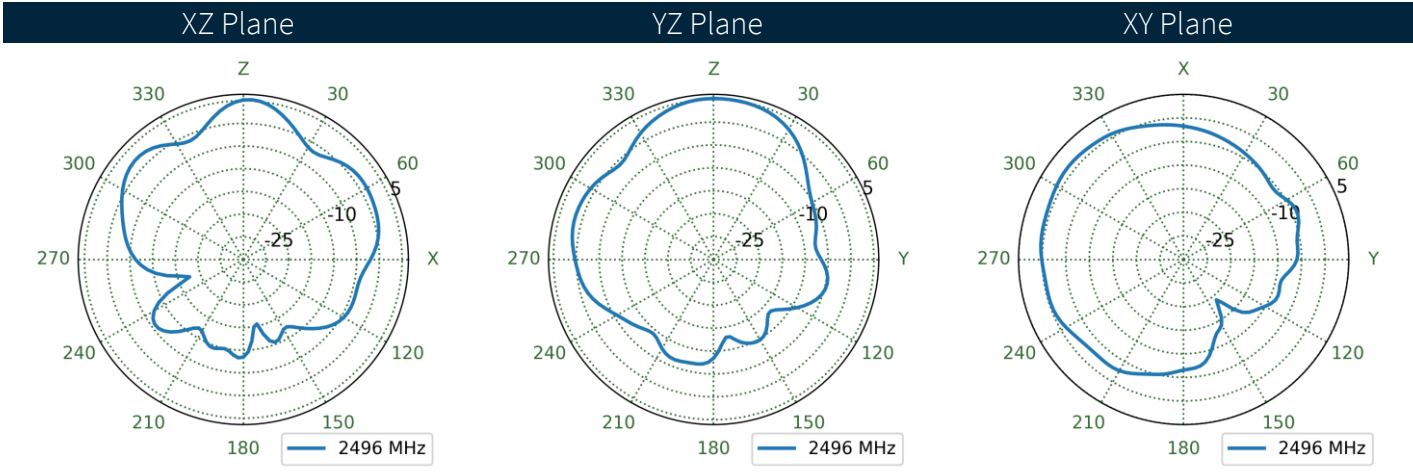
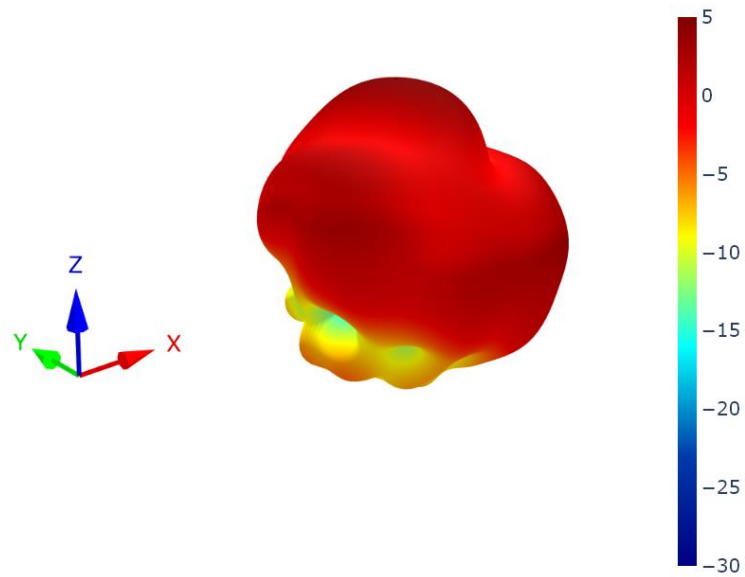

6.33 4G-5G 1 - Free Space Patterns at 2496 MHz

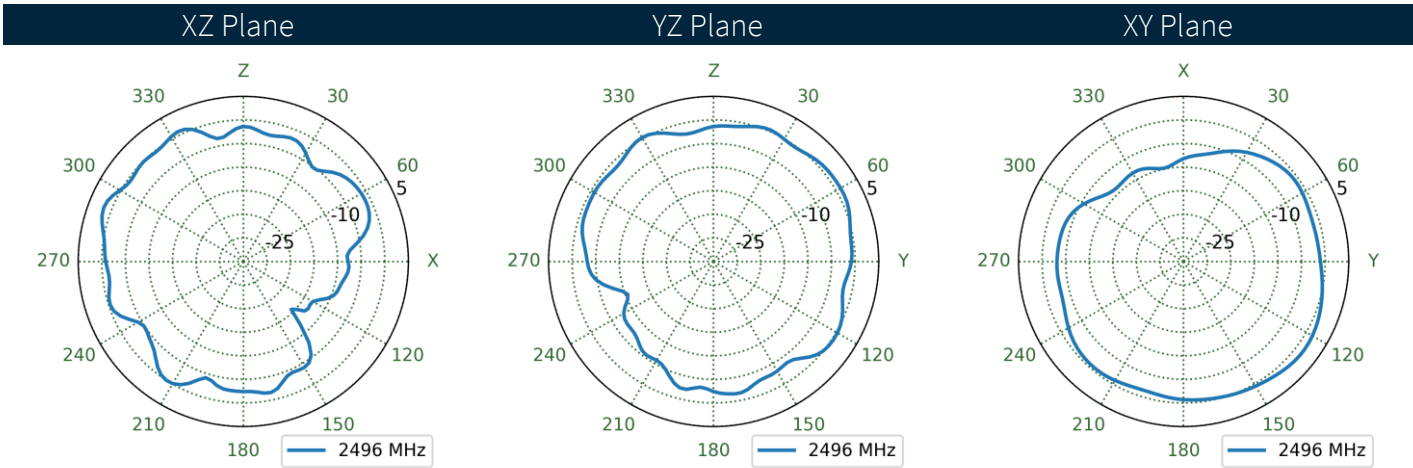
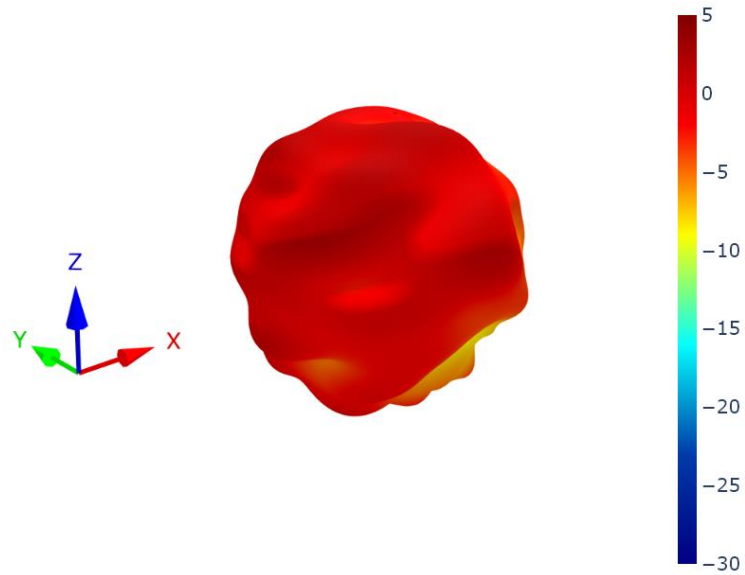

6.34 4G-5G 1 - Metal Box Patterns at 2496 MHz

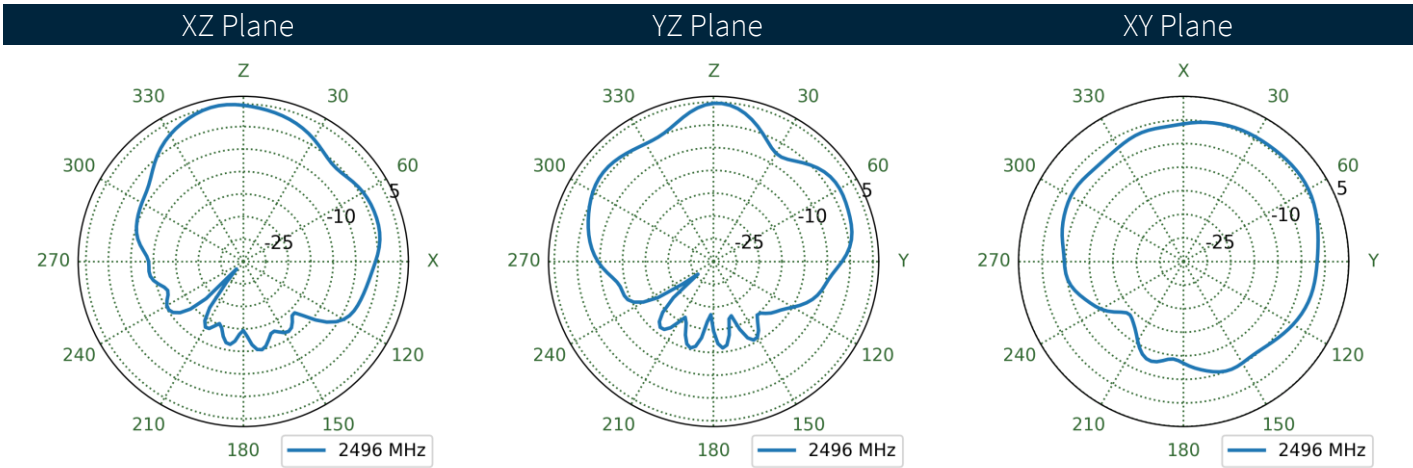
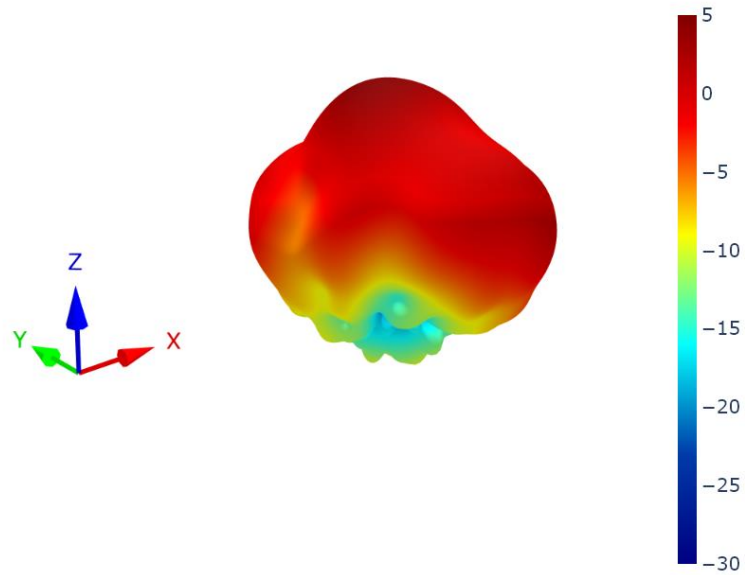

6.35 4G-5G 2 - 30x30cm Ground Plane Patterns at 2496 MHz

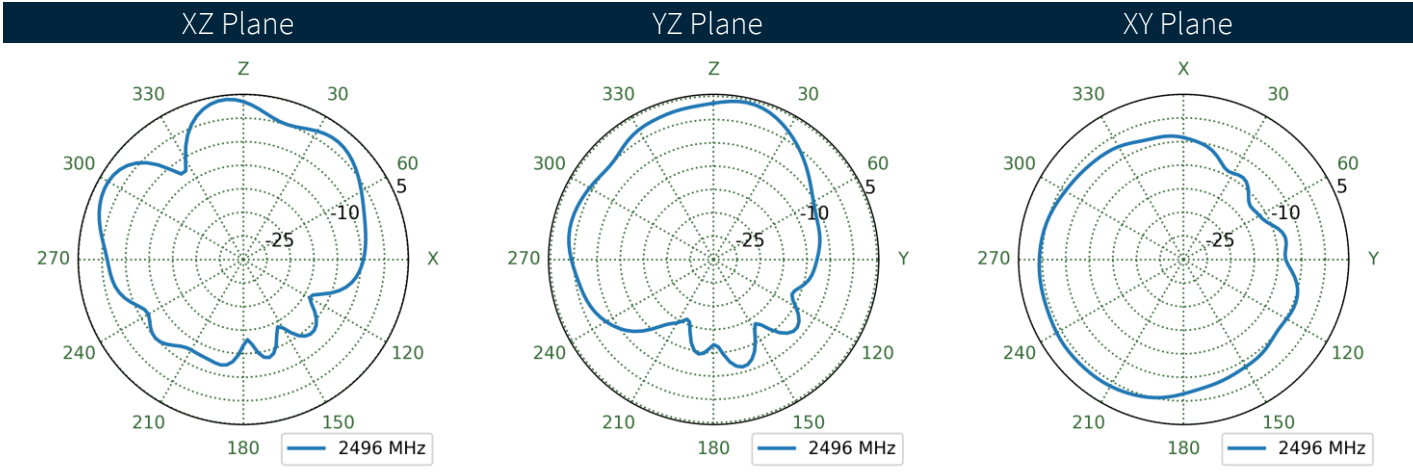
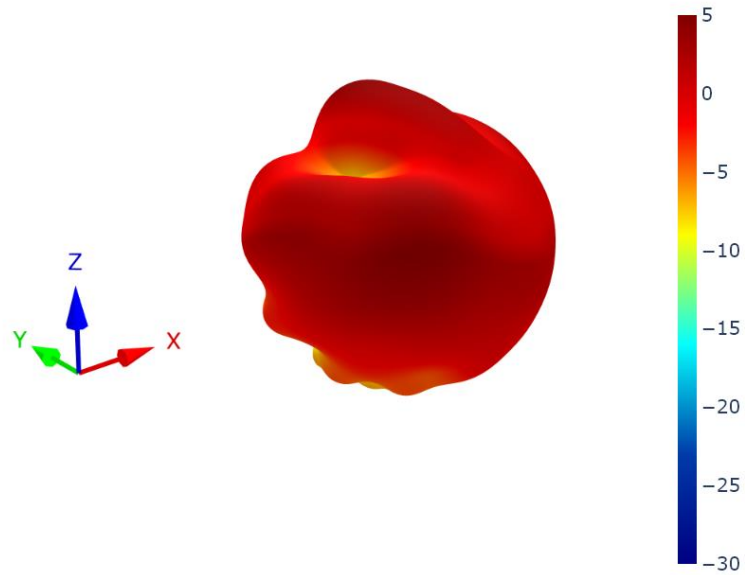

6.36 4G-5G 2 - Free Space Patterns at 2496 MHz

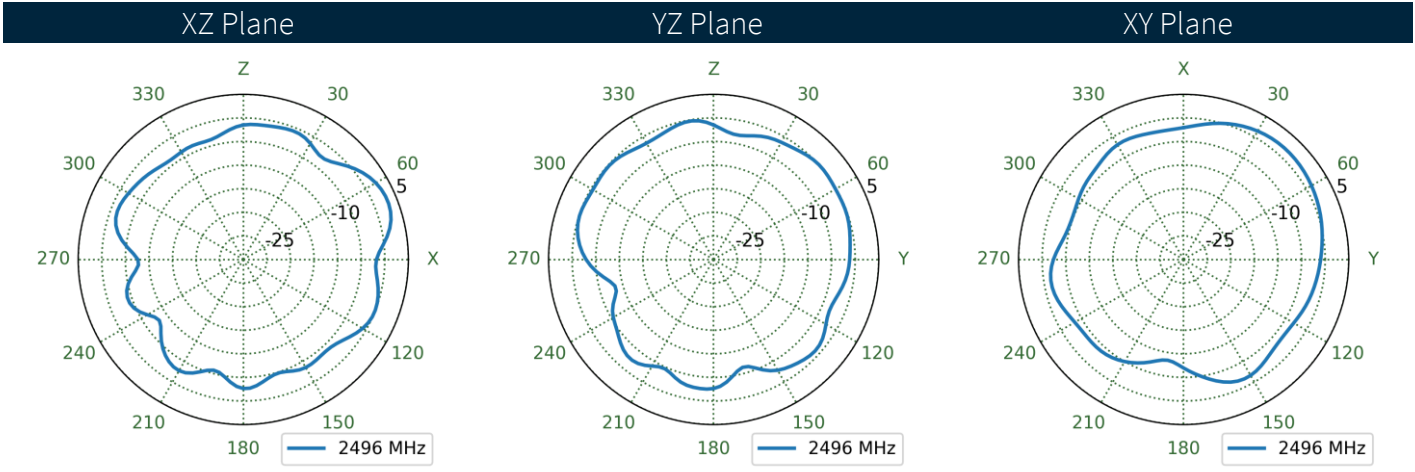
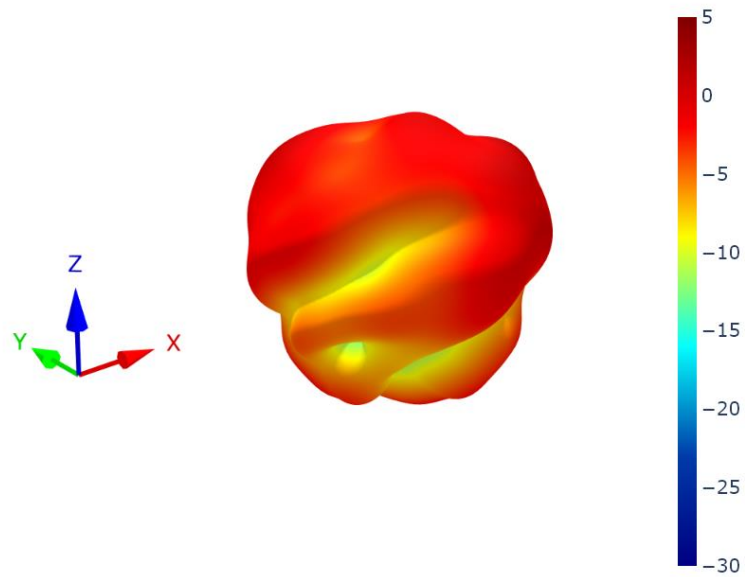

6.37 4G-5G 2 - Metal Box Patterns at 2496 MHz

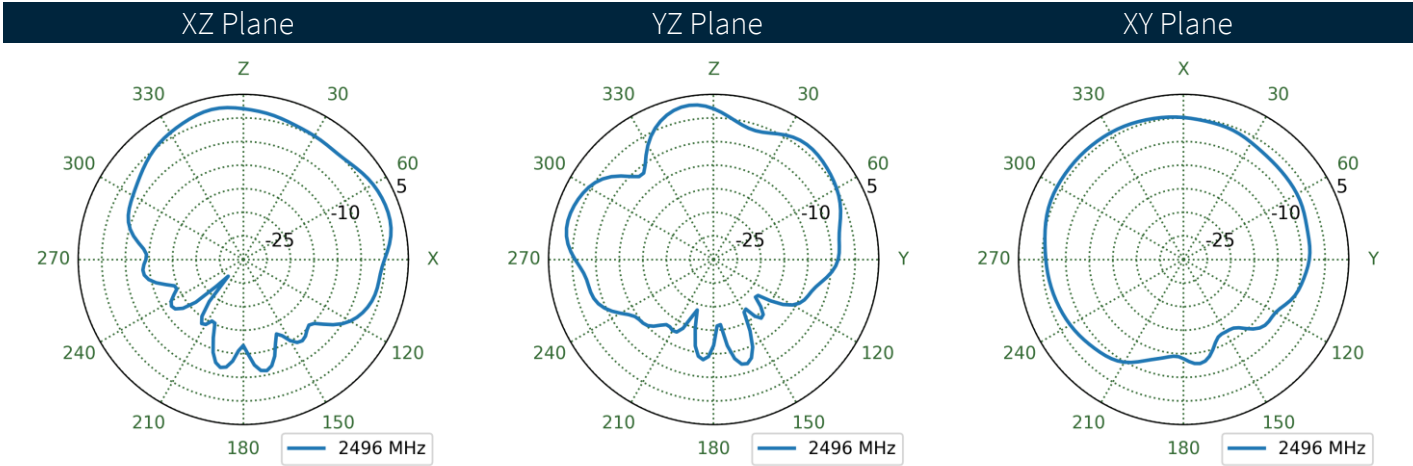
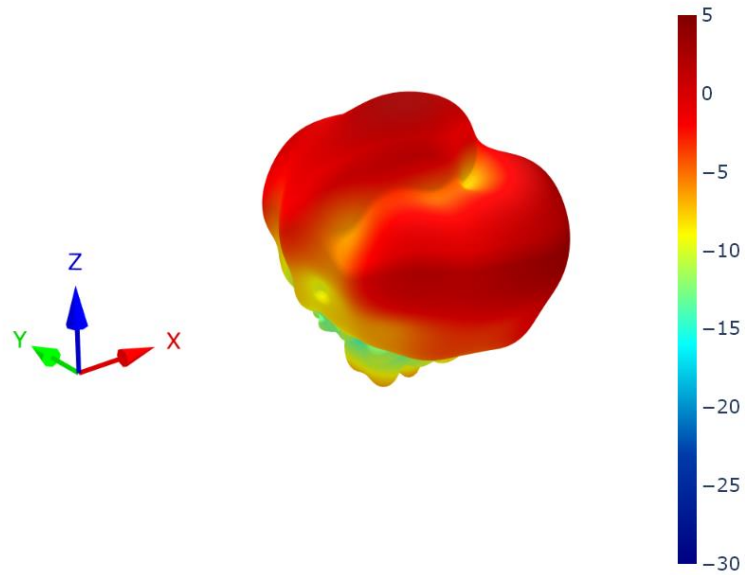

6.38 4G-5G 1 - 30x30cm Ground Plane Patterns at 4200 MHz

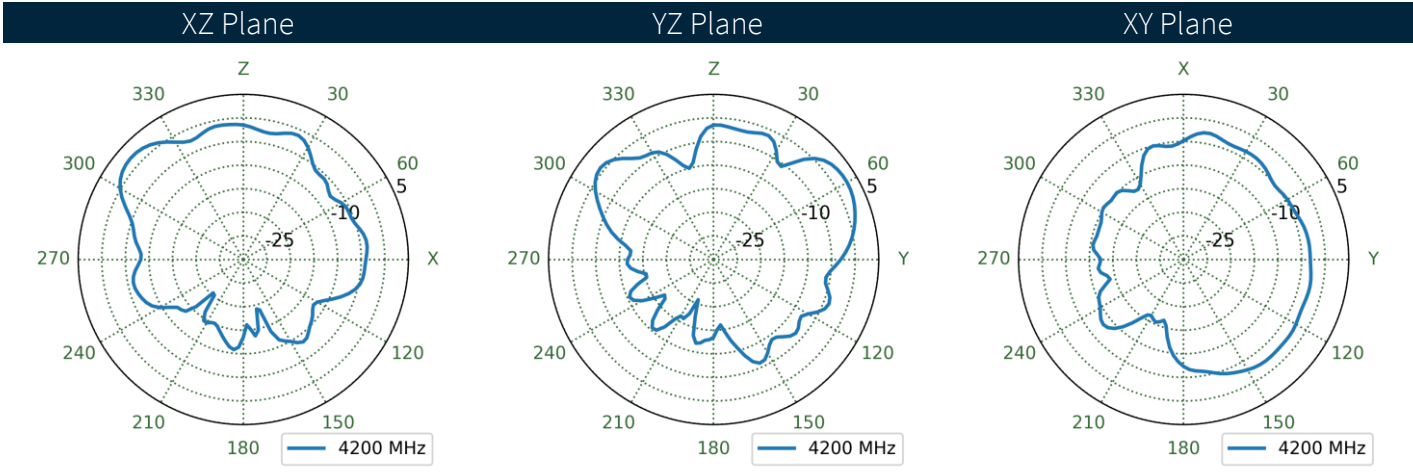
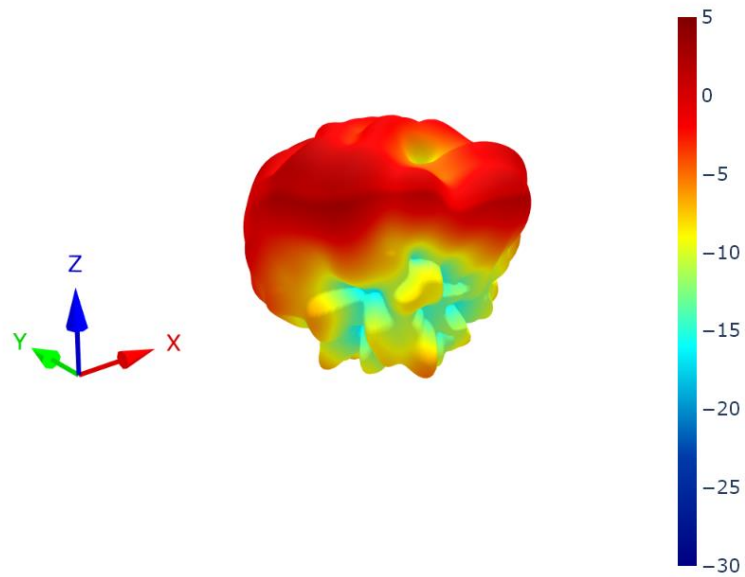

6.39 4G-5G 1 - Free Space Patterns at 4200 MHz

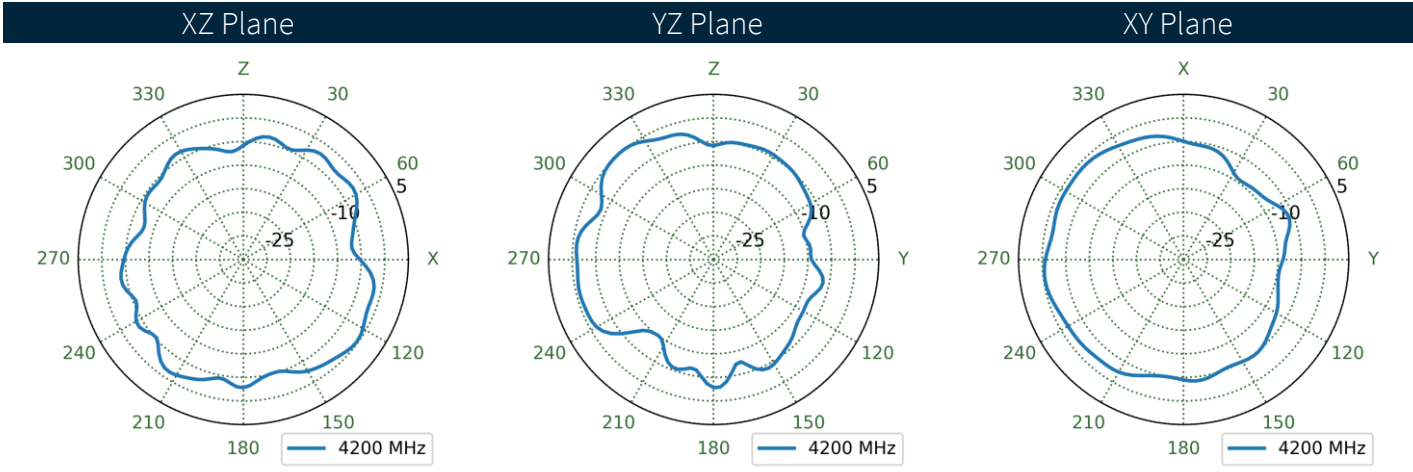
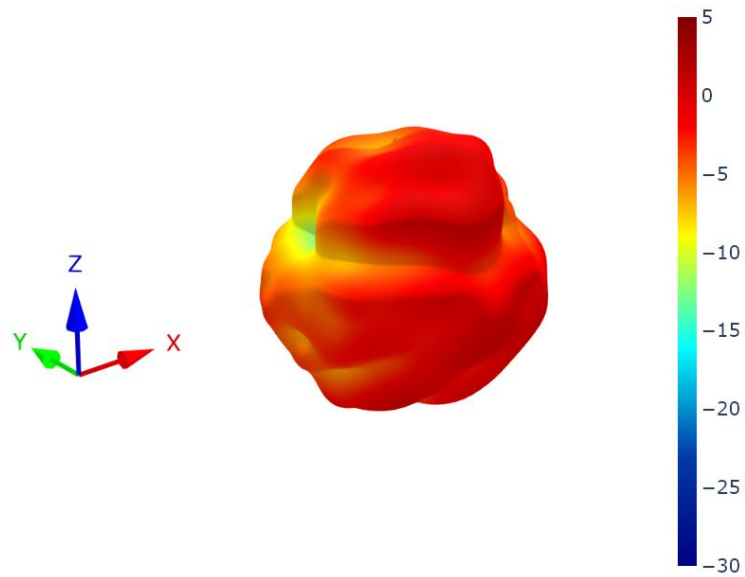

6.40 4G-5G 1 - Metal Box Patterns at 4200 MHz

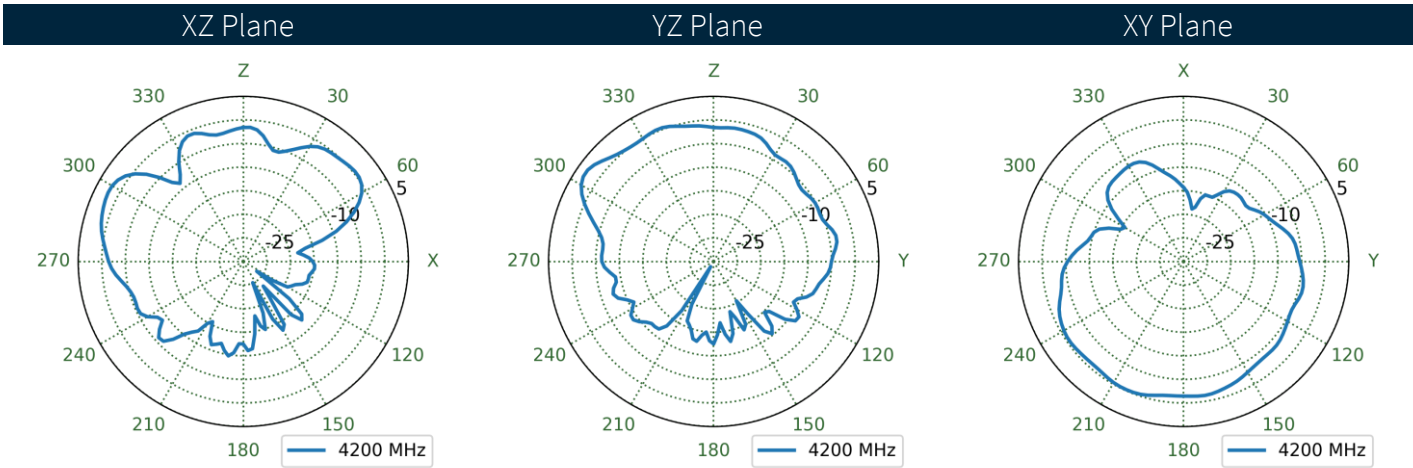
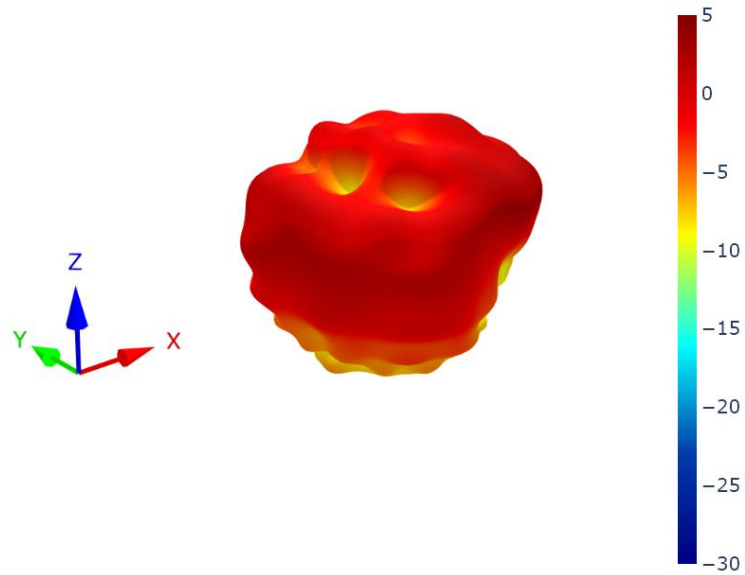

6.41 4G-5G 2 - 30x30cm Ground Plane Patterns at 4200 MHz

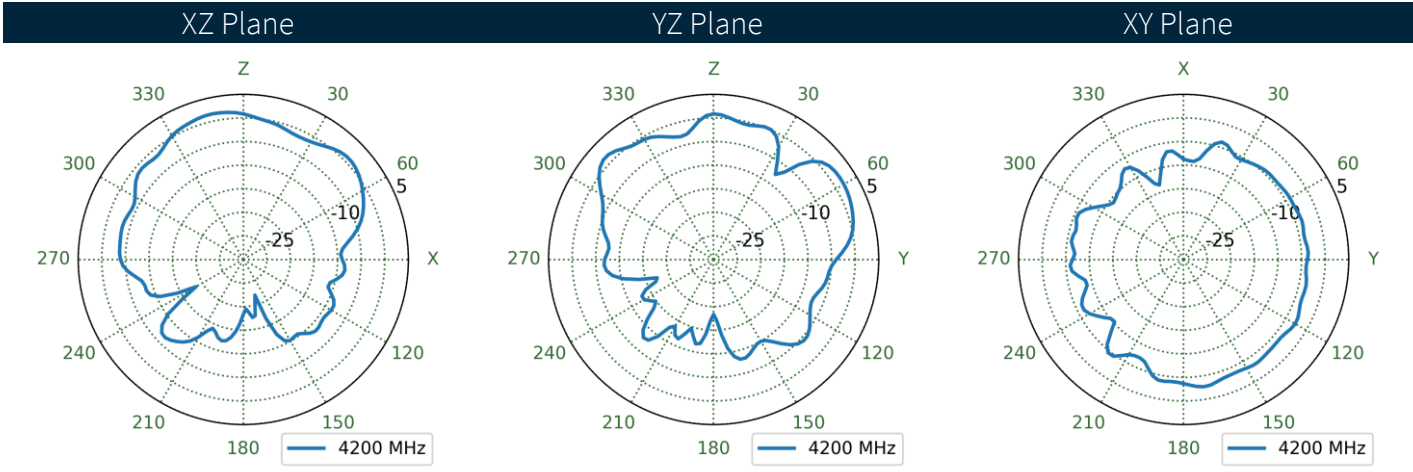
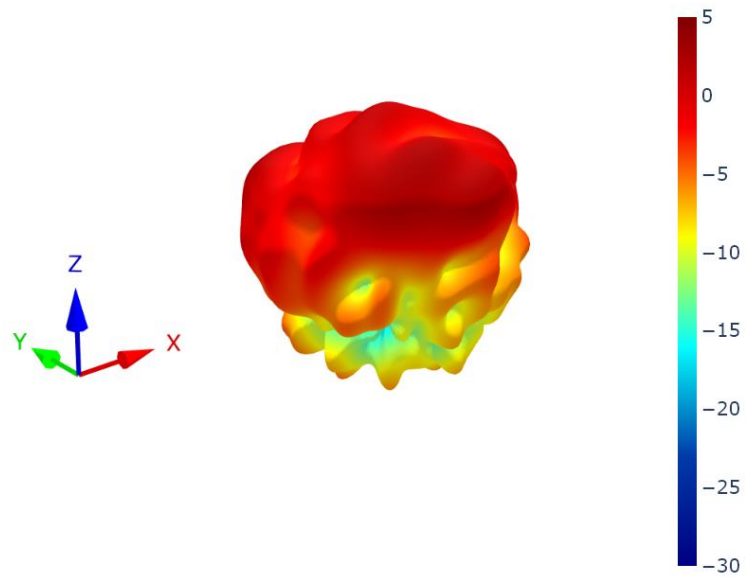

6.42 4G-5G 2 - Free Space Patterns at 4200 MHz

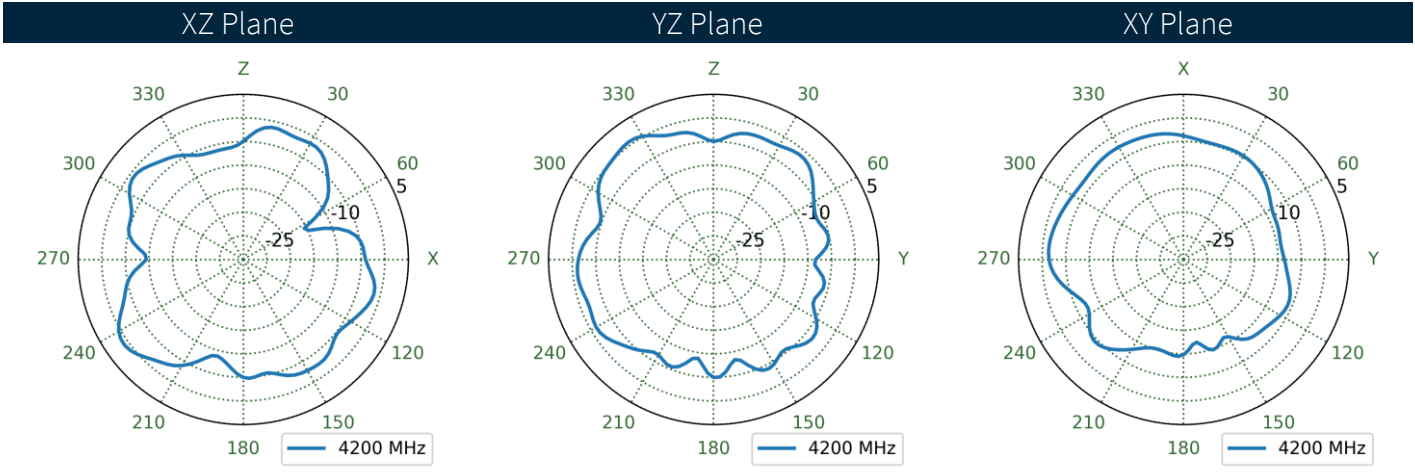
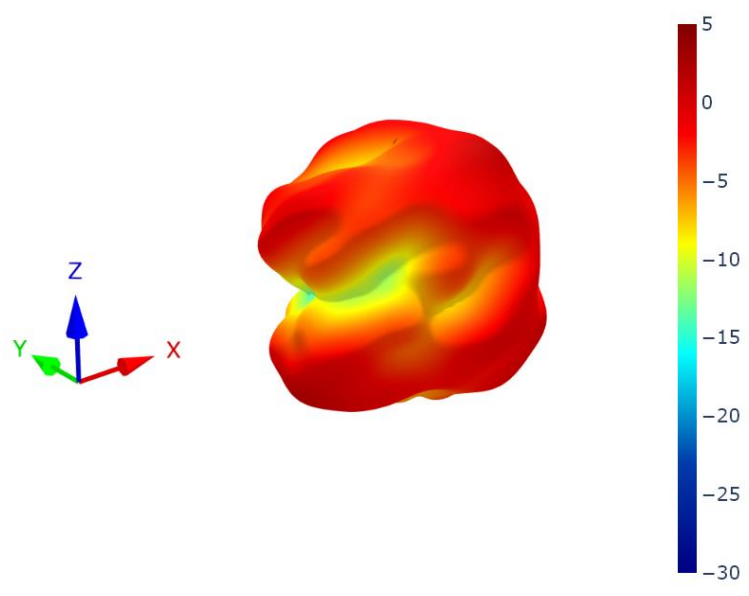

6.43 4G-5G 2 - Metal Box Patterns at 4200 MHz

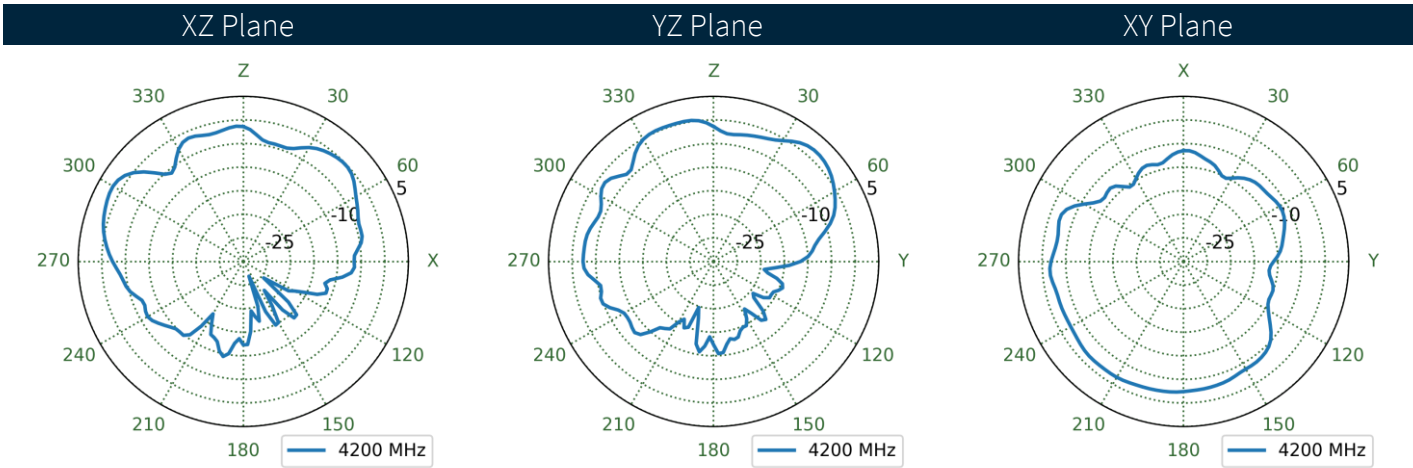
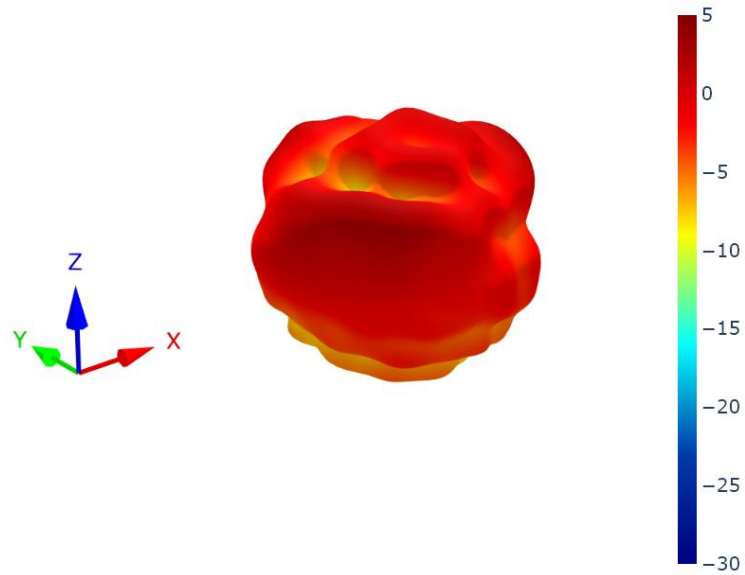

6.44 4G-5G 1 - 30x30cm Ground Plane Patterns at 5530 MHz

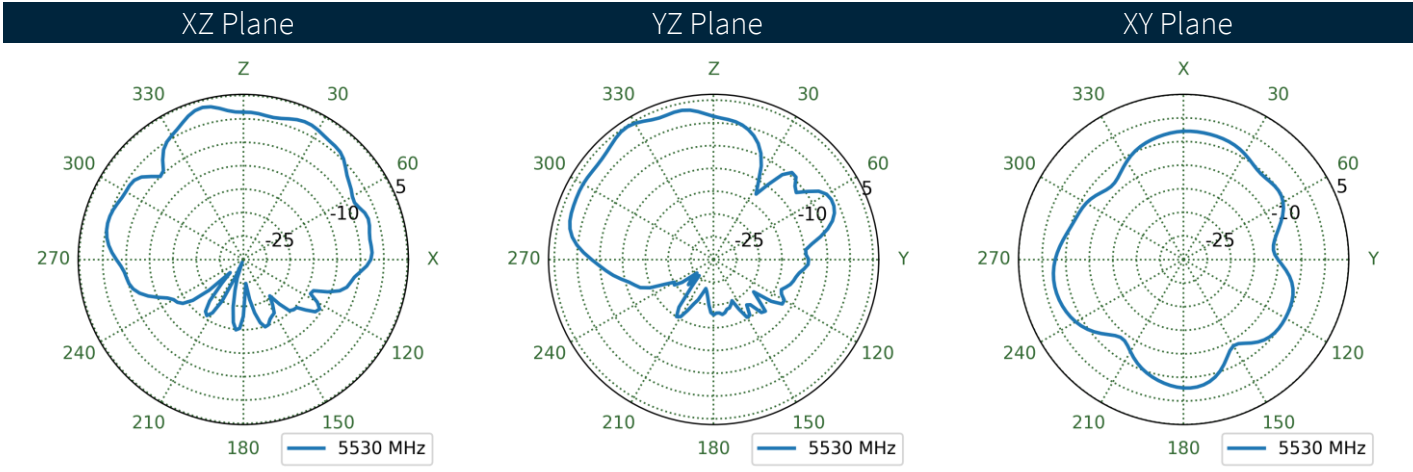
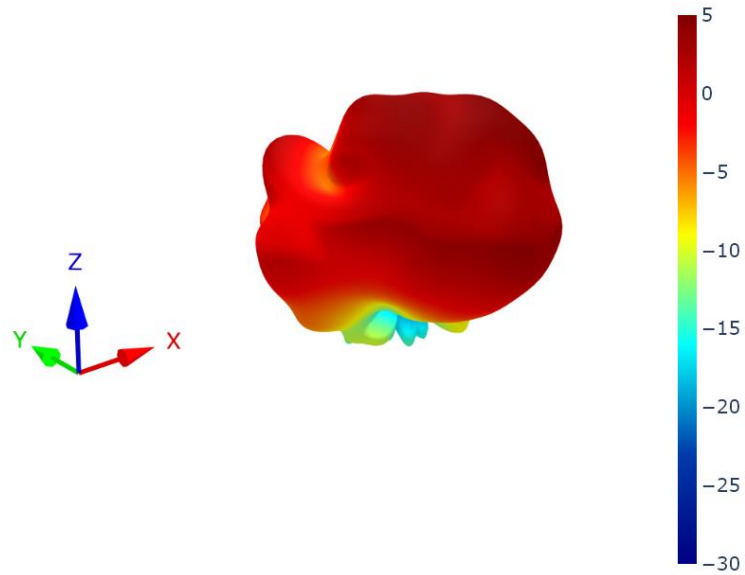

6.45 4G-5G 1 - Free Space Patterns at 5530 MHz

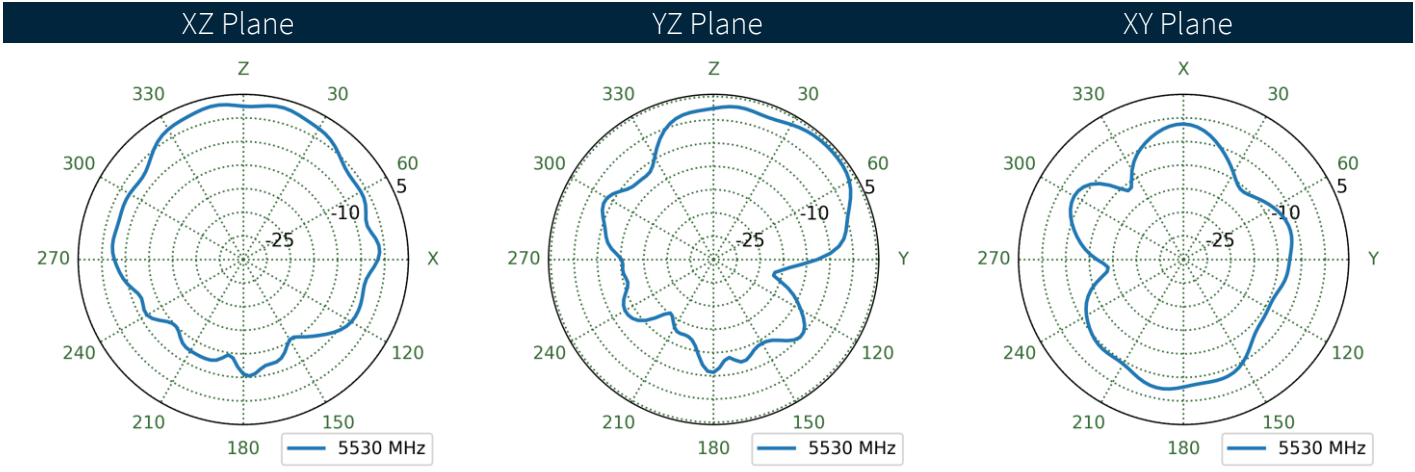
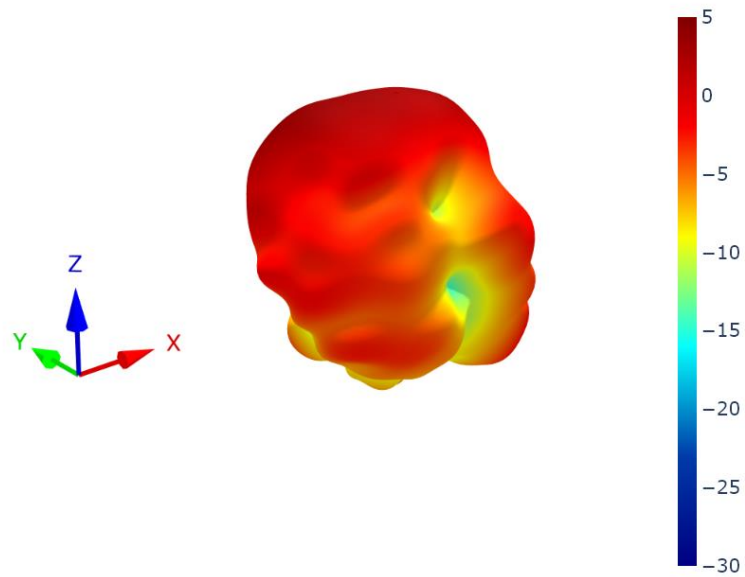

6.46 4G-5G 1 - Metal Box Patterns at 5530 MHz

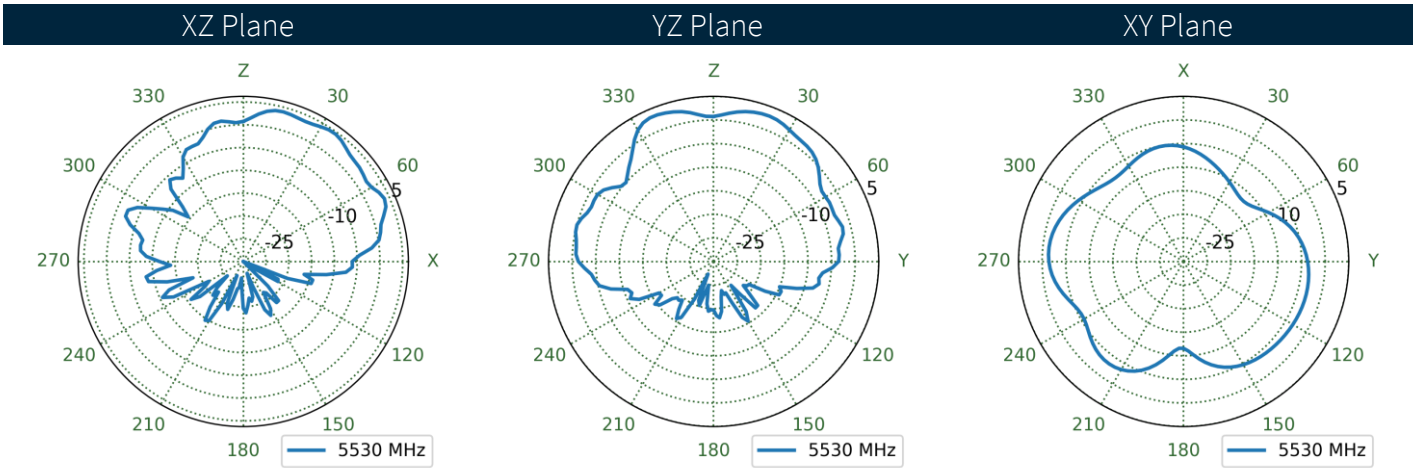
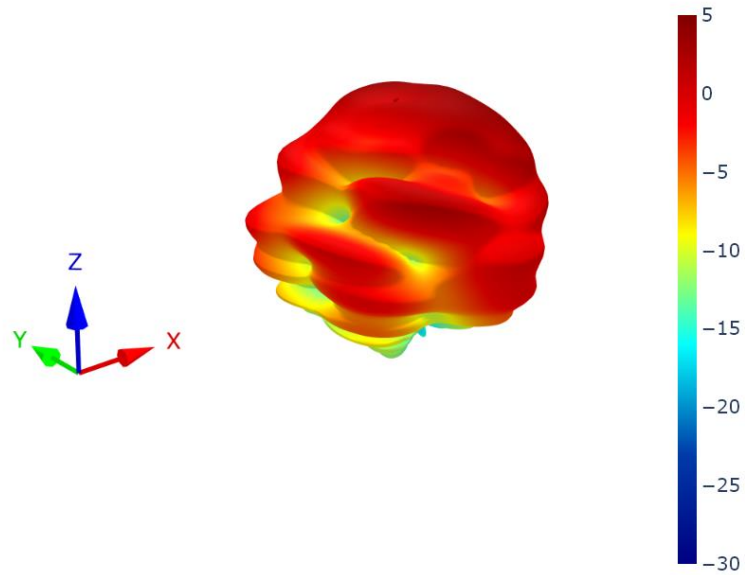

6.47 4G-5G 2 - 30x30cm Ground Plane Patterns at 5530 MHz

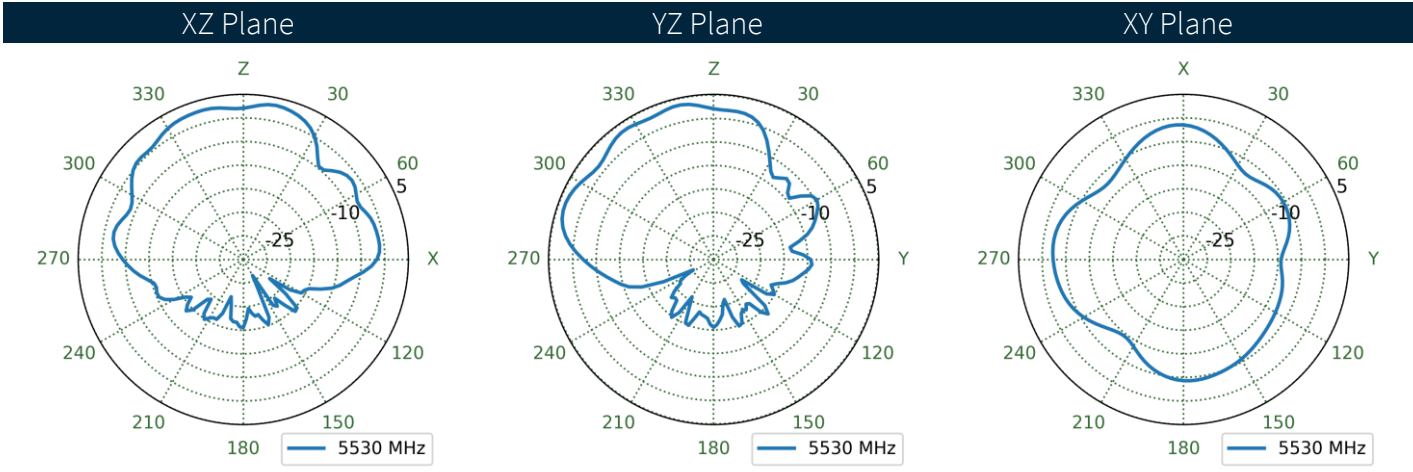
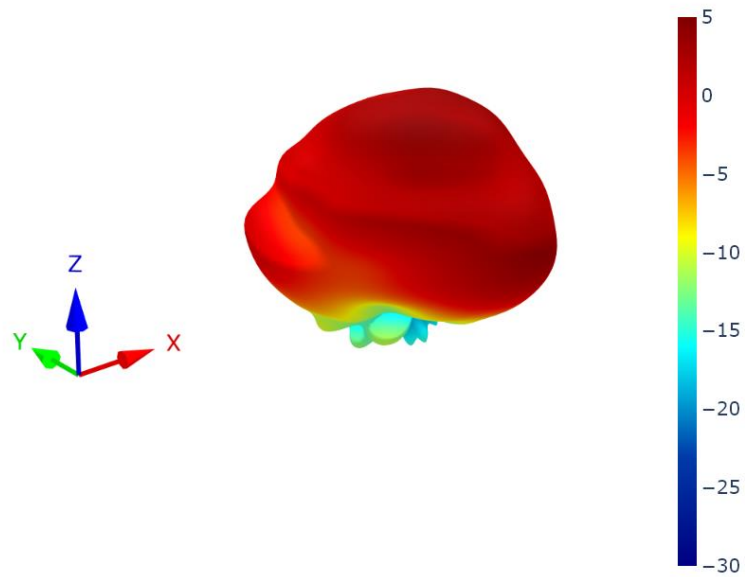

6.48 4G-5G 2 - Free Space Patterns at 5530 MHz

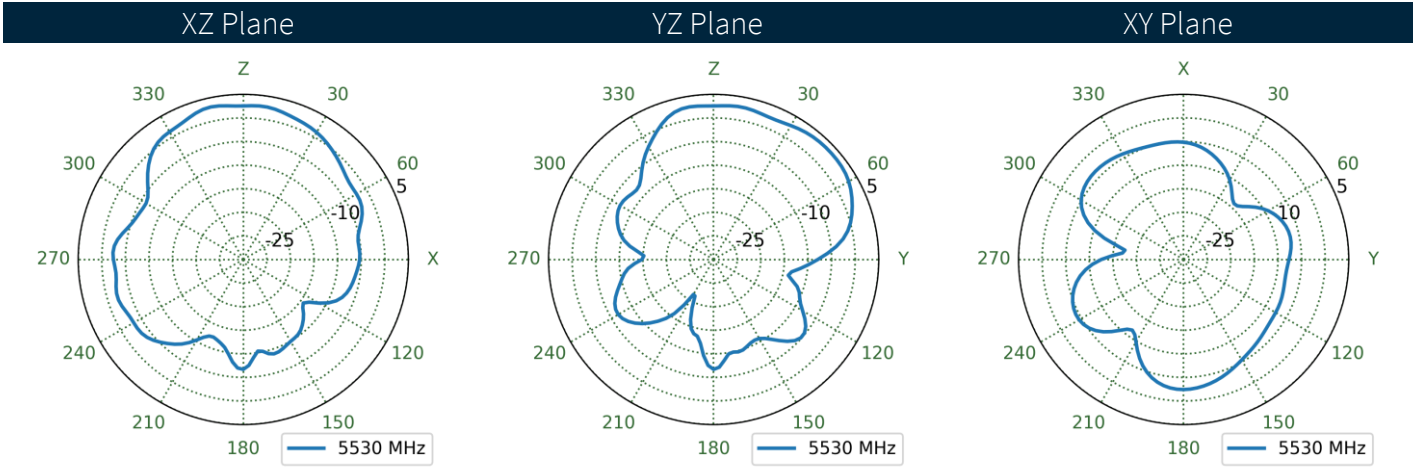
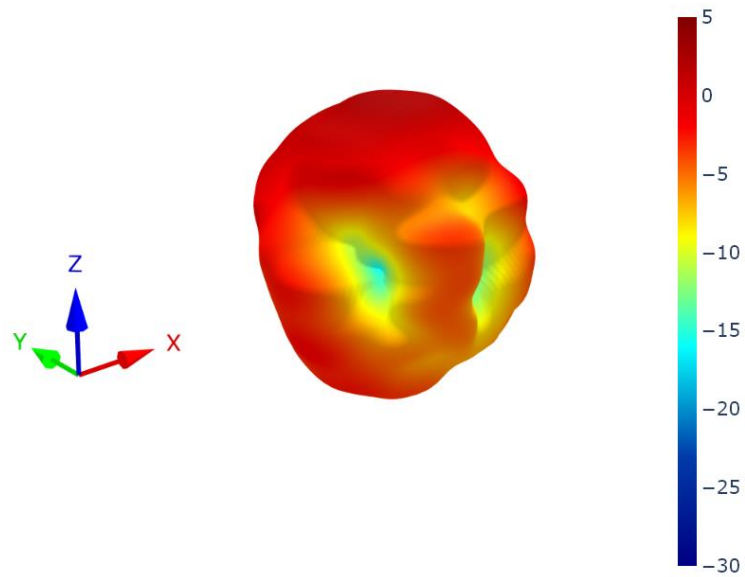

6.49 4G-5G 2 - Metal Box Patterns at 5530 MHz

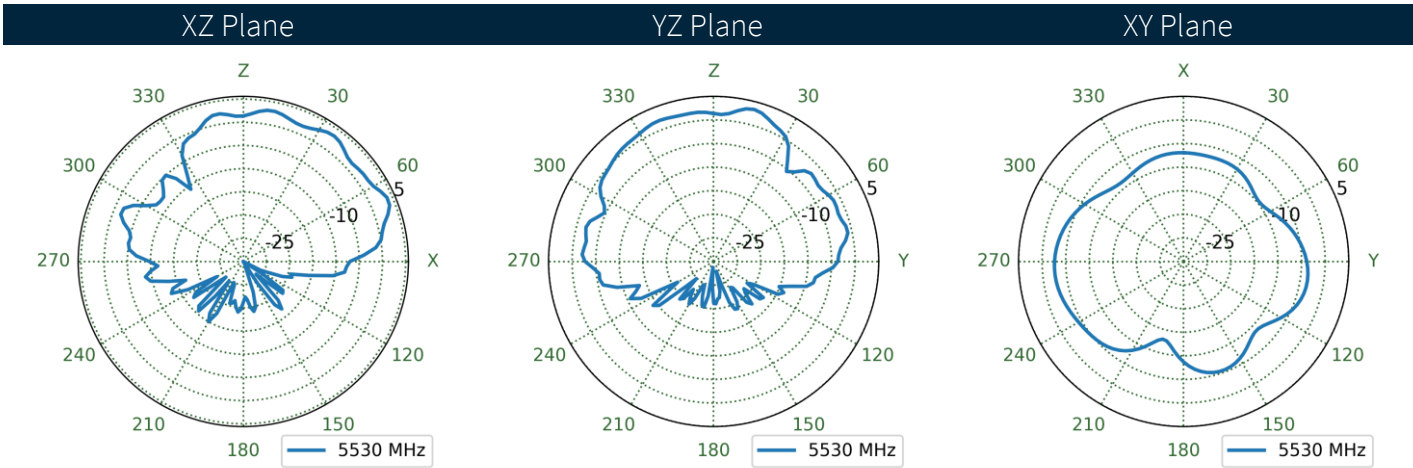
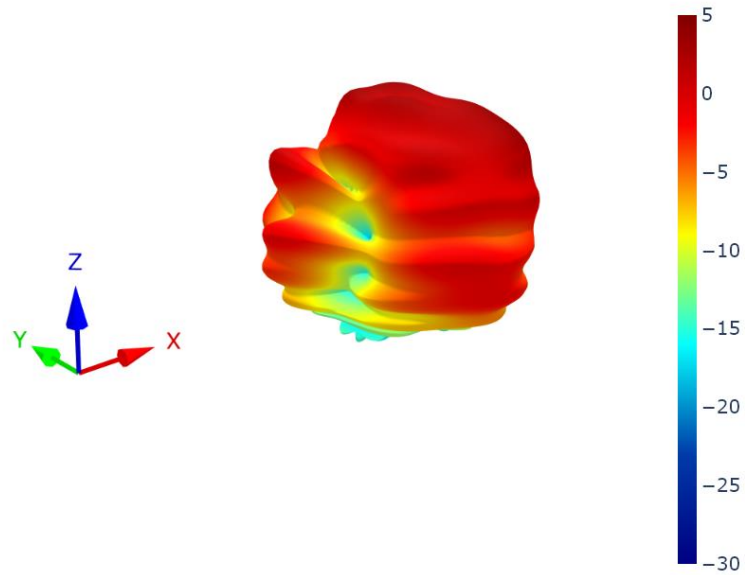

Changelog for the datasheet

SPE-24-8-305 – MA182.W.001

Revision: A (Original First Release)

Date: 2024-12-09

Notes: Initial Release

Author: Cesar Sousa

Previous Revisions



www.taoglas.com

