



TAOGLAS®



Datasheet

Part No:
MA342.W.BI.001

Description

2-in-1 White Magnetic Mount 4G/LTE MIMO
With 2m of RG-174 and SMA(M) Connectors

Features:

Compact, Magnetic Mount Antenna
2x LTE MIMO
Covers All Global Cellular Bands from 600-6000MHz
Dims: 58mm * 58mm * 65mm
Cable: 2m of RG174
Connector: SMA(M)
RoHS & Reach Compliant

1.	Introduction	3
2.	Specification	4
3.	Mechanical Drawing	5
4.	Antenna Characteristics	6
5.	Radiation Patterns	11
<hr/>		
	Changelog	37

Taoglas makes no warranties based on the accuracy or completeness of the contents of this document and reserves the right to make changes to specifications and product descriptions at any time without notice. Taoglas reserves all rights to this document and the information contained herein. Reproduction, use or disclosure to third parties without express permission is strictly prohibited.

Ireland & USA
ISO 9001:2015
Certified



Taiwan
ISO 9001:2015
Certified



1. Introduction



The Taoglas MA342 magnetic mount antenna has been designed for high performance 2-in-1 combination antenna with 2x 5G/4G MIMO. The robust, compact housing is just at only 65mm tall and 58mm in diameter, it is an ideal for external antenna for assets requiring Cellular and Wi-Fi connectivity.

The 5G/4G antenna, covers all worldwide LTE bands, includes many sub 6GHz, 5G FR1 bands and includes fallback to 3G/2G bands where required.

The IP67 rated enclosure is made from a durable, UV resistant ASA material that makes it resistant to vandalism or impact. An integrated rubber O-ring under the enclosure prevents water ingress under the antenna. It is mounted from the inside of the user device enclosure and the small thread allows for installation in situations where space is minimal.

Typical applications include:

- Smart Metering and Remote Monitoring
- Digital Signage
- Transportation and Telematics

Cable type and length, and connectors are fully customizable, and the MA342 can also be customized for other configurations. It is also available in black (MA342.A.LBI.001). Contact your regional Taoglas customer support team for more information.

2. Specification

LTE Electrical									
Band	Frequency (MHz)	Measurement	Efficiency (%)	Average Gain (dB)	Peak Gain (dBi)	Impedance	Polarization	Radiation Pattern	Max. input power
5GNR/4G Band71	617-698	LTE1	28.1	-5.51	-0.78	50 Ω	Linear	Omni	2W
		LTE2	24.7	-6.07	-0.91				
4G/3G Band 12,13,14,17,28,29	698-824	LTE1	44.7	-3.50	0.99				
		LTE2	43.3	-3.63	1.12				
4G/3G/NB-IoT/Cat M Band 5,8,18,19,20,26,27	824-960	LTE1	46.7	-3.31	0.99				
		LTE2	57.4	-2.41	1.55				
5GNR/4G Band 21,32,74,75,76	1427-1518	LTE1	33.2	-4.79	2.87				
		LTE2	30.6	-5.15	2.68				
4G/3G Band 1,2,3,4,9,23,25,35,39, 66	1710-2200	LTE1	65.3	-1.85	5.93				
		LTE2	63.5	-1.97	5.34				
4G/3G Band 7,30,38,40,41	2300-2690	LTE1	69.0	-1.61	5.64				
		LTE2	70.9	-1.50	5.95				
5GNR/4G Band 22,42,48,77,78,79	3300-5000	LTE1	55.7	-2.54	6.84				
		LTE2	61.6	-2.10	6.70				
LTE5200/Wi-Fi5800	5150-5925	LTE1	57.3	-2.42	6.00				
		LTE2	56.4	-2.48	5.97				

Mechanical	
Dimensions	58 x 58 x 65mm
Material	ASA
Connector	SMA(M)
Cable	2m of RG174

Environmental	
Temperature Range	-40 - +85°C
RoHs & REACH Compliant	Yes

3. Mechanical Drawing

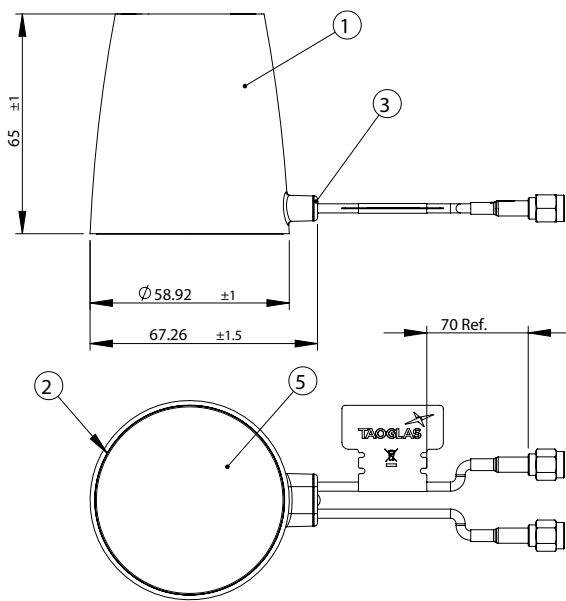
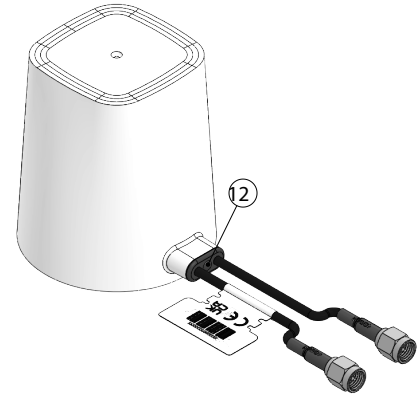
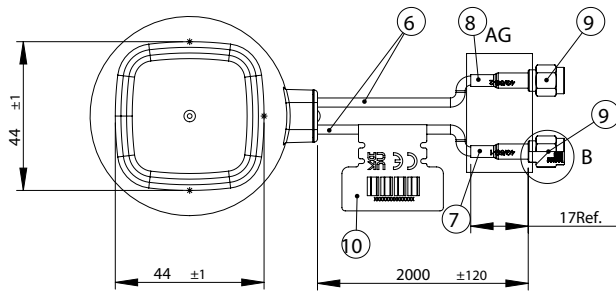

DETAIL AG
SCALE 1 : 1

	Name	Material	Finish	Qty
1	Top housing	ASA	White	1
2	Bottom housing	ASA	Black	1
3	Grommet	Silicone Rubber	Black	1
4	Magnet pack/N48	NdFeB	Ni Plated	1
5	Matte Silver Label	PET	Matte Silver	1
6	RG174 Coaxial Cable	PVC	Black	2
7	Heat Shrink Tube(4G/5G-1)	PE	Red Tube/White Text	1
8	Heat Shrink Tube(4G/5G-2)	PE	Red Tube/White Text	1
9	SMA(M)ST Plug_for RG-316/RG-174	Brass	Au Plated	2
10	CE,WEEE and UKCA mark logo Label	PEPA	White	1
11	Double Sided Adhesive	3M VHB 5952	Black foam/Red liner	1
12	Grommet plug_RG174	ASA	Black	1

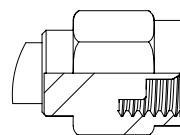

DETAIL B
SCALE 2 : 1

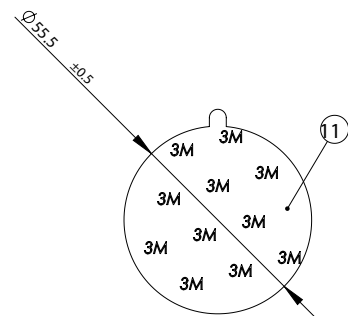

Accessory

4. Packaging

1 PCS /PE Bag
Weight: 161g

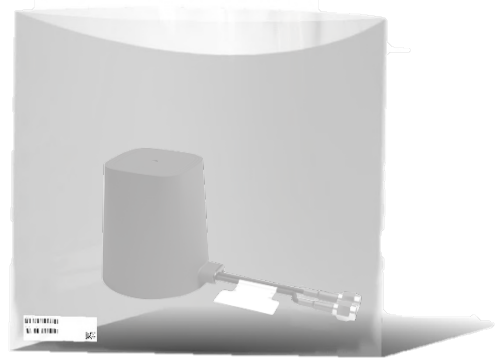

60 PCS / Carton
Dimensions: 430 x 380 x 280mm
Weight: 10.76Kg



5. Antenna Characteristics

5.1 Test Setup

AUT



Vector Network Analyzer

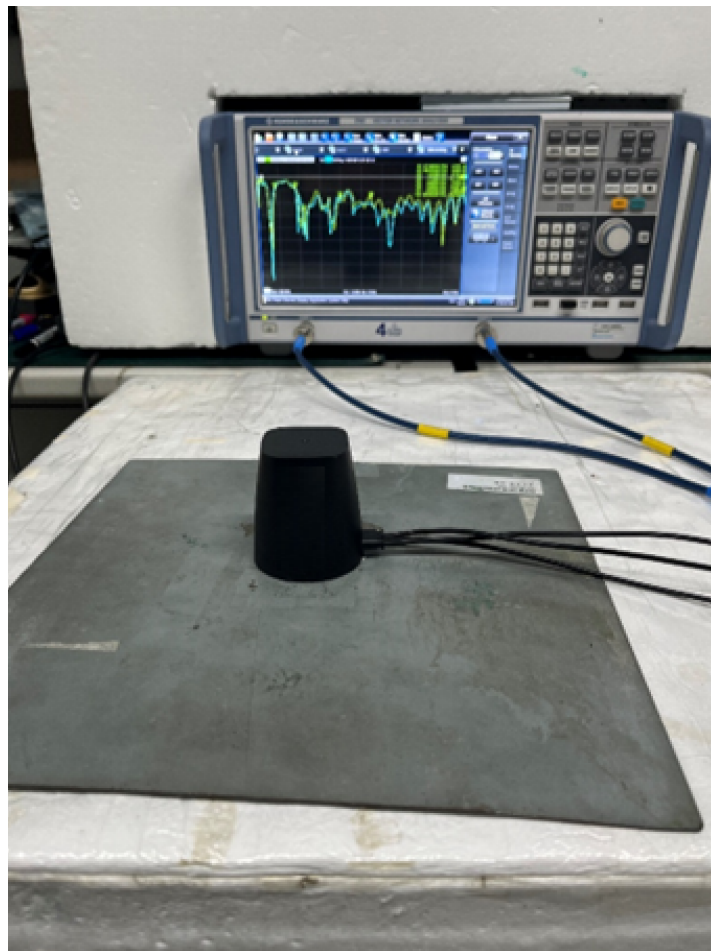

VNA Set-up on 30x30cm Ground Plane

5.2 LTE - Return Loss

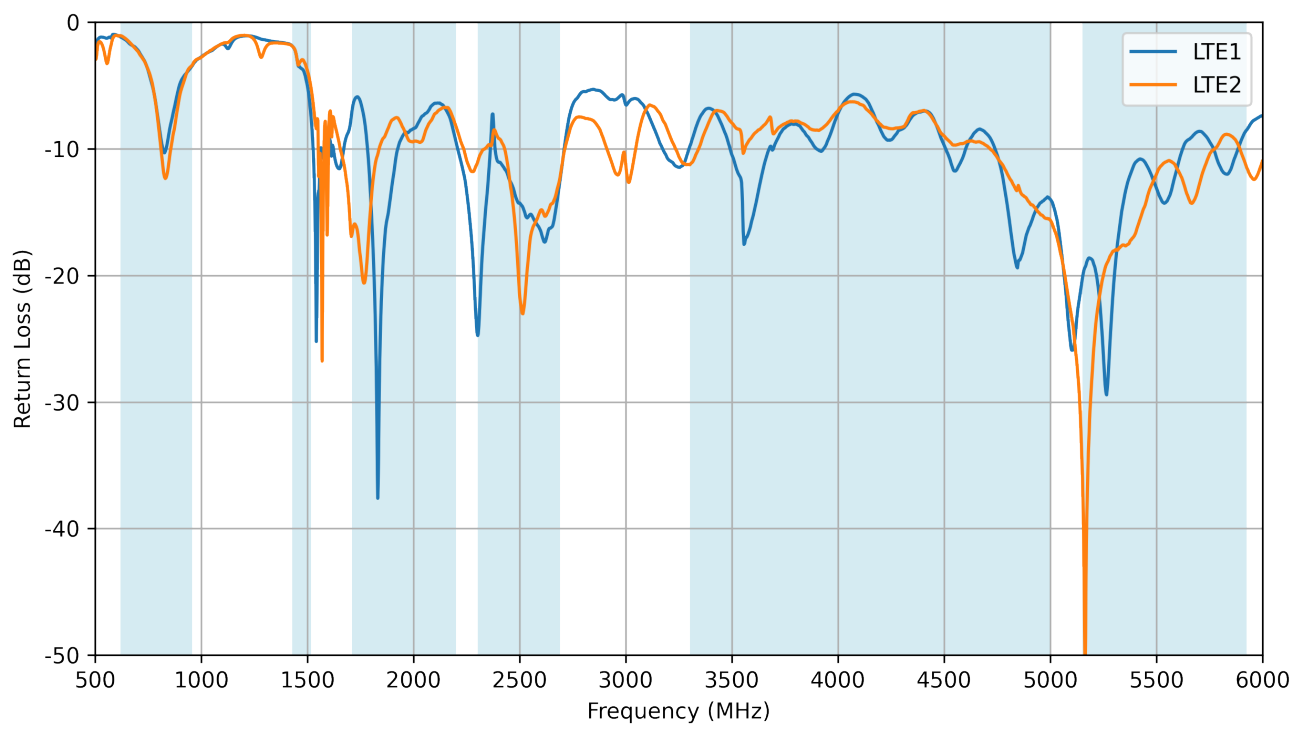

5.3 LTE - VSWR

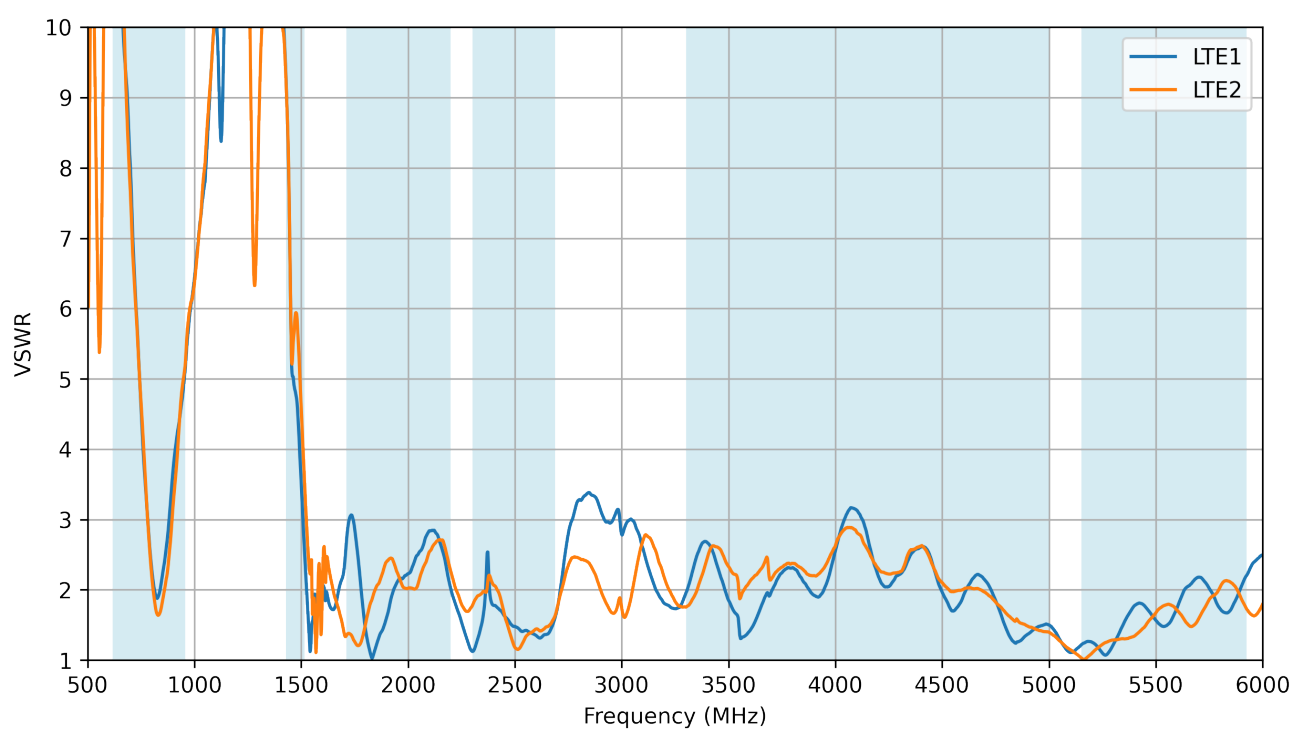

5.4 LTE - Efficiency

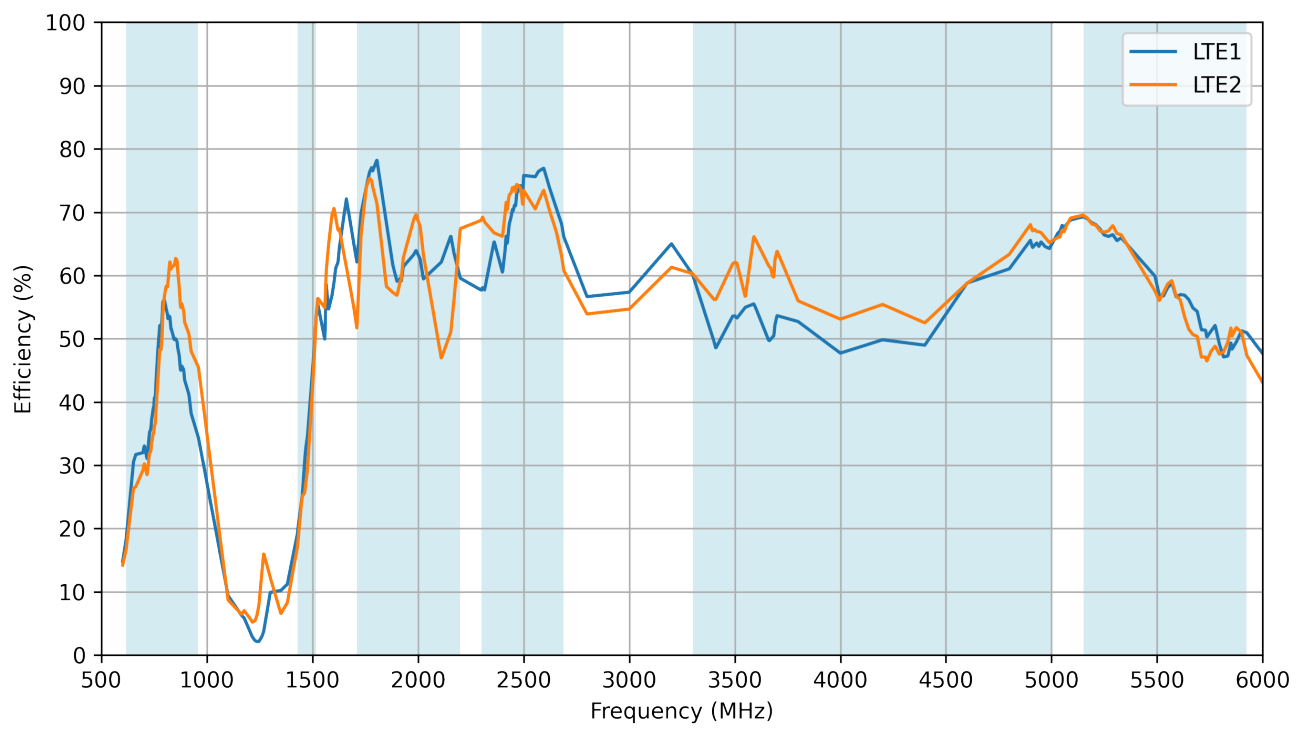

5.5 LTE - Average Gain

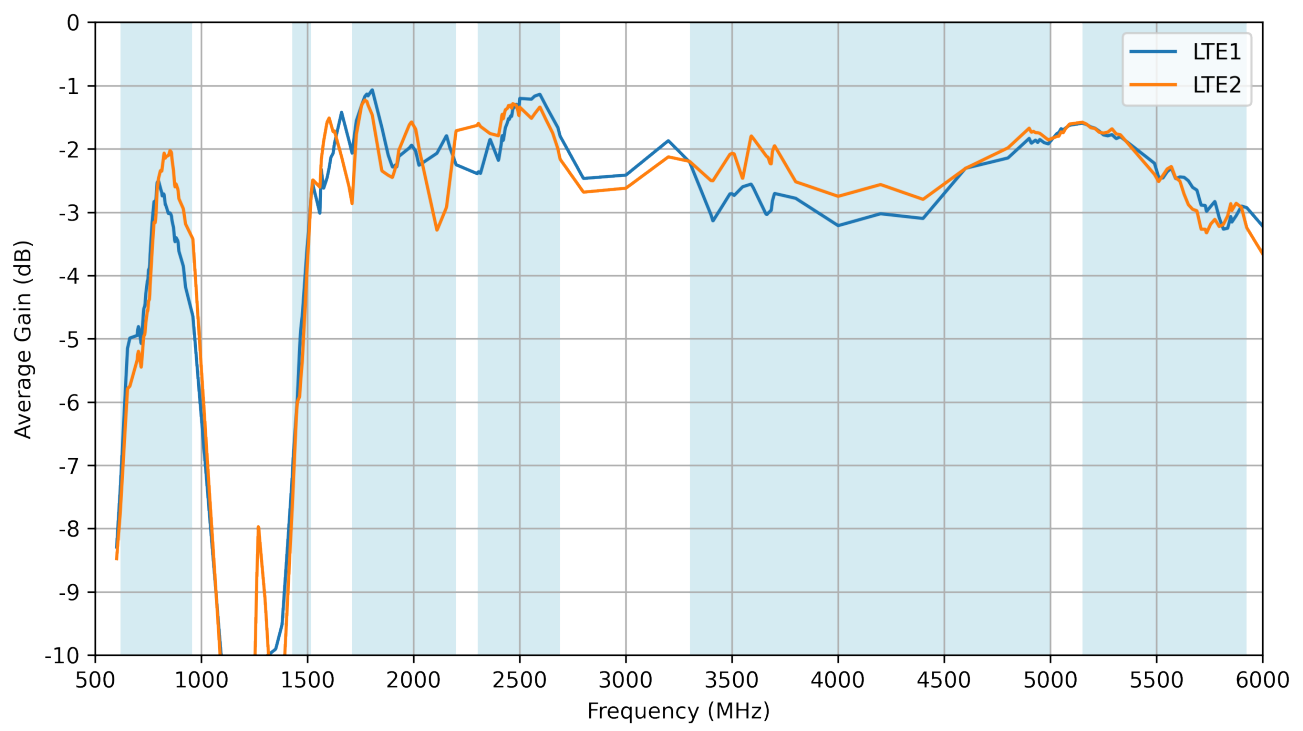

5.6 LTE - Peak Gain

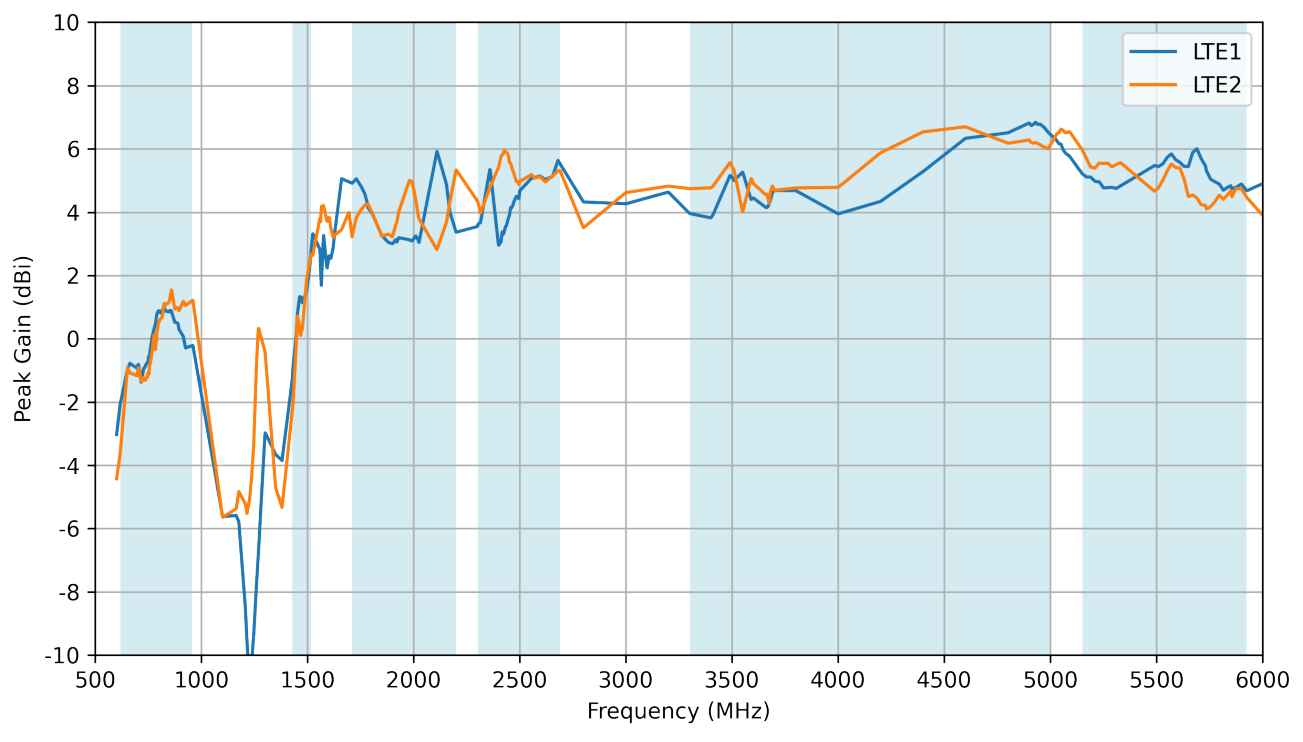

6. Radiation Patterns

6.1 Test Setup

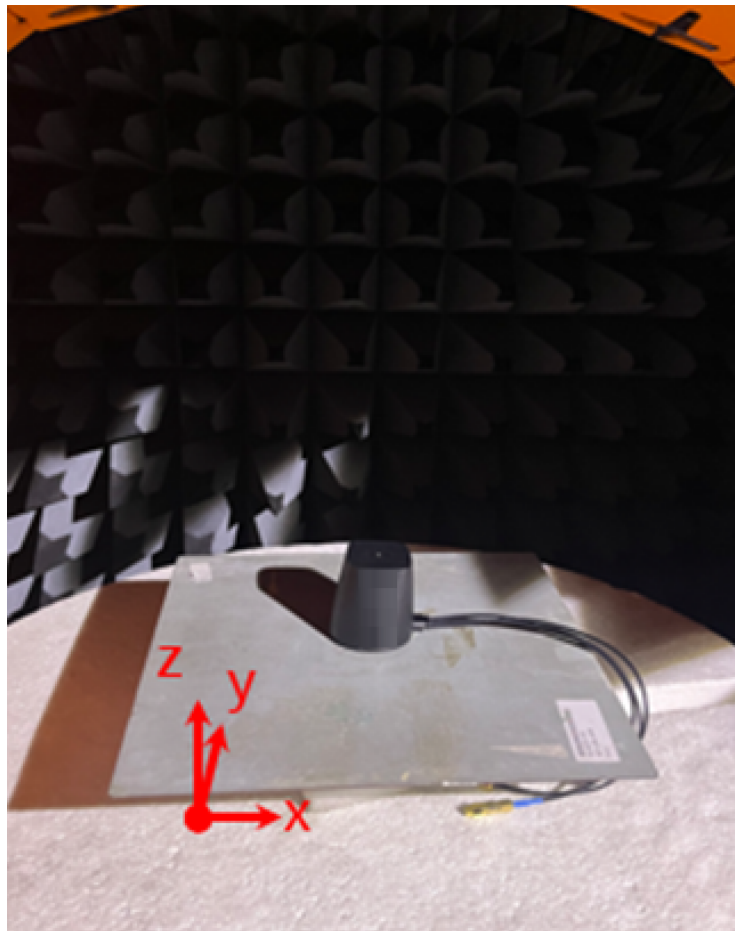
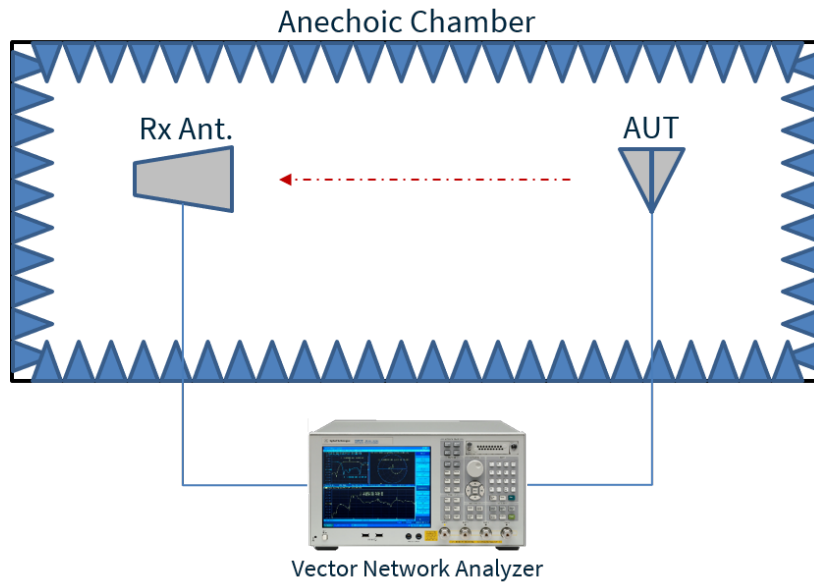

Chamber Set-up on 30x30cm Ground Plane

6.2 LTE1 Patterns at 650 MHz

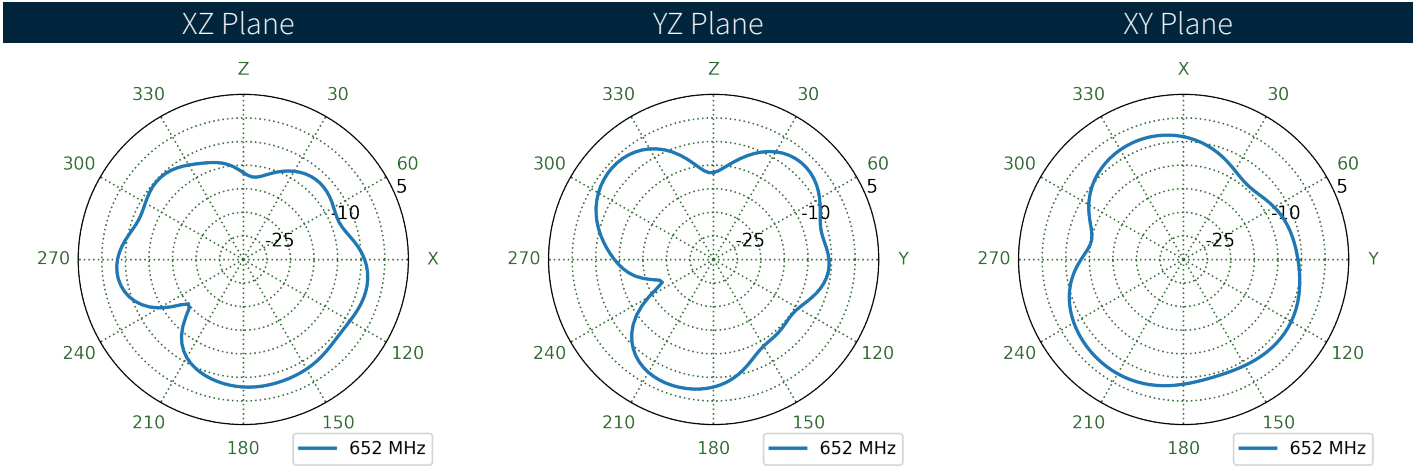
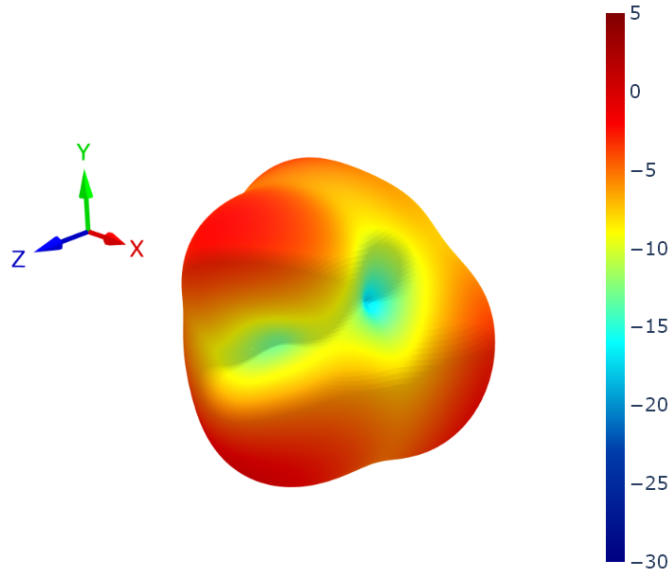

6.3 LTE2 Patterns at 650 MHz

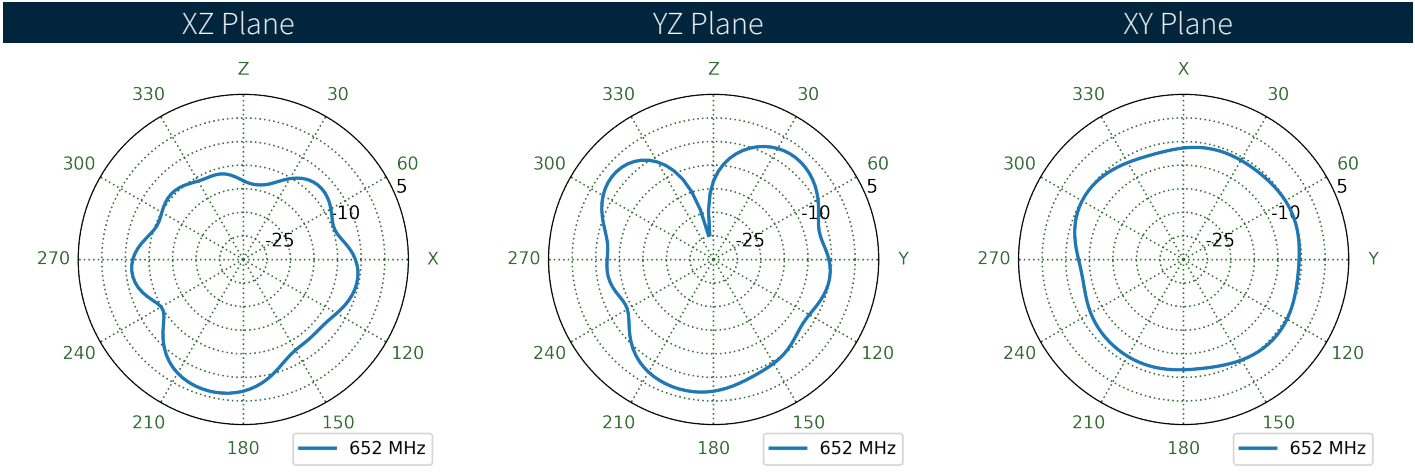
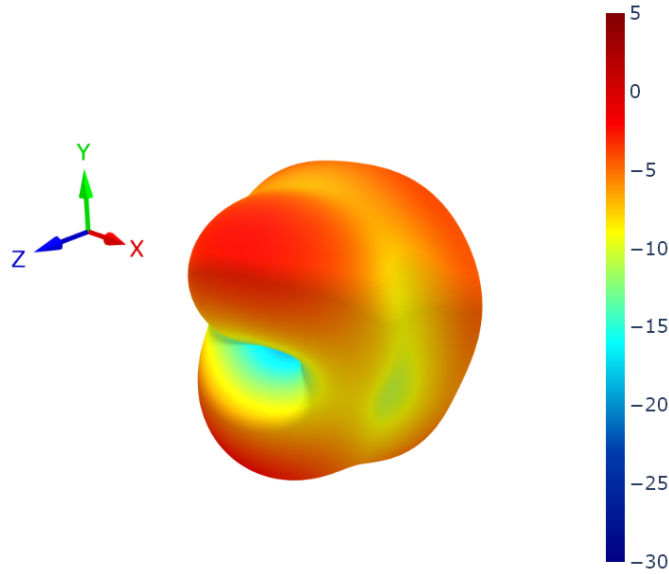

6.4 LTE1 Patterns at 750 MHz

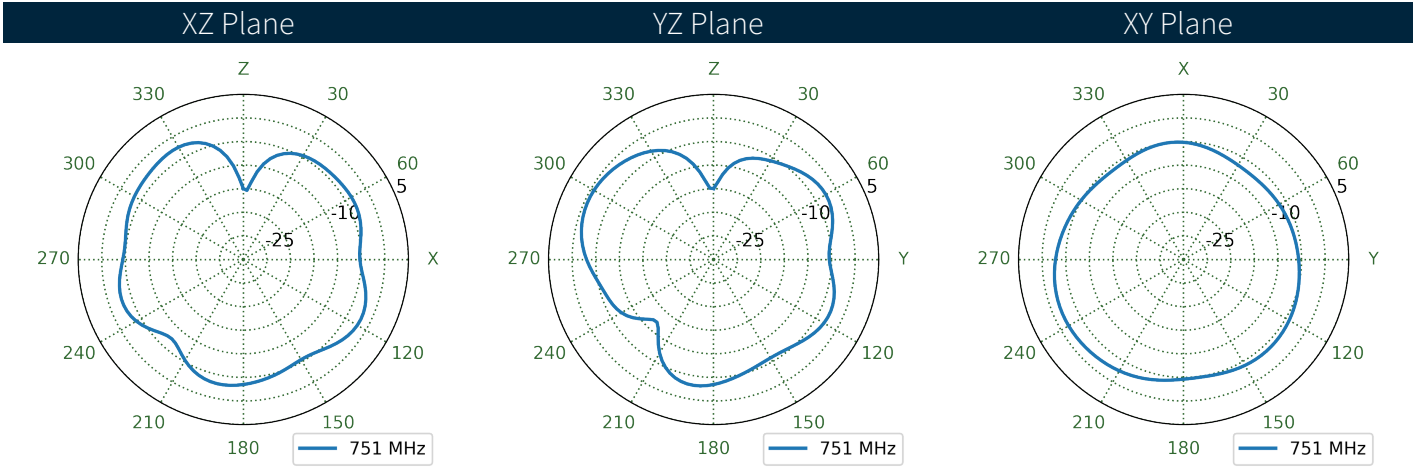
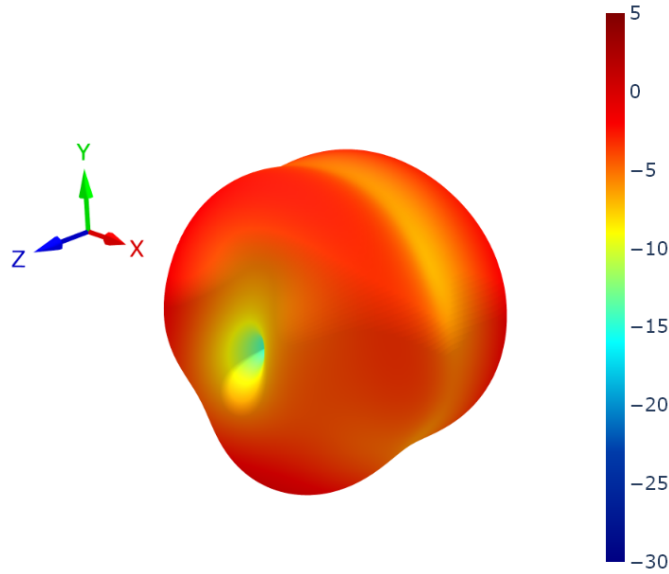

6.5 LTE2 Patterns at 750 MHz

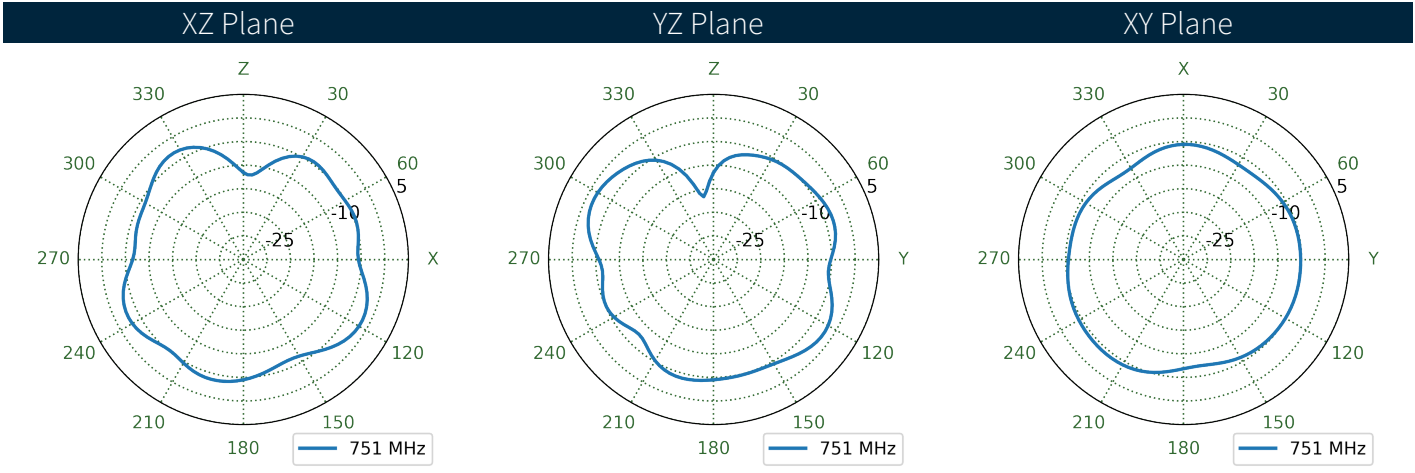
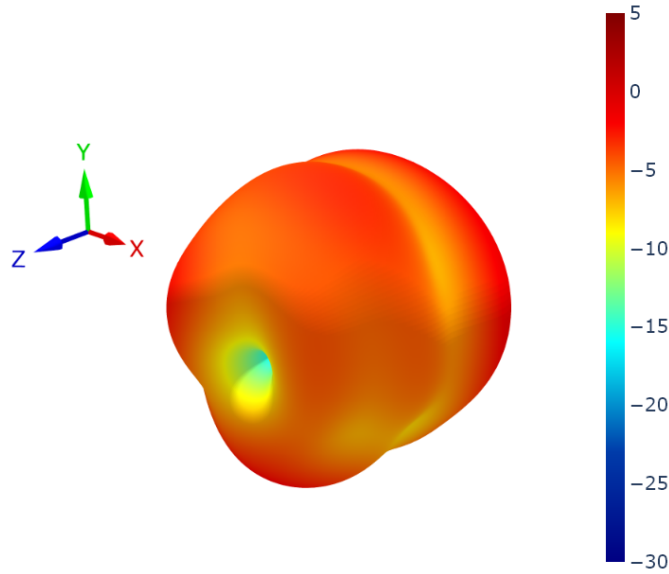

6.6 LTE1 Patterns at 890 MHz

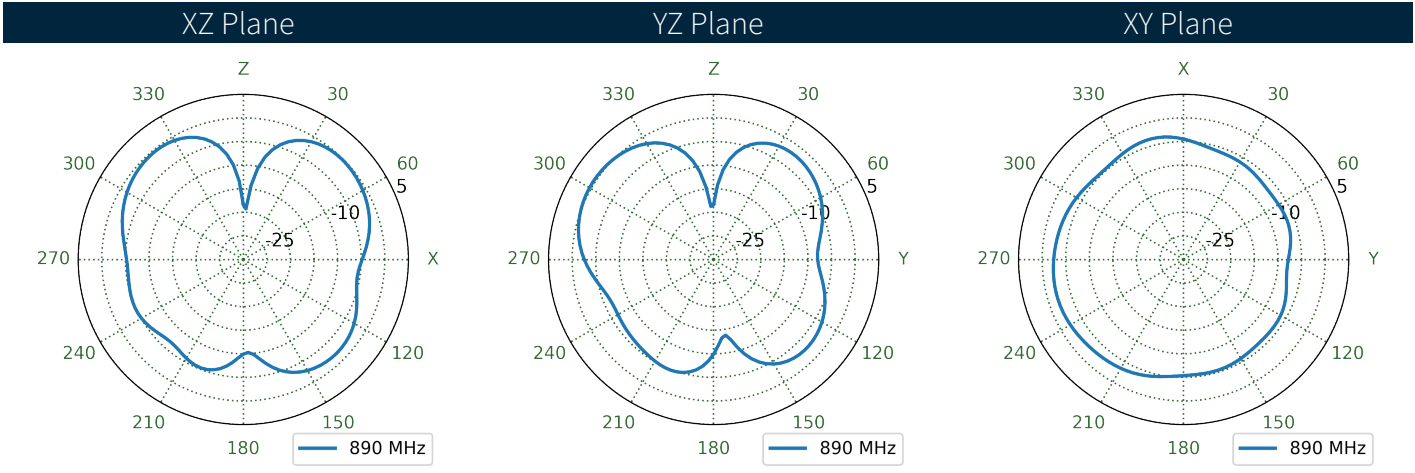
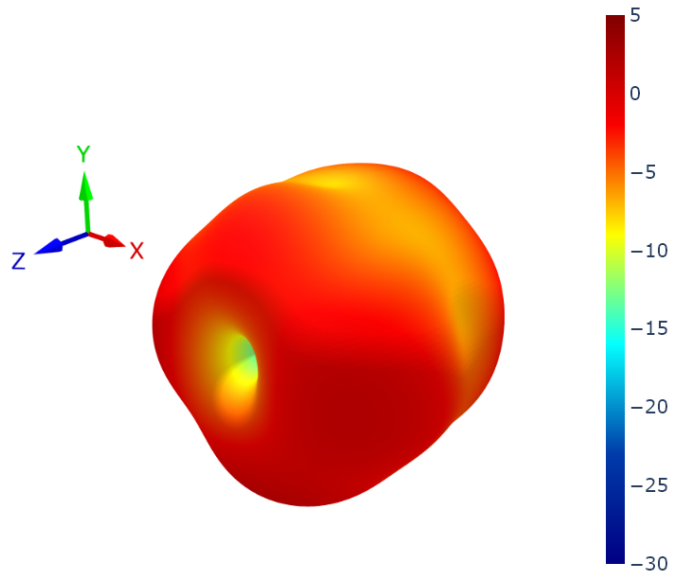

6.7 LTE2 Patterns at 890 MHz

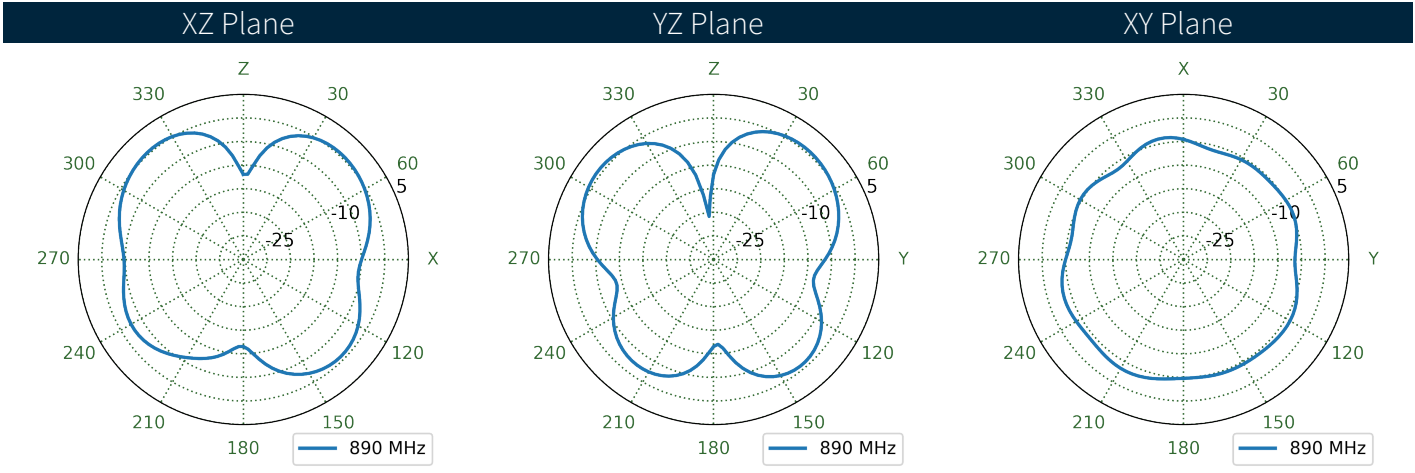
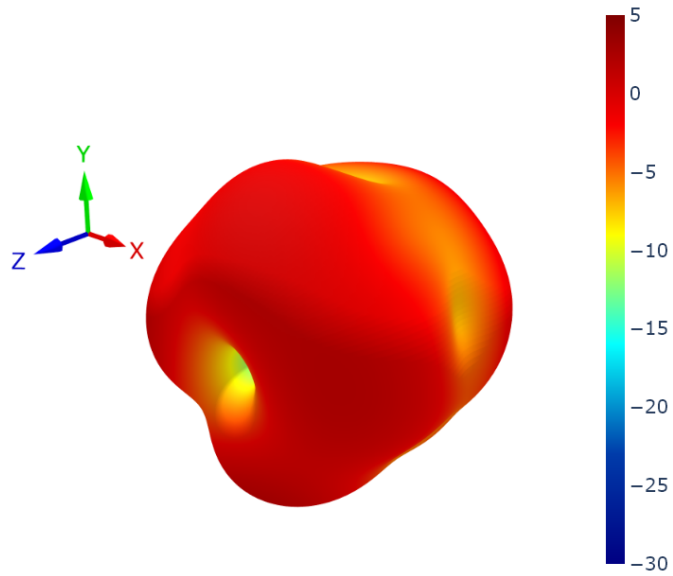

6.8 LTE1 Patterns at 1470 MHz

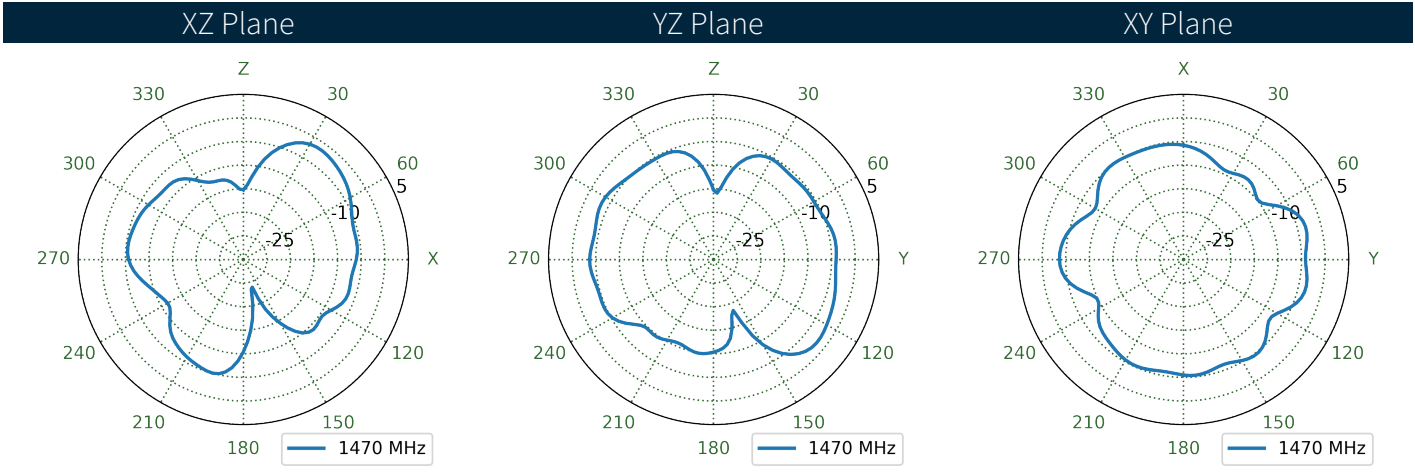
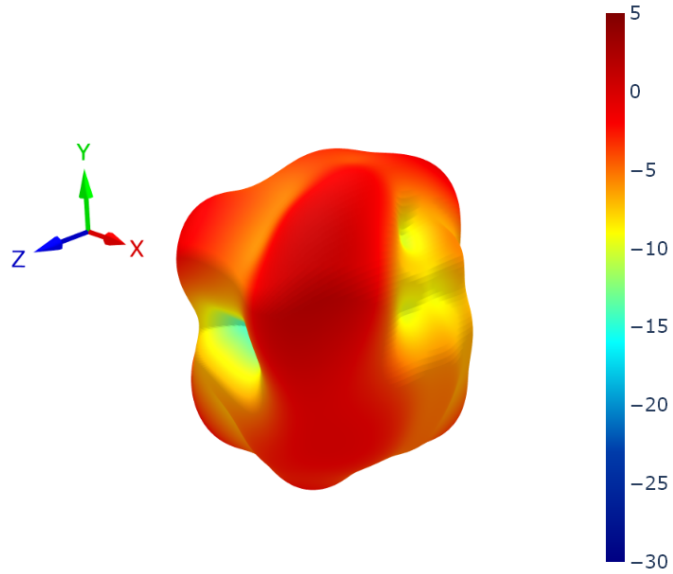

6.9 LTE2 Patterns at 1470 MHz

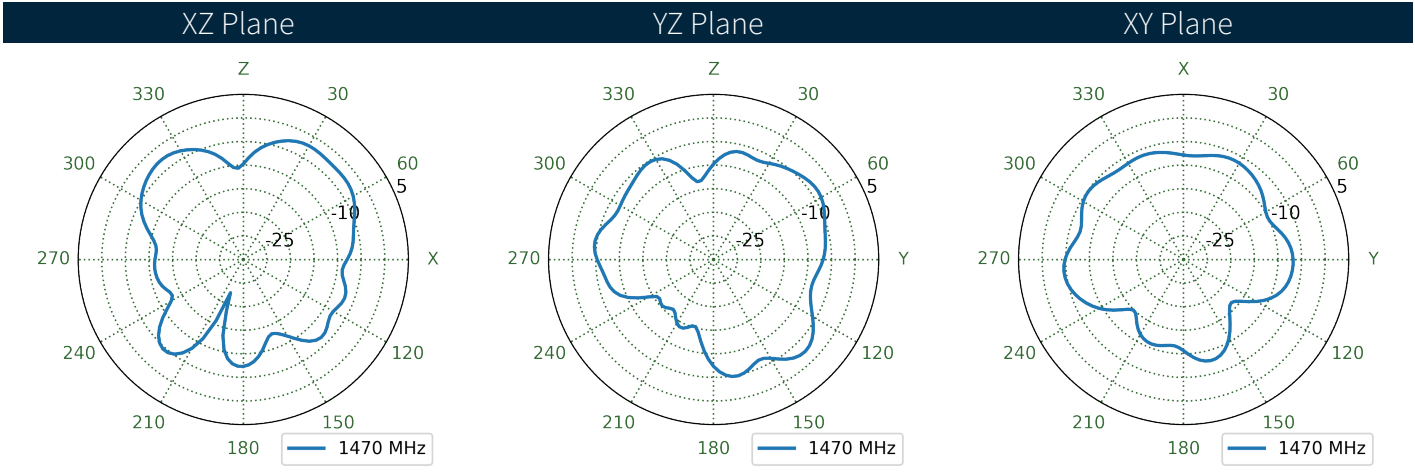
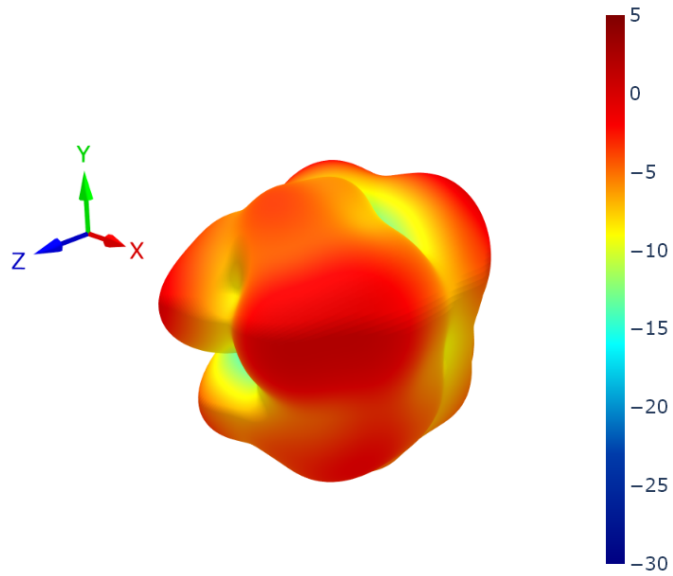

6.10 LTE1 Patterns at 1805 MHz

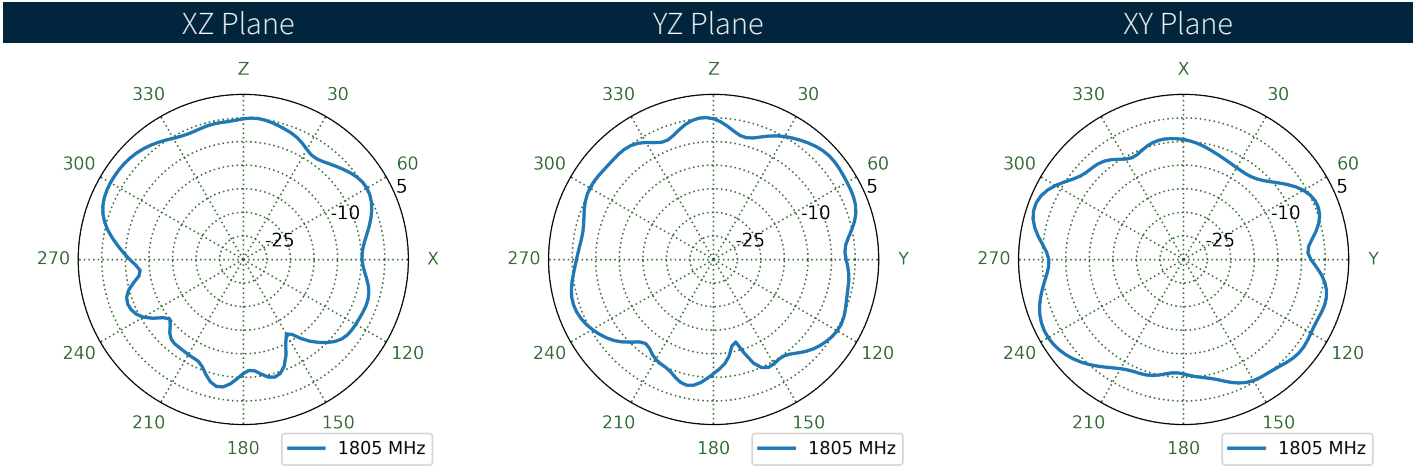
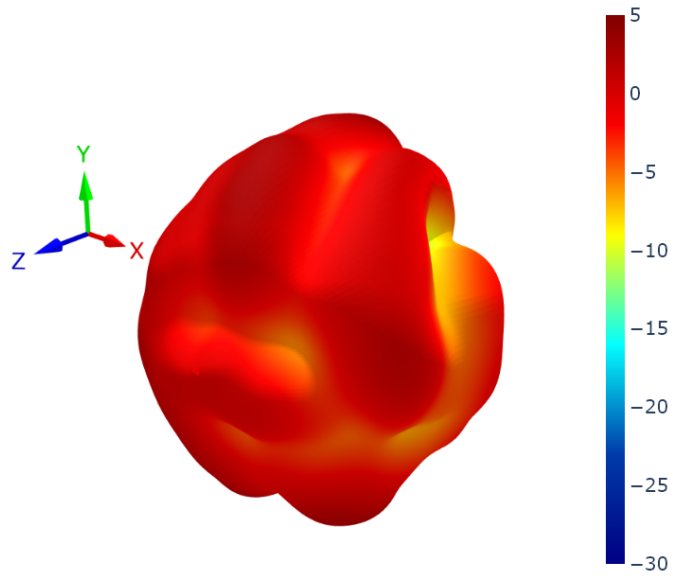

6.11 LTE2 Patterns at 1805 MHz

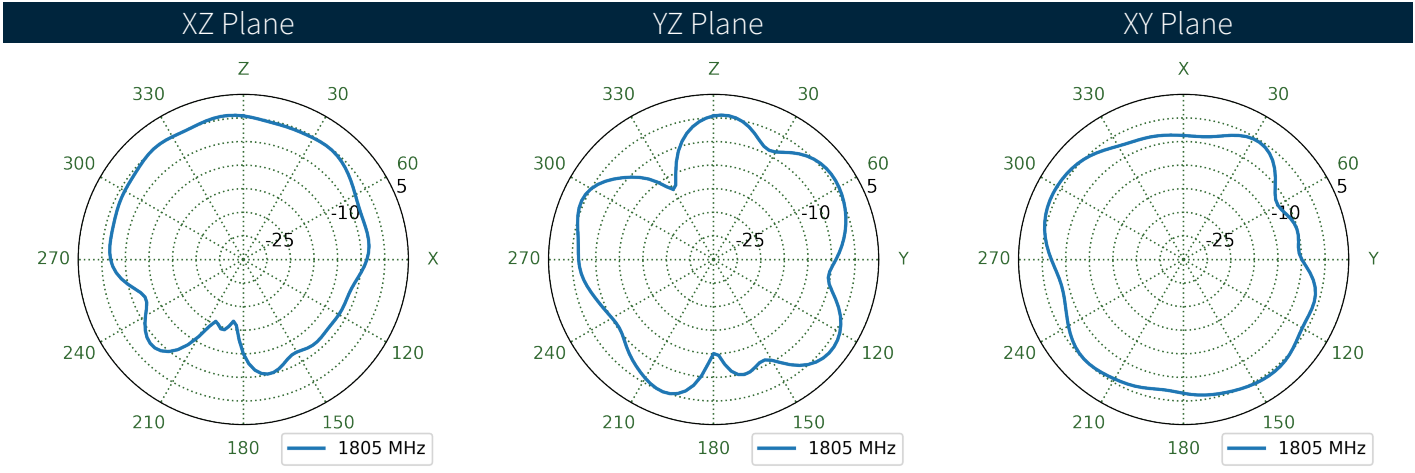
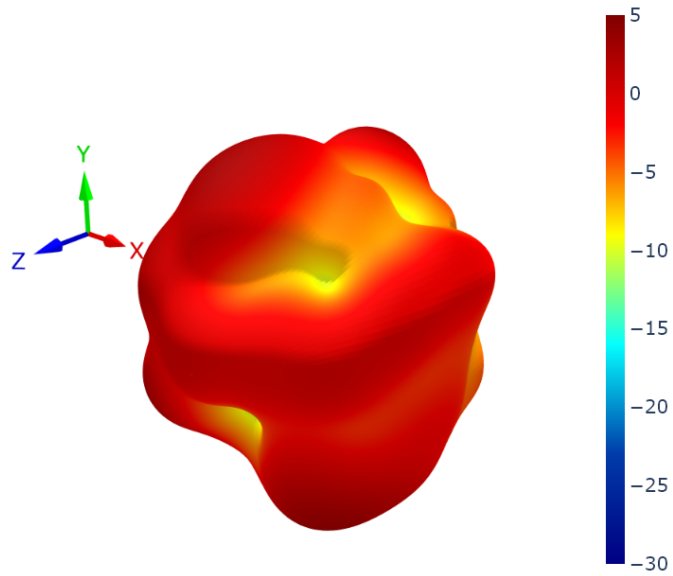

6.12 LTE1 Patterns at 1920 MHz

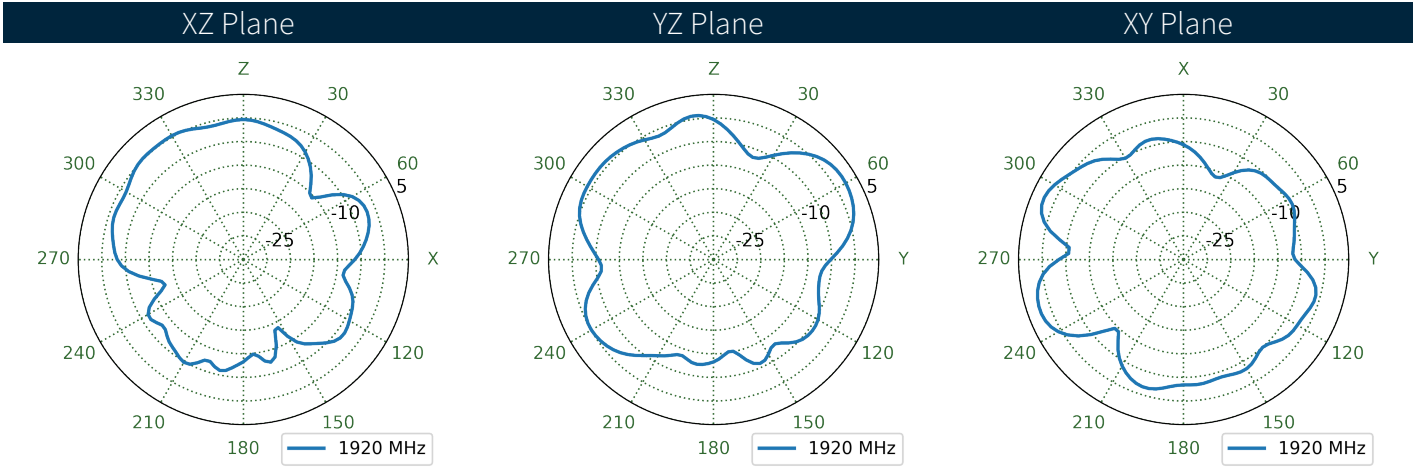
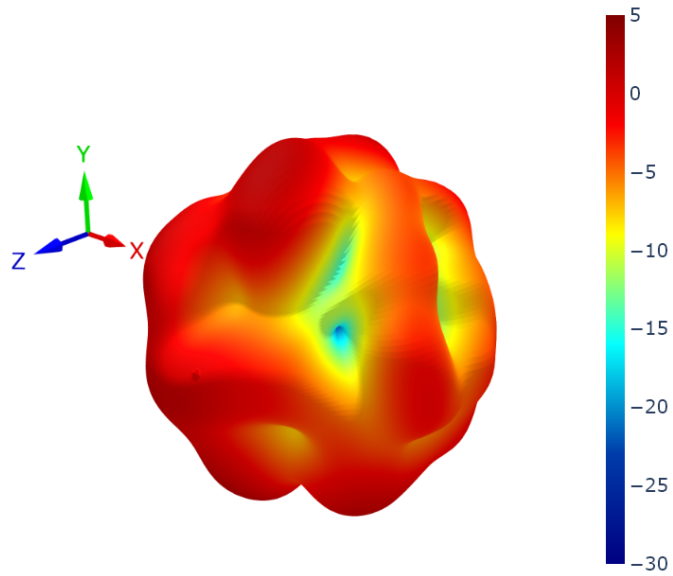

6.13 LTE2 Patterns at 1920 MHz

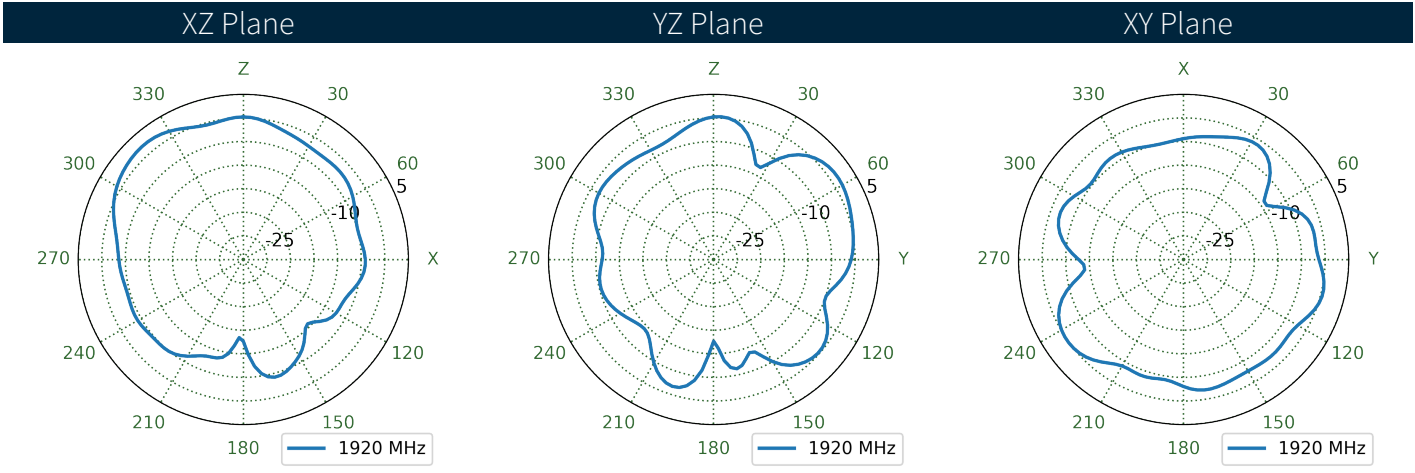
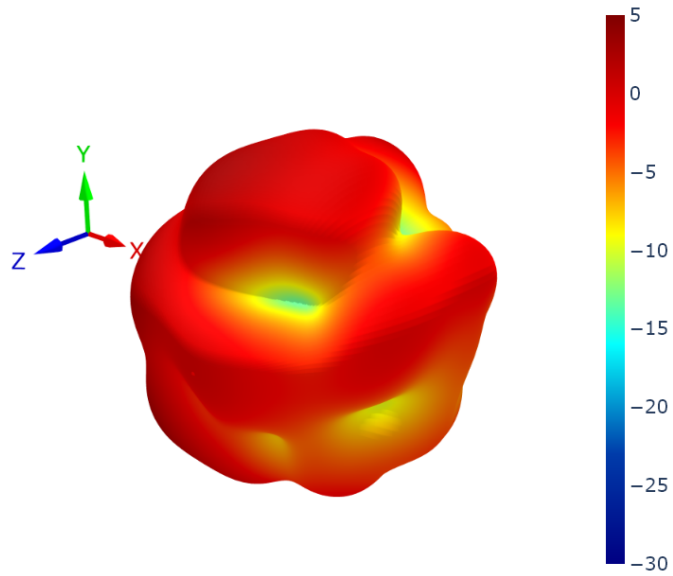

6.14 LTE1 Patterns at 1990 MHz

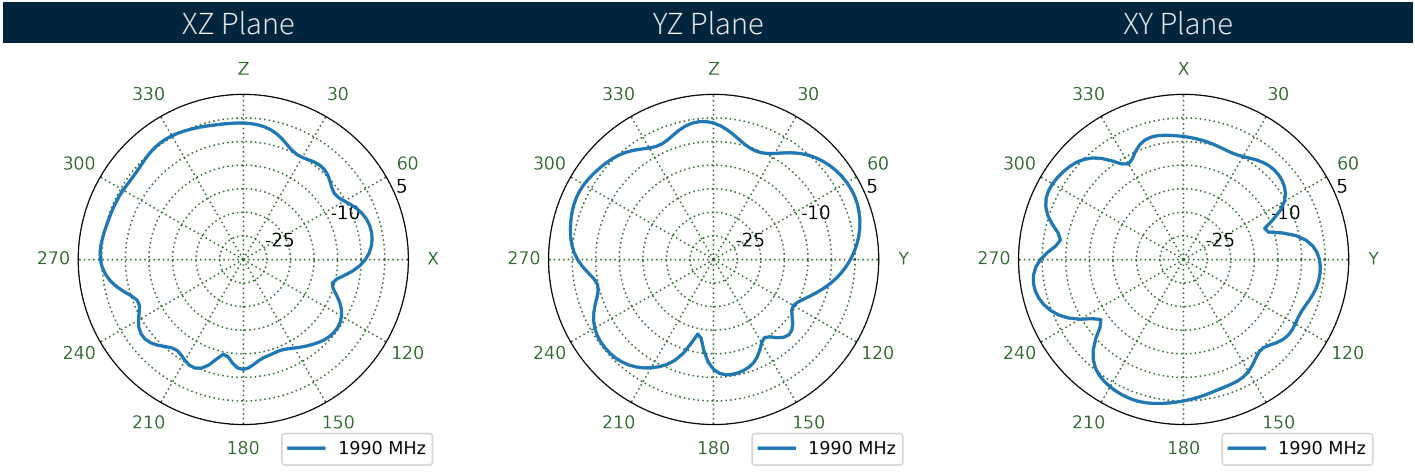
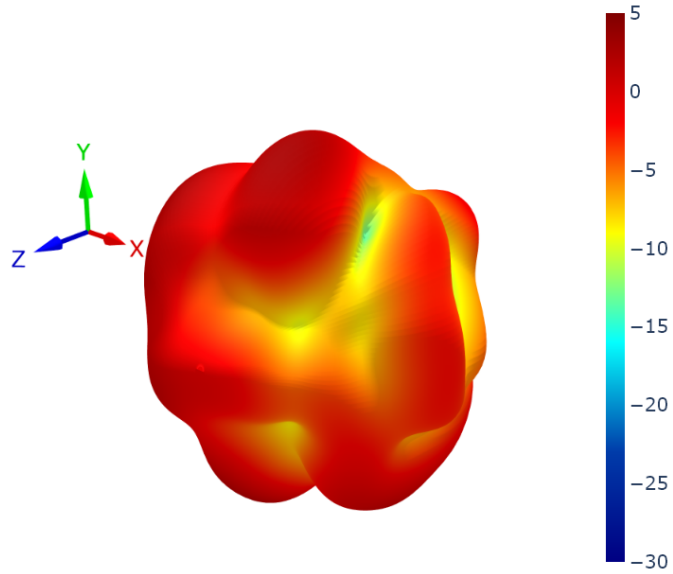

6.15 LTE2 Patterns at 1990 MHz

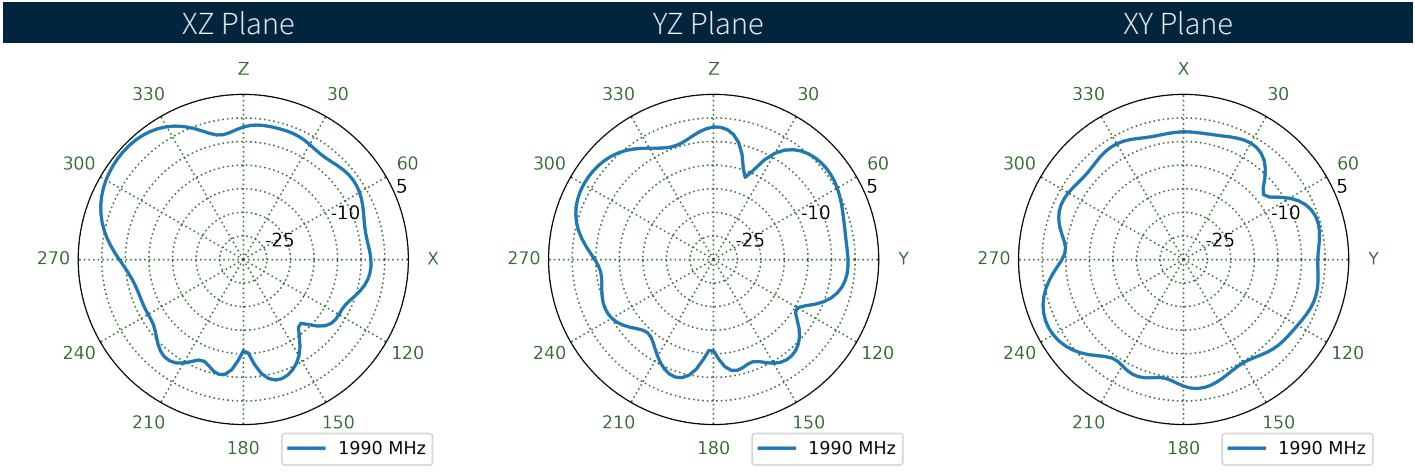
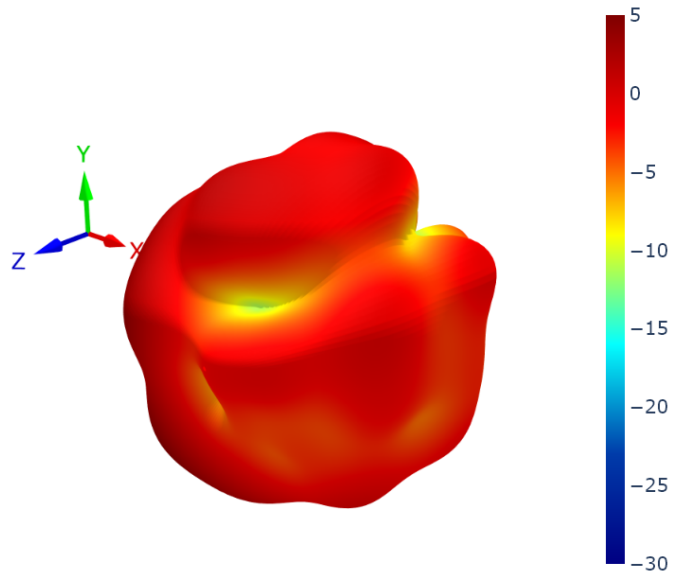

6.16 LTE1 Patterns at 2360 MHz

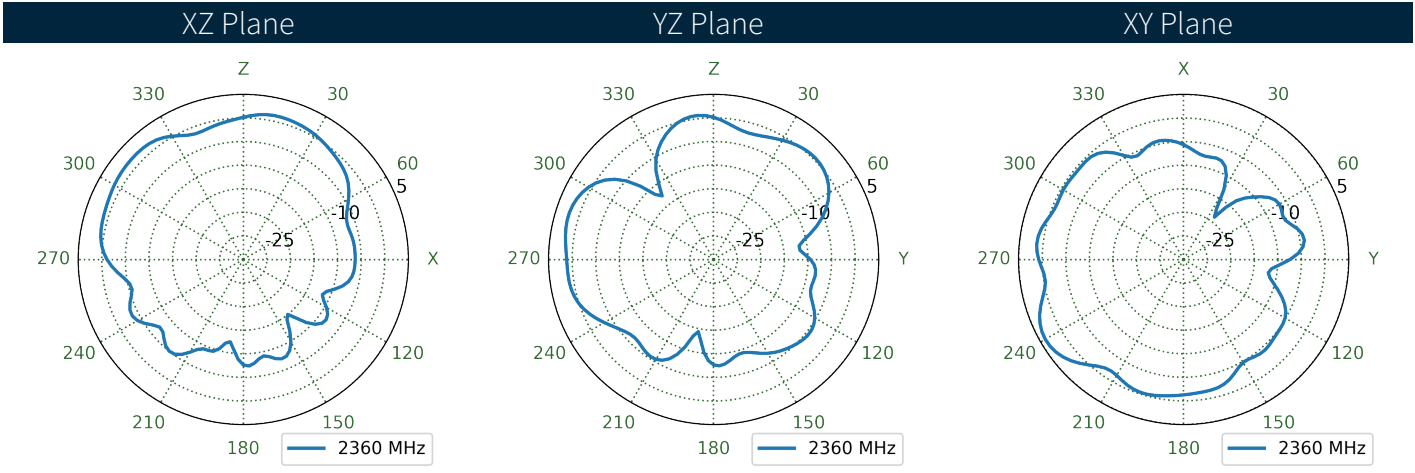
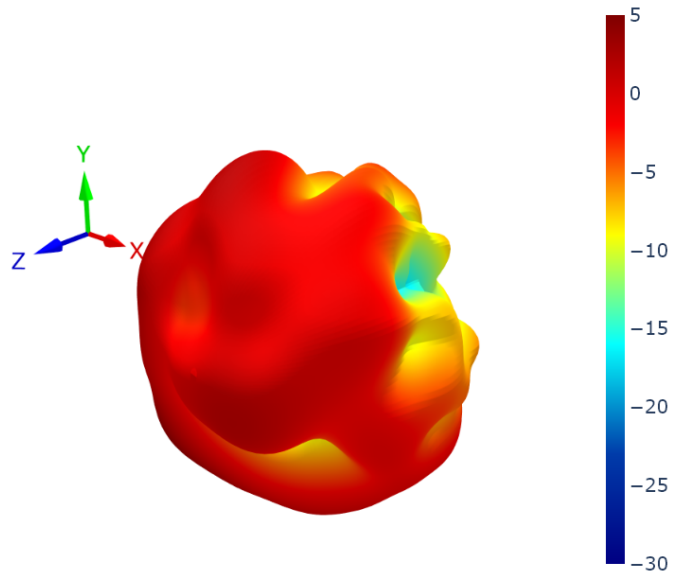

6.17 LTE2 Patterns at 2360 MHz

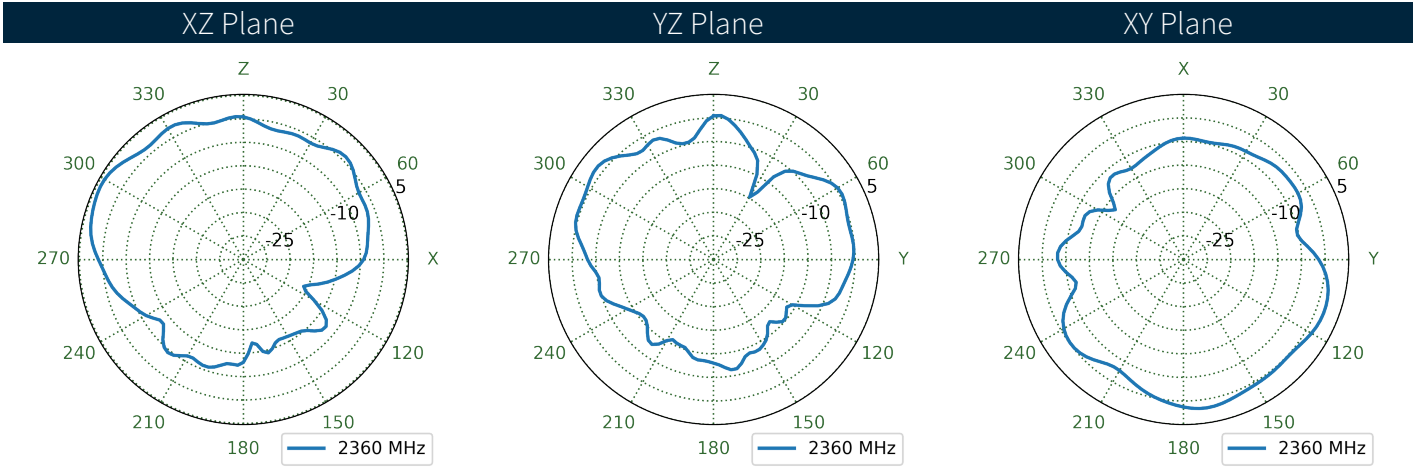
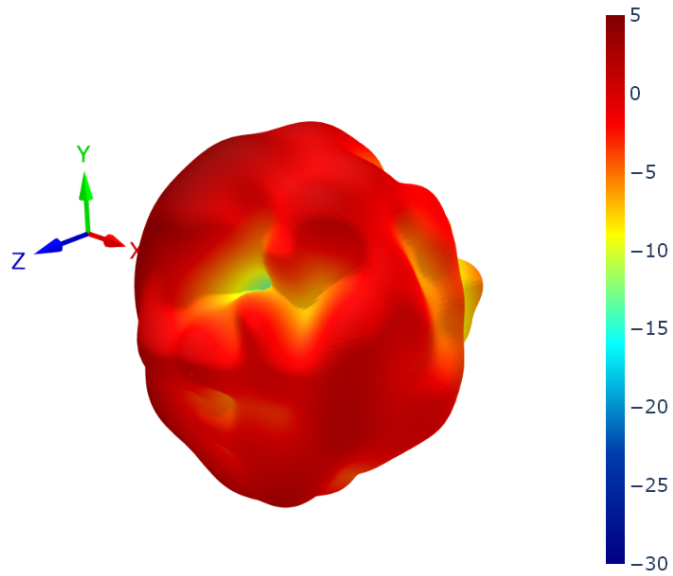

6.18 LTE1 Patterns at 2595 MHz

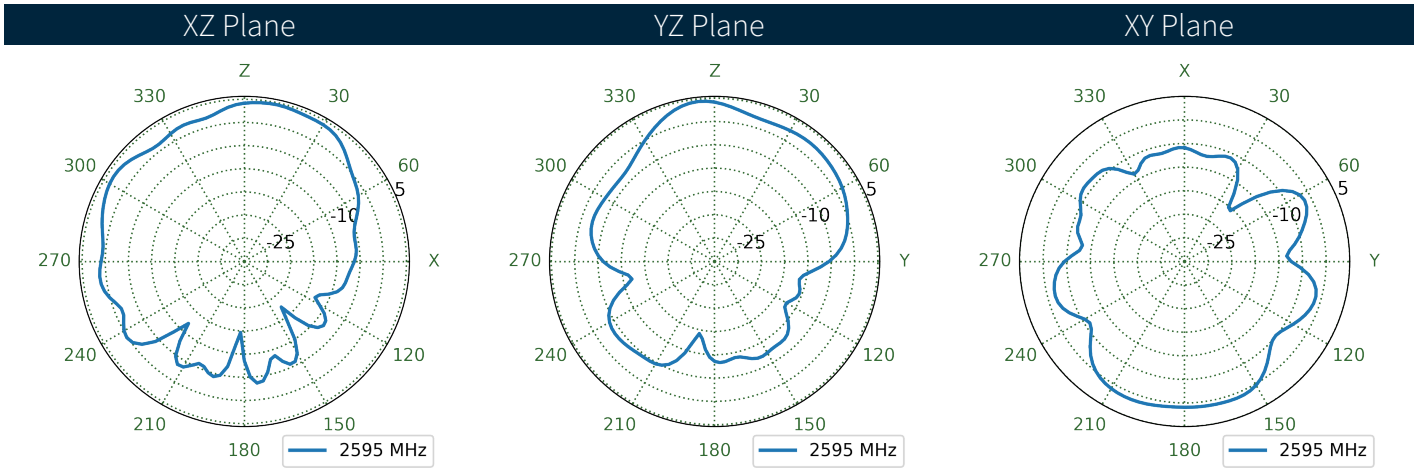
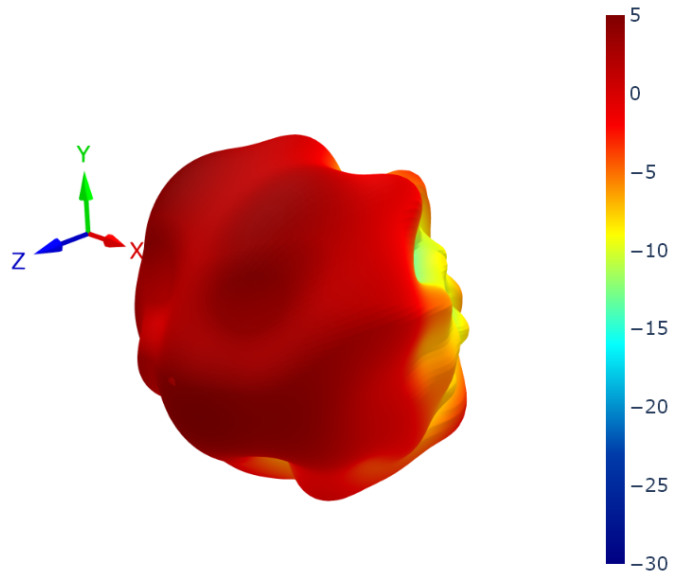

6.19 LTE2 Patterns at 2595 MHz

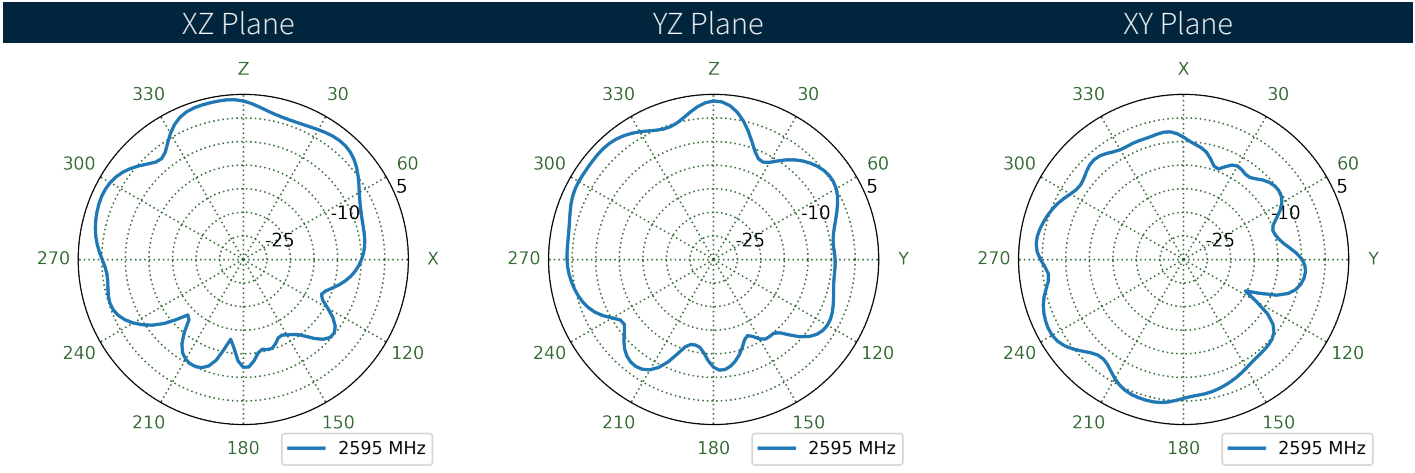
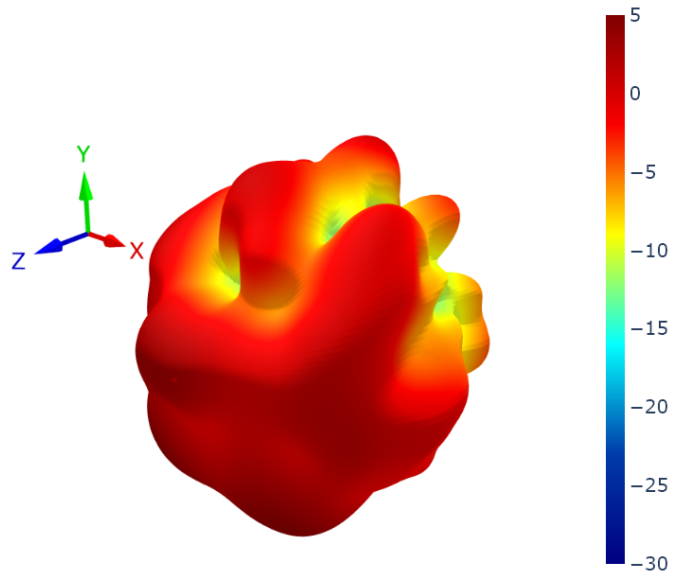

6.20 LTE1 Patterns at 3550 MHz

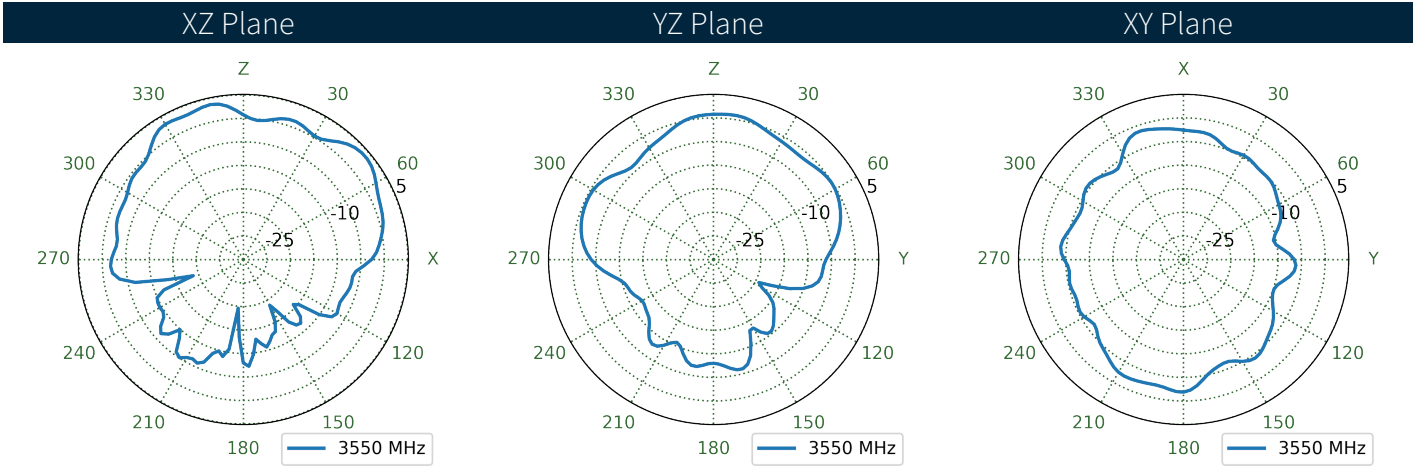
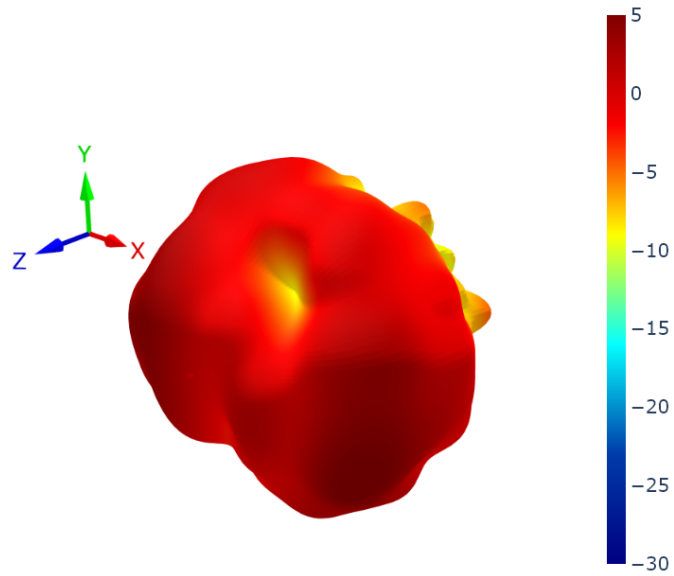

6.21 LTE2 Patterns at 3550 MHz

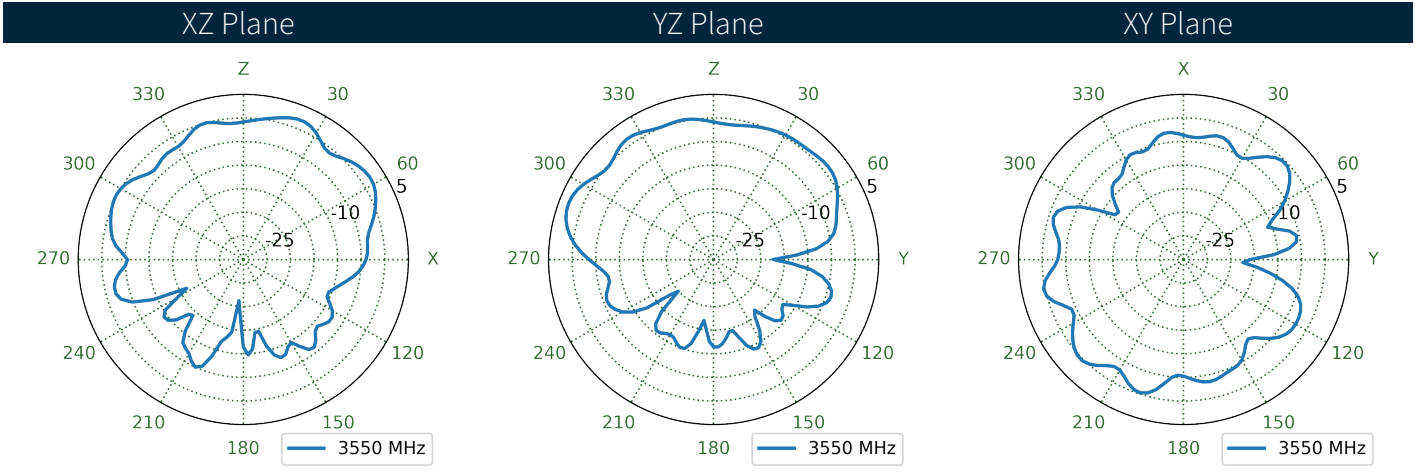
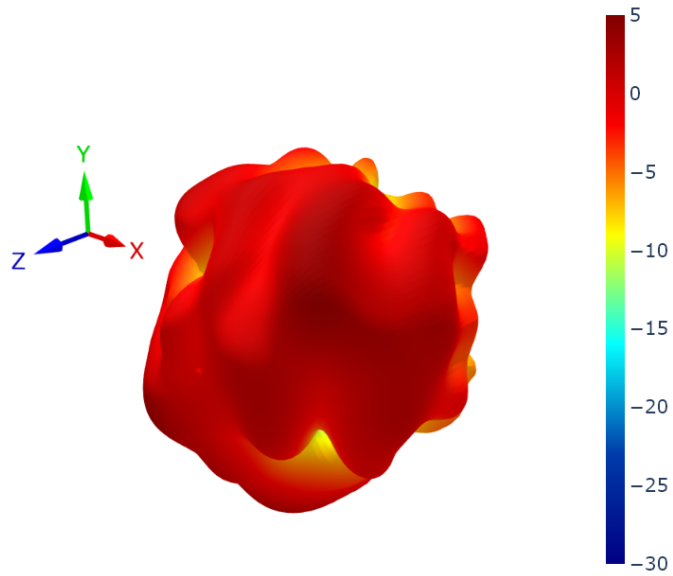

6.22 LTE1 Patterns at 4600 MHz

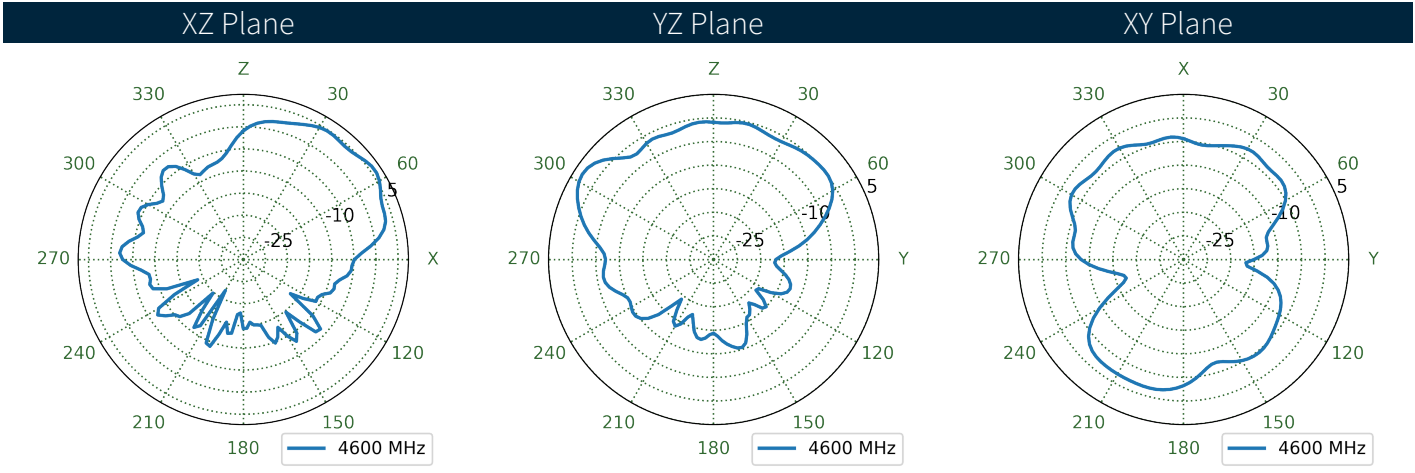
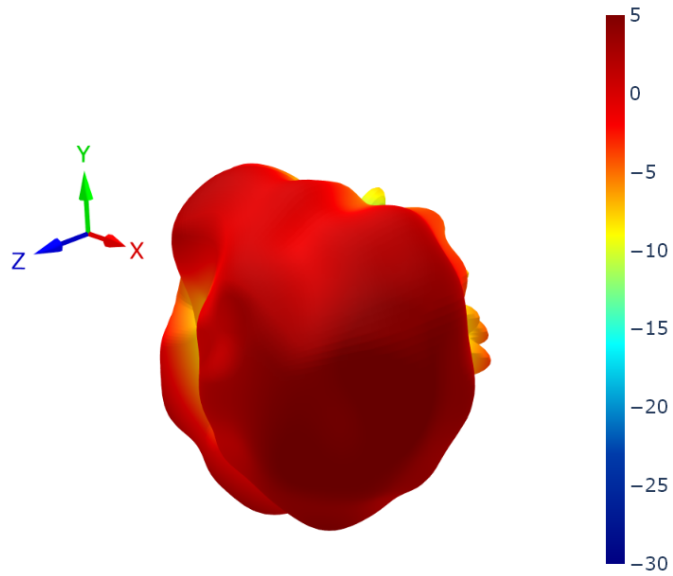

6.23 LTE2 Patterns at 4600 MHz

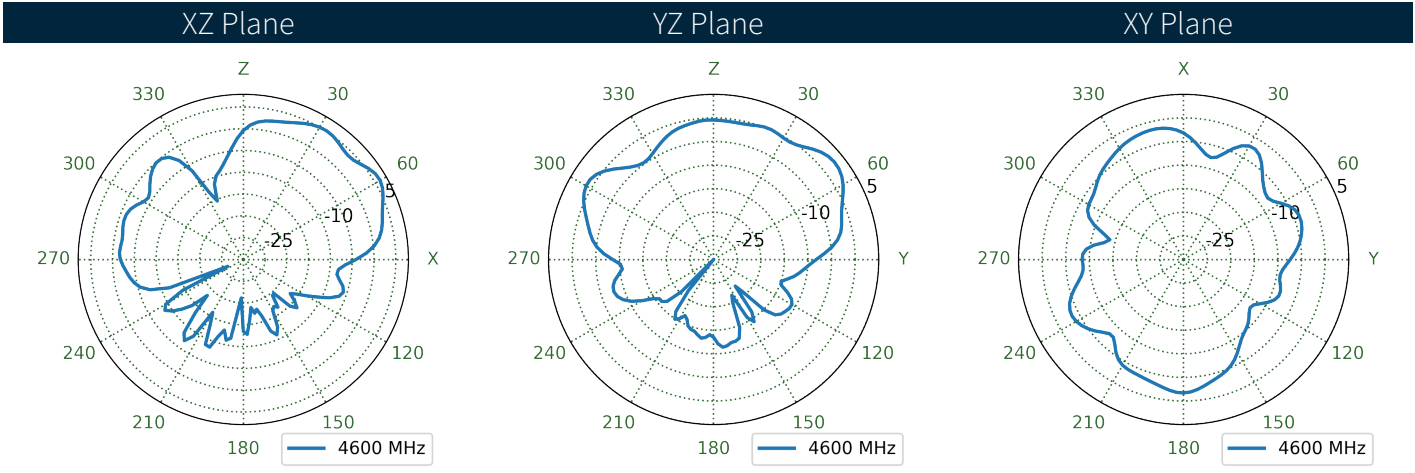
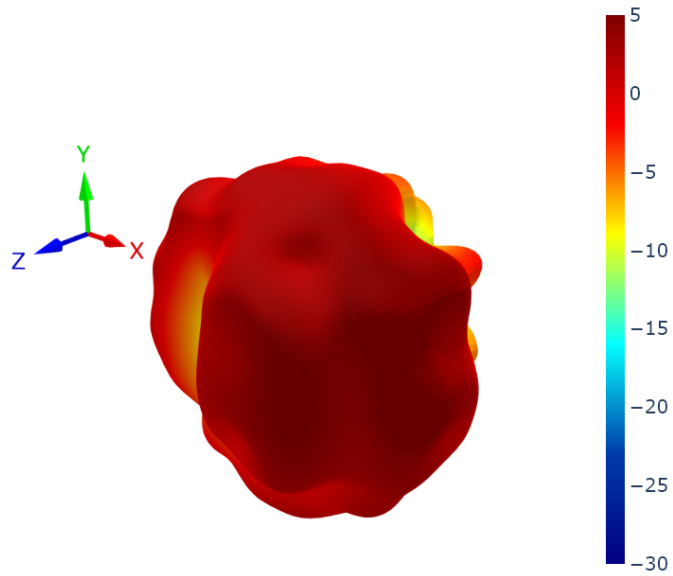

6.24 LTE1 Patterns at 4800 MHz

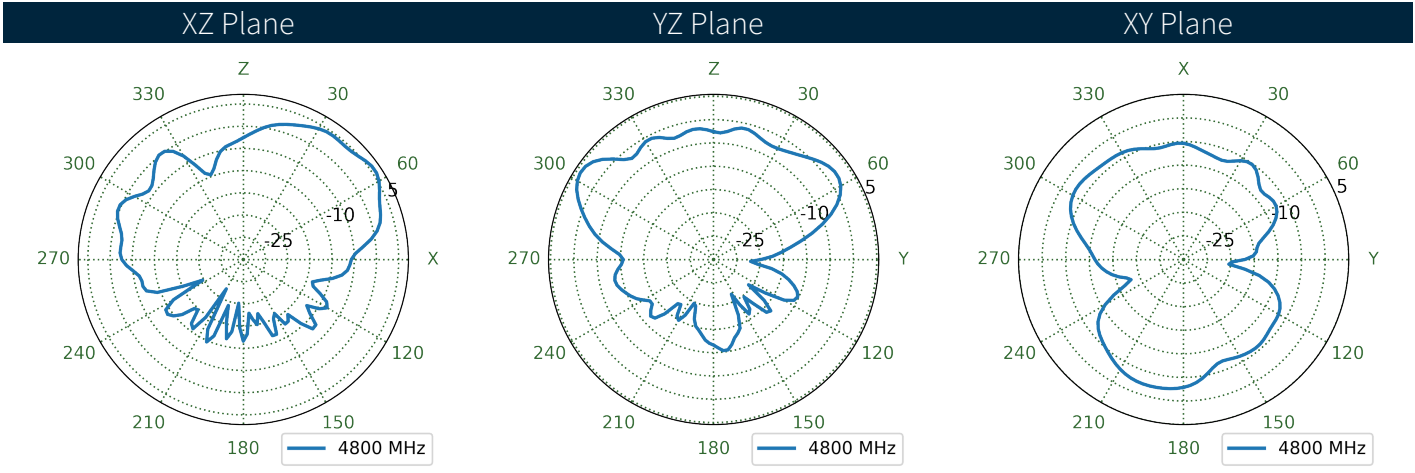
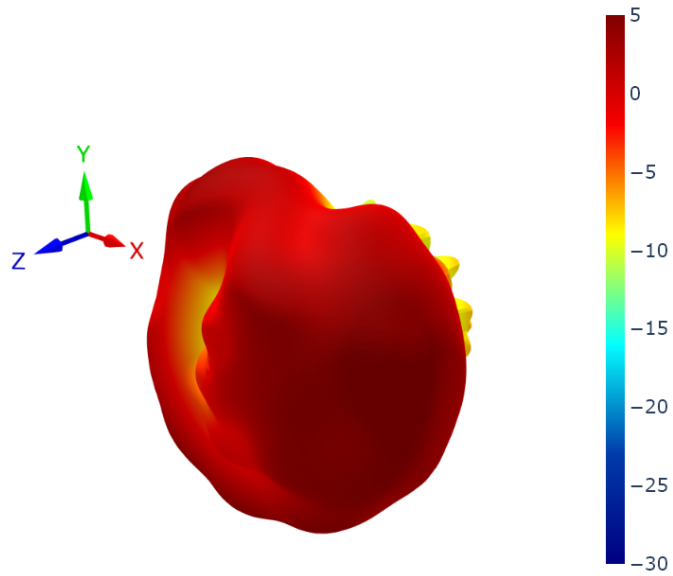

6.25 LTE2 Patterns at 4800 MHz

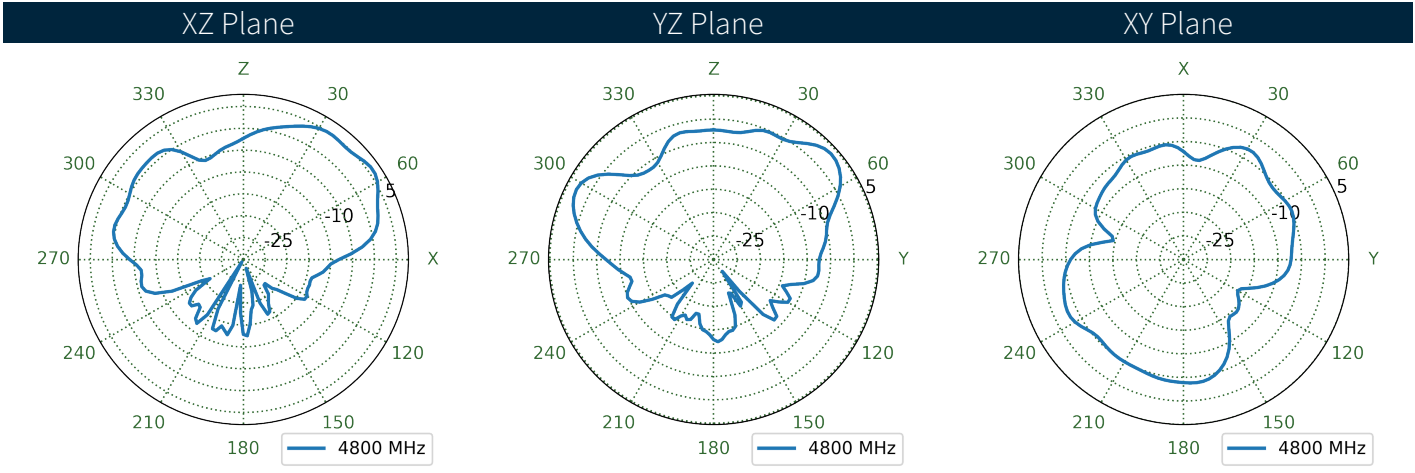
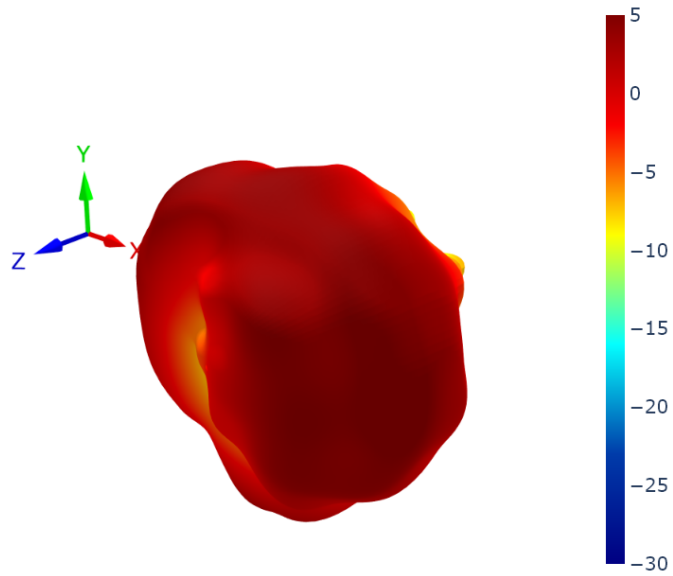

6.26 LTE1 Patterns at 5530 MHz

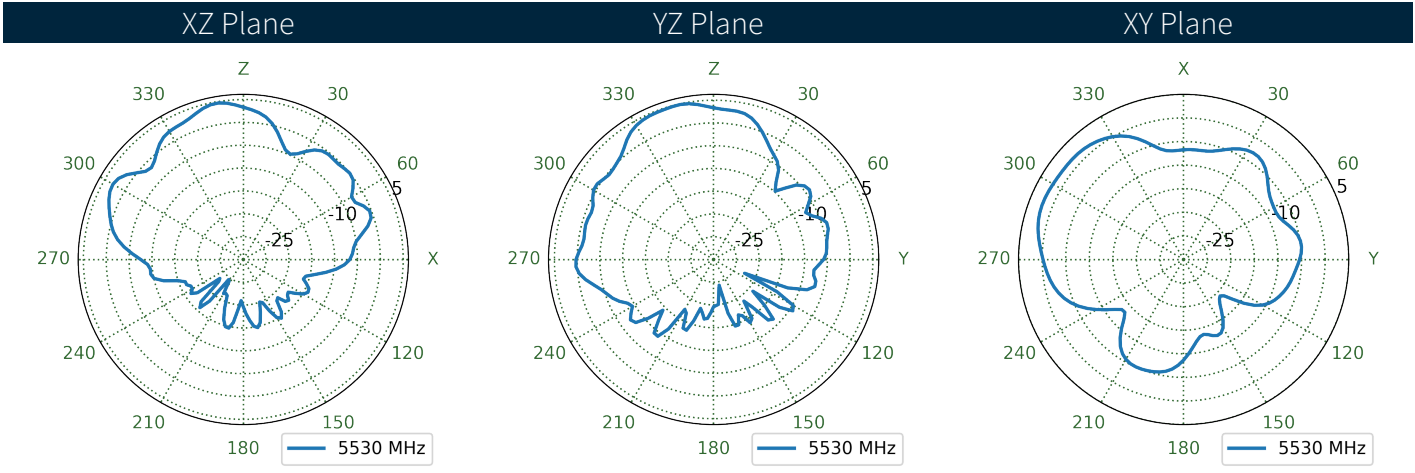
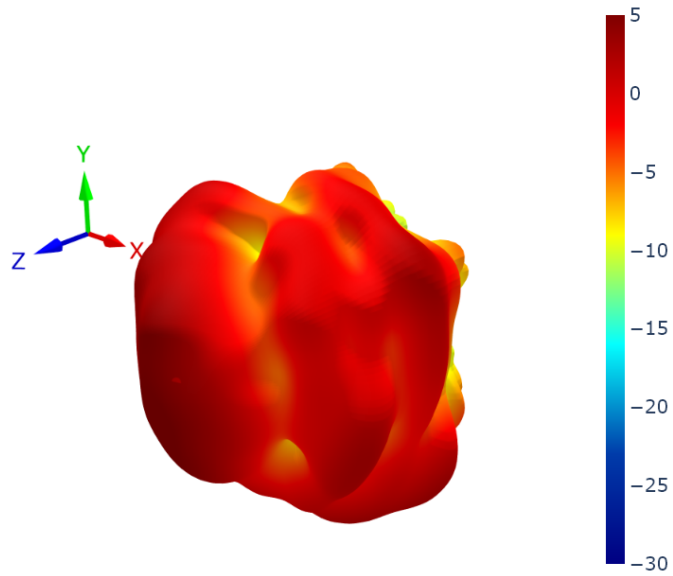

6.27 LTE2 Patterns at 5530 MHz

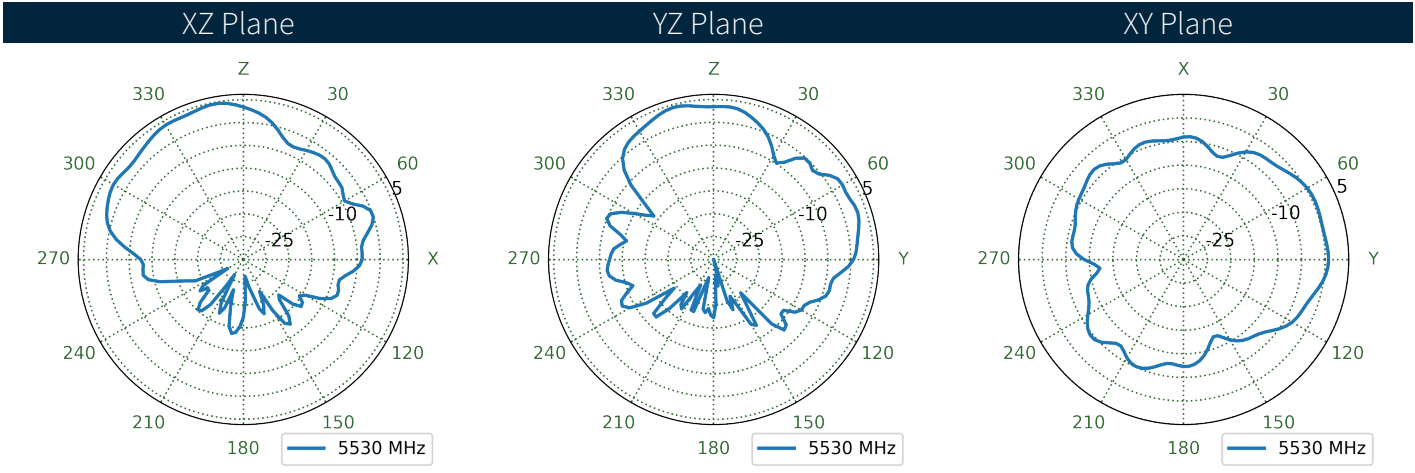
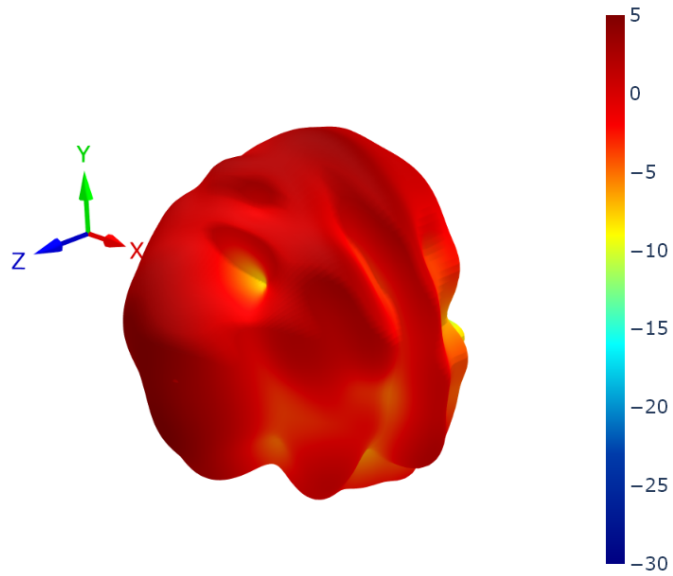

Changelog for the datasheet

SPE-24-8-220 – MA342.W.BI.001

Revision: A (Original First Release)

Date: 2024-09-11

Notes: Initial Release

Author: Cesar Sousa

Previous Revisions

