



TAOGLAS®



Datasheet

SXP.18.4.A.02

Part No:
SXP.18.4.A.02

Description:

2320 ~ 2345 MHz SDARS 18mm Patch Antenna
(Satellite Digital Audio Radio System)

Features:

18*18*4mm Ceramic Patch
Excellent Efficiency: 87%
High Gain (Up to 9.5dBic at Zenith)
Optimized LHCP Radiation Pattern
Pin & Adhesive Mounting
Manufactured in an IATF16949 Approved Facility
RoHS & REACH Compliant

1. Introduction	3
2. Specifications	4
3. Antenna Characteristics	5
4. 2D Radiation Patterns	8
5. 3D Radiation Patterns	10
6. Mechanical Drawing	11
7. Footprint	12
8. Packaging	13
<hr/>	
Changelog	14

Taoglas makes no warranties based on the accuracy or completeness of the contents of this document and reserves the right to make changes to specifications and product descriptions at any time without notice. Taoglas reserves all rights to this document and the information contained herein. Reproduction, use or disclosure to third parties without express permission is strictly prohibited.



1. Introduction



The Taoglas SXP.18.4.A.02 is part of a series of patch antennas designed for use with Satellite Digital Audio Radio Services (SDARS). It features left-hand circular polarization and excellent gain characteristics in the 2320 to 2345MHz band, making it compatible with the most popular satellite radio services available in many new vehicles.

The SXP.18 comes in a convenient, compact form factor, with dimensions of just 18mm x 18mm x 4mm, and is manufactured with high-quality ceramic. It is mounted via pin and 3M adhesive tape. The SXP series of patched are manufactured in an IATF16949 Approved Facility.

For further optimization to customer-specific device environments, custom tuned patch antennas can be supplied. Your regional Taoglas sales office can help you identify the best patch antenna for your specific SDARS application.

2. Specifications

ELECTRICAL	
Frequency	SIRIUS : 2326.25 MHz \pm 6.25 MHz XM : 2338.75 MHz \pm 6.25 MHz
Centre Frequency	2332.5 MHz \pm 12.5 MHz
Return Loss	SIRIUS: -10 dB max. XM: -10 dB max.
Zenith Gain	SIRIUS: +8 dBiC typ. XM: +9.5 dBiC typ.
Efficiency	SIRIUS: 86 % XM: 87 %
Polarization	LHCP
Impedance	50 Ω
MECHANICAL	
Dimensions	18 x 18 x 4mm
Material	Ceramic
Pin Diameter	0.9mm
Pin Length	2.4mm
Weight	4.9g
ENVIRONMENTAL	
Operation Temperature	-40°C to 85°C
Storage Temperature	-40°C to 105°C
Humidity	Non-condensing 65°C 95% RH

* Antenna properties were measured with the antenna mounted on 70*70mm Ground Plane

XM Gain Requirements (Satellite) – Ground Plane			
AUT Location	Elevation Angle(degrees)	XM Sirius Limits(dBiC)	Measured Average Gain(dBiC)
Passive Ground Plane	20 $\leq\phi\leq$ 25	0.5	2.5
	25 $\leq\phi\leq$ 30	1	3.5
	30 $\leq\phi\leq$ 50	2	4.9
	50 $\leq\phi\leq$ 70	4	7.0
	70 $\leq\phi\leq$ 90	2	8.1

XM Gain Requirements (Terrestrial) – Ground Plane			
AUT Location	Elevation Angle(degrees)	Antenna Mean Passive VP Gain Over Solid Angle (dBi)	Antenna P/P Gain variation (dB)
Passive Ground Plane	0 $^{\circ}\leq\phi\leq$ 10 $^{\circ}$	-2.65dBi	-
	$\Phi=5^{\circ}$	-	2326.25MHz=1.6 dBiC 2338.75MHz=1.2 dBiC

3. Antenna Characteristics

3.1 Return Loss S11

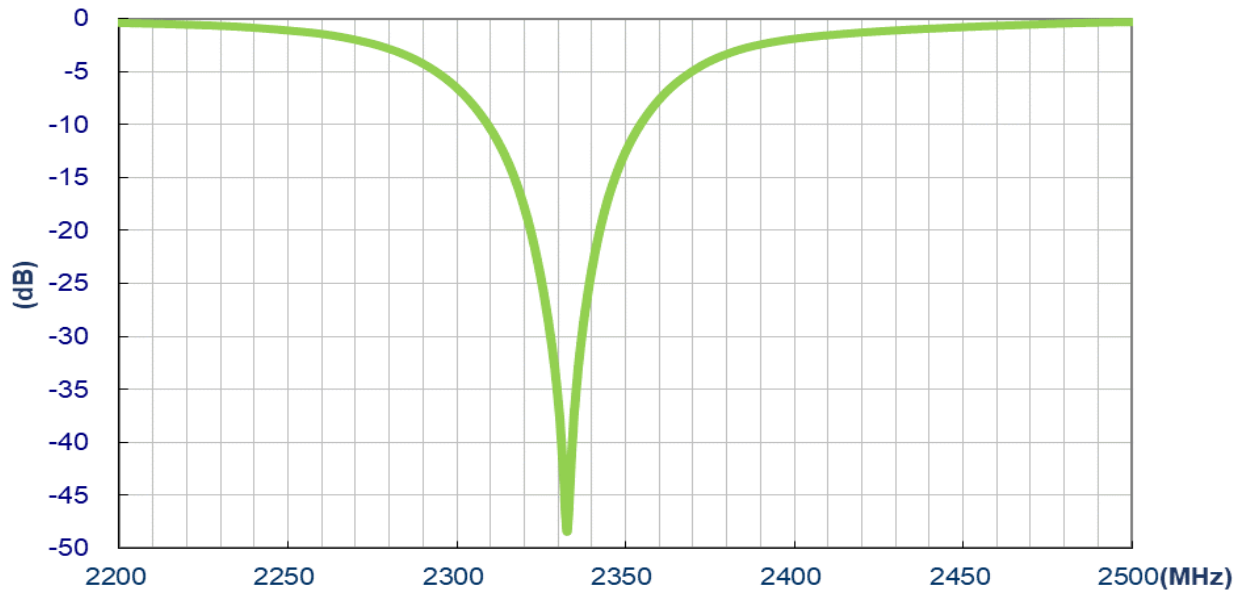

3.2 Efficiency

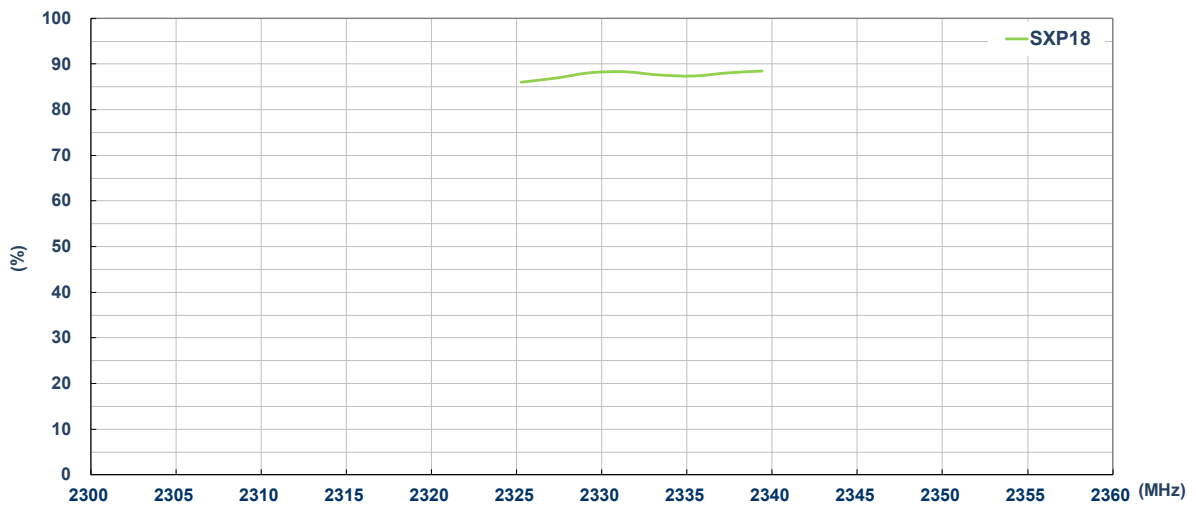

3.3 Peak Gain

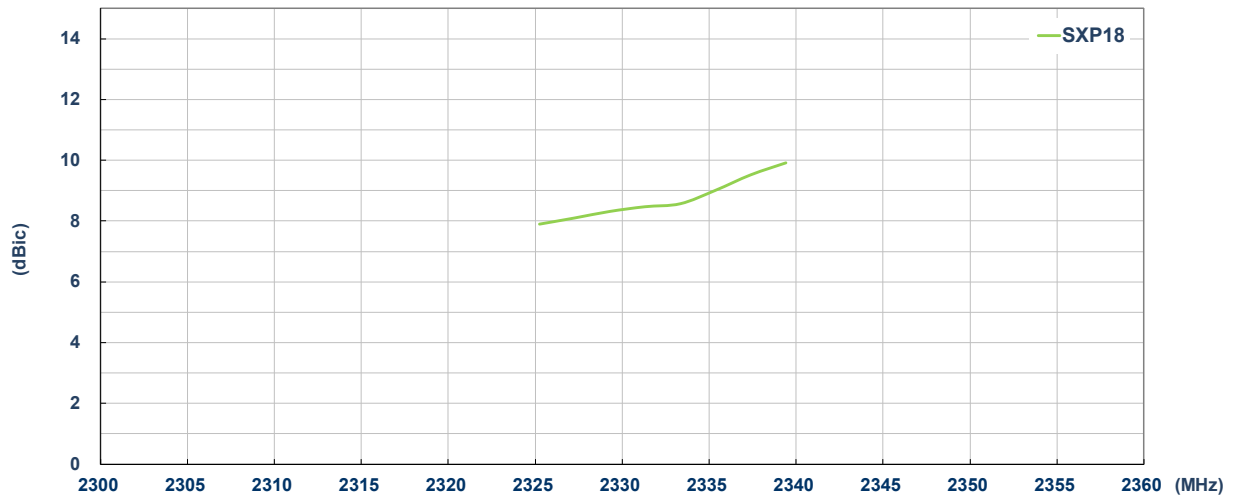

3.4 Average Gain

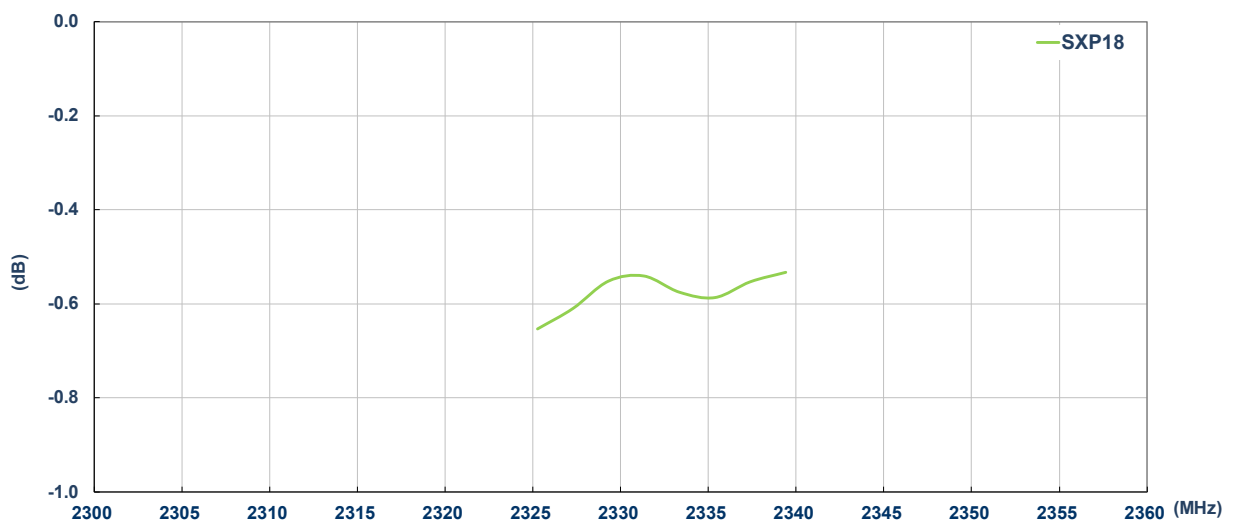

3.5 Axial Ratio @ Phi=0°

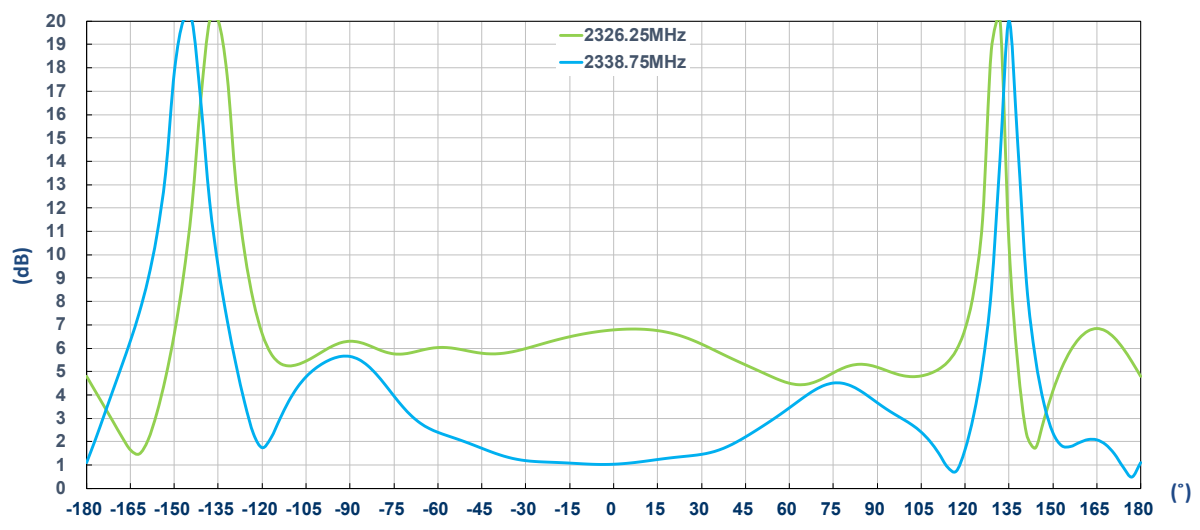

3.6 Axial Ratio @ Phi=90°

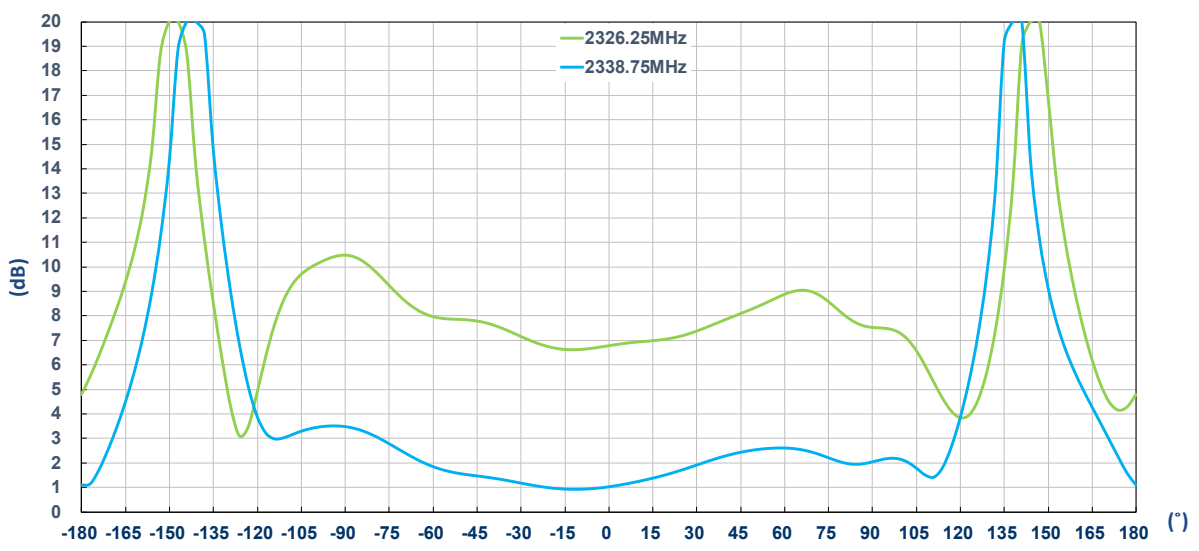

4. 2D Radiation Patterns

4.1 Test Setup

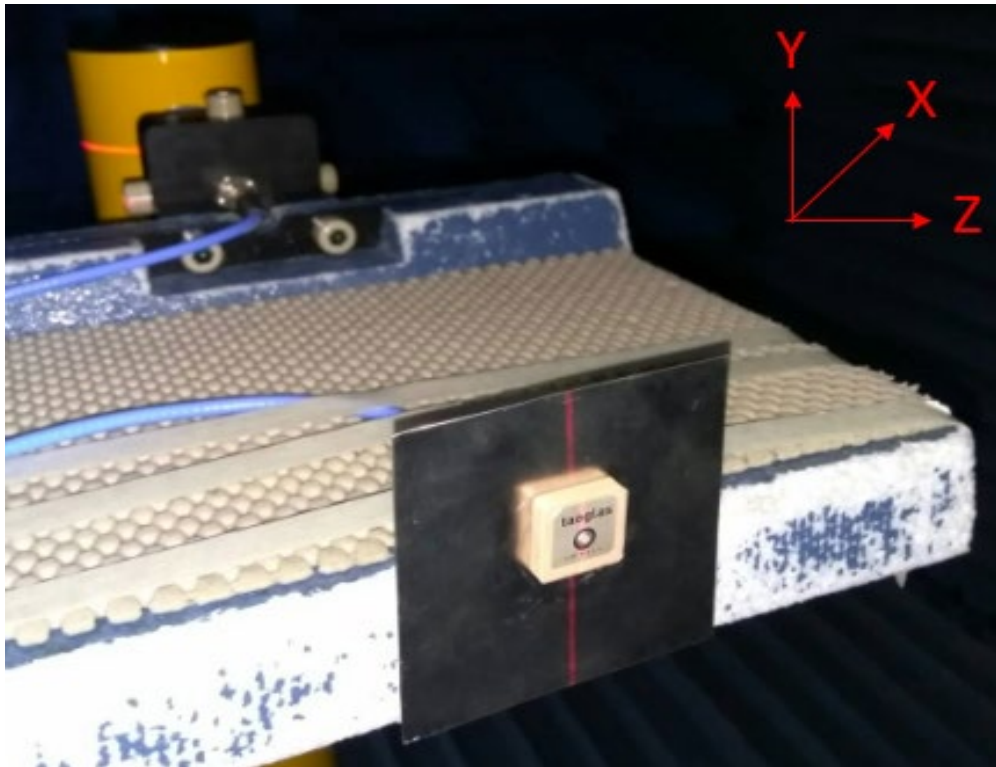

XY Plane

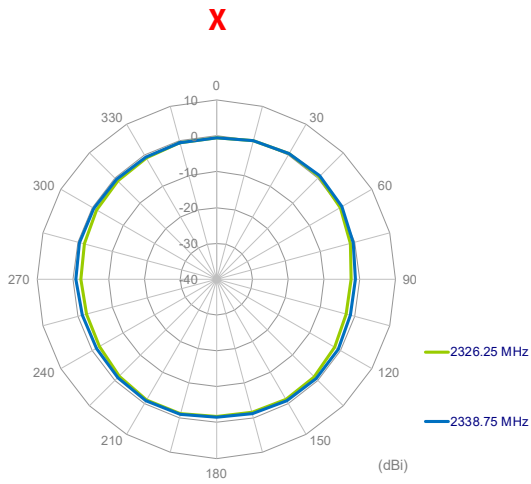

XZ Plane

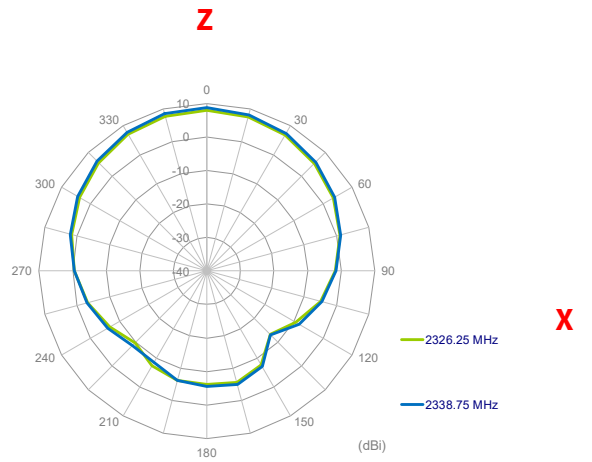

YZ Plane

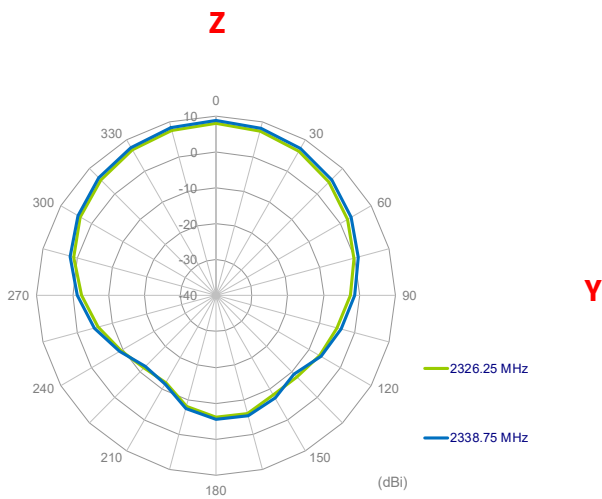

5. 3D Radiation Patterns

5.1 2326.25MHz

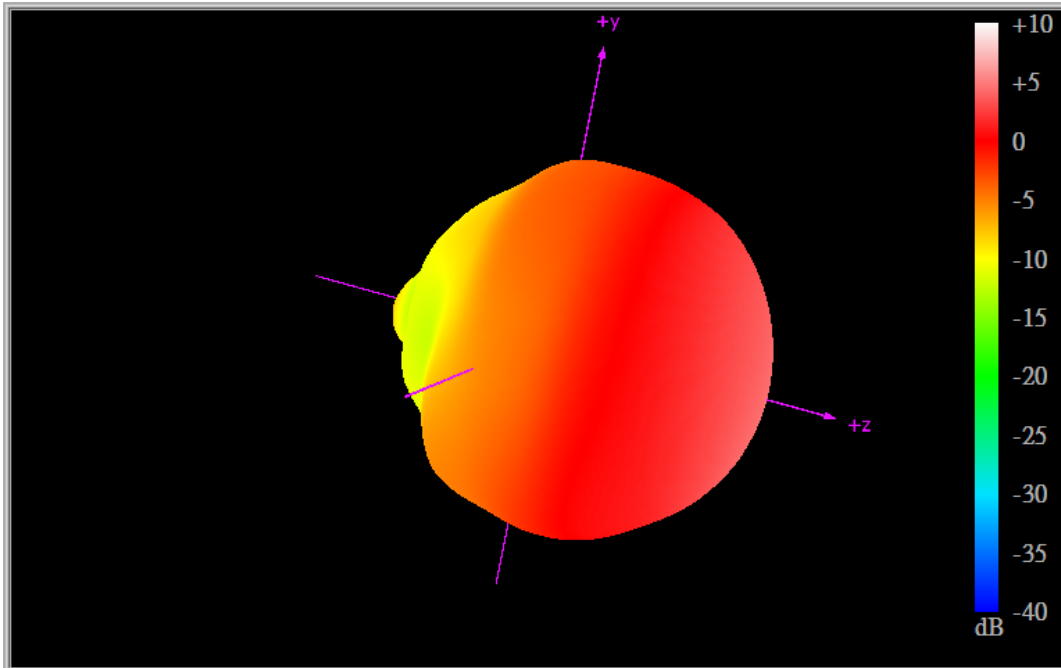

5.2 2338.75MHz

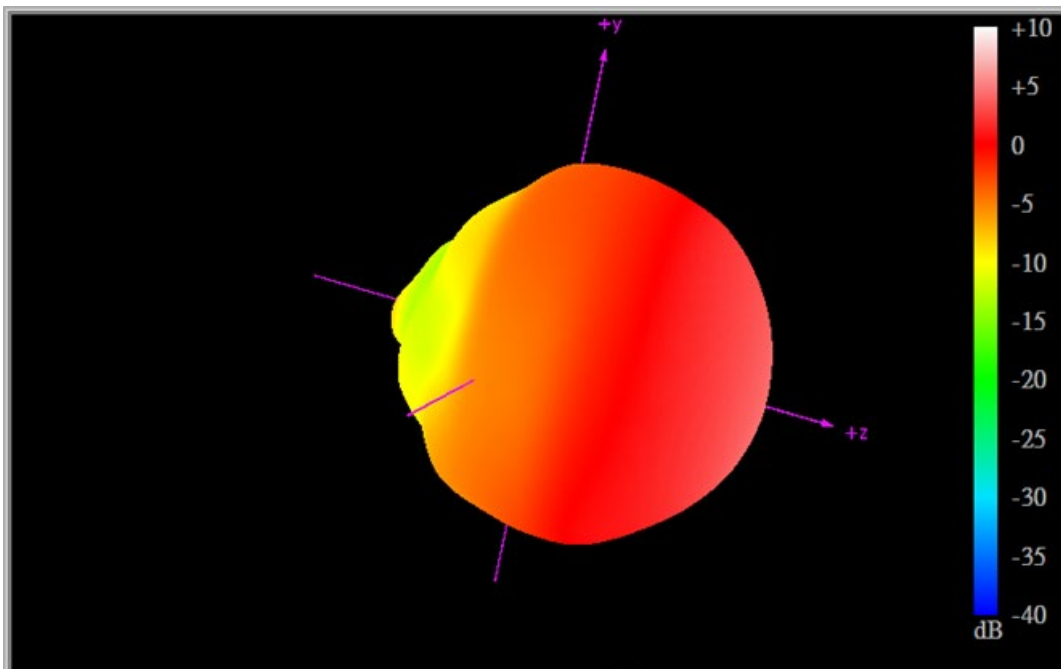

6. Mechanical Drawing-Patch (Units: mm)

ISO NO.: EDW-18-8-6550

STATE: Release

NOTES: 1. Double sided adhesive area.
 2. Soldermask area

REV.	DESCRIPTION	ENG.	APPROVED	DATE
001	Initial Design	Bonnie	Paul	2018/03/07
002	Change Adhesive Design.	Bonnie	Haley	2018/07/03
003	Change the direction of the back	Alster	Haley	2018/10/05
004	Replace the new LOGO <EDR-18-8-259>	Rachel	Joey	2019/01/31
005	EC-21-08-010	Mickey	Buluto	2021/03/02

Front View

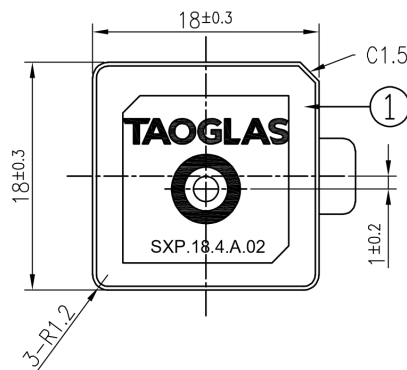

Side View

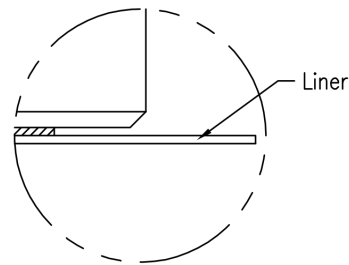
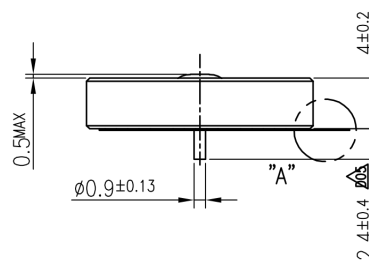

Detail A
Scale:4:1

Back View

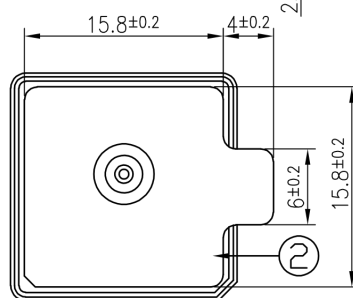

APPROVED BY: Paul	TW Design Centre This drawing and its inherent design concepts are property of Taoglas. Not to be copied or given to third parties without the written consent of Taoglas.					
CHECK BY: Jack						
DRAWN BY: Bonnie						
DATE: 2018/03/07						
UNLESS OTHERWISE SPECIFIED TOLERANCES ON: <table border="0"> <tr><td>XX±0.5</td></tr> <tr><td>X±0.3</td></tr> <tr><td>±0.2</td></tr> <tr><td>XX±0.1</td></tr> <tr><td>XXX±0.05</td></tr> </table>	XX±0.5	X±0.3	±0.2	XX±0.1	XXX±0.05	TITLE : SDARS 2320~2345MHz Dual-Band XM & Sirius Patch Antenna 18*18*4mm
XX±0.5						
X±0.3						
±0.2						
XX±0.1						
XXX±0.05						
THIRD ANGLE PROJECTION	PART NO. : SXP.18.4.A.02					
UNIT: mm	SCALE: 2:1 PAGES: 1/1 REV. D05					

REV.	Name	P/N	Material	Finish	QTY
001	SXP.18 Patch	013A1364002012	Ceramic	Clear	1
002	Double sided Adhesive	013A1364002012	NIITO 5015	White Liner	1

7. PCB Footprint Recommendation

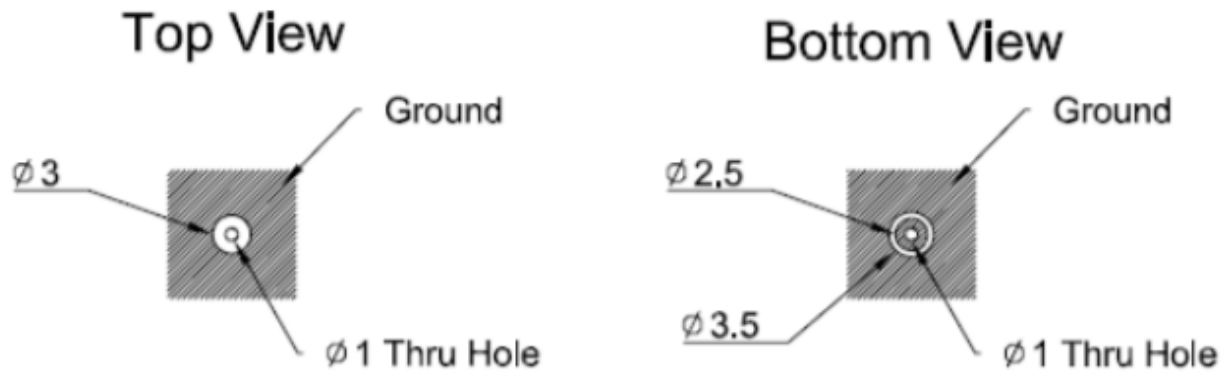

Tolerance: +/- 0,20
Unit:mm

8. Packaging

25pcs SXP.18.4.A.02 per tray
 Tray Dimensions -263*154*mm
 Total Weight – 143g

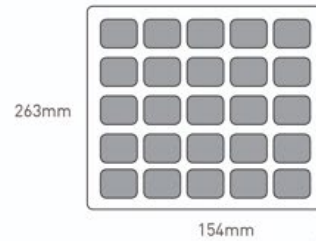

8 trays / 200 pcs SXP.18.4.A.02 per small box
 Small Box Dimensions -263*154*96mm
 Weight – 1.1Kg

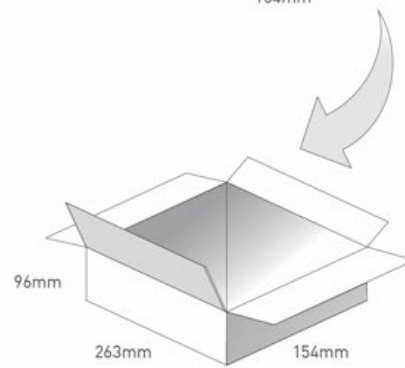

4 small boxes / 800 pcs SXP.18.4.A.02 6 per Carton
 Carton dimensions - 327*280*218mm
 Weight – 4.6Kg

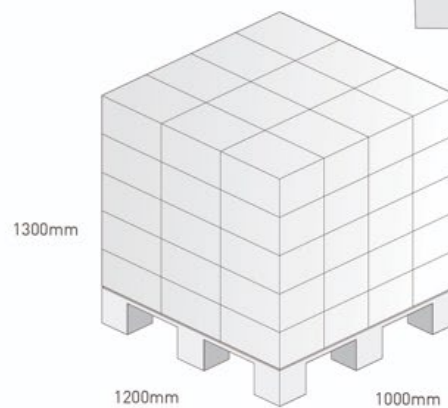
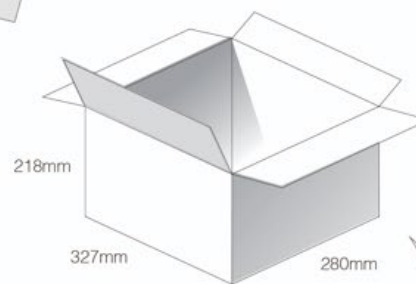

Changelog for the datasheet

SPE-18-8-049 – SXP.18.18.4.A.02

Revision: C (Current Version)

Date:	2024-05-17
Changes:	Updated pin length in spec table
Changes Made by:	Conor McGrath

Previous Revisions

Revision: B (Current Version)

Date:	2022-05-11
Changes:	Template and Product Images Updated
Changes Made by:	Paul Doyle

Revision: A (Original First Release)

Date:	2019-01-20
Notes:	
Author:	Jack Conroy

