



TAOGLAS®



Datasheet

Accura Series

Part No:
TS.125.0111W

Description

Direct SMA(M) Mount Active Multi Band (+ L Band) GNSS Antenna White

Features:

Lightweight and Compact multiband GNSS Antenna
Coverage: L1,L2,L5 and L-Band
IP Rating: IP67 Waterproof Enclosure
Dims: 58mm x 40.5mm
Connector: SMA(M)
RoHS & Reach Compliant

1.	Introduction	3
2.	Specification	4
3.	Mechanical Drawing	7
4.	Installation Guide	8
5.	Packaging	9
6.	Antenna Characteristics	10
7.	LNA Characteristics	16
8.	Field Test Results	19
9.	Radiation Patterns	22
<hr/>		
	Changelog	30

Taoglas makes no warranties based on the accuracy or completeness of the contents of this document and reserves the right to make changes to specifications and product descriptions at any time without notice. Taoglas reserves all rights to this document and the information contained herein. Reproduction, use or disclosure to third parties without express permission is strictly prohibited.



1. Introduction



Multiband GNSS Direct Mount High-Performance Active Antenna

The Taoglas Accura Series, TS.125.0111W is a super small, lightweight, high-performance, active multiband GNSS, direct mount antenna. Covering GPS (L1, L2, L5), Galileo (E1, E5a, E5b) GLONASS (G1, G2, G3) and BeiDou (B1C, B1I, B2a, B2b) frequencies, it is also engineered to cover the L-Band used in modern GNSS correctional services. The active electronics feature SAW filters and LNAs to provide excellent out-of-band interference rejection from unwanted RF signals. The antenna exhibits excellent gain and good radiation pattern stability leading to a reliable GPS fix in areas of weaker signal strength. Manufactured from ABS, the direct mount, IP67-rated enclosure is built to withstand the harshest environments, making it ideal for the most demanding of applications.

Typical applications:

- UAVs and Robotics
- Autonomous Vehicles
- Precision Agriculture
- Telematics and Navigation
- High Accuracy Positioning and RTK Systems

Key features:

- IP67 water resistance: Withstands rain, dust, and even temporary submersion.
- Waterproof O-ring: Keeps water out, even in the most challenging conditions.
- Robust external enclosure: Protects the antenna from shock, vibration, and impact.
- Secure mounting: A unique indented SMA(M) connector ensures a solid, reliable connection.
- Super lightweight design at only 33.8g.

Whether you're tracking vehicles, autonomous robotics or UAV's, navigating remote areas, or connecting your enterprise assets, the TS.125 delivers reliable GPS performance you can count on. Contact your local Taoglas customer support team to learn more about how this versatile antenna can meet your specific needs.

2. Specification

GNSS Frequency Bands					
GPS	L1 1575.42 MHz	L2 1227.6 MHz	L5 1176.45 MHz		
	■	■	■		
GLONASS	G1 1602 MHz	G2 1248 MHz	G3 1207 MHz		
	■	■	■		
Galileo	E1 1575.24 MHz	E5a 1176.45 MHz	E5b 1201.5 MHz	E6 1278.75 MHz	
	■	■	■	□	
BeiDou	B1C 1575.42 MHz	B1I 1561 MHz	B2a 1176.45 MHz	B2b 1207.14 MHz	B3 1268.52 MHz
	■	■	■	■	□
L-Band	L-Band 1542 MHz				
	■				
QZSS (Regional)	L1 1575.42 MHz	L2C 1227.6 MHz	L5 1176.45 MHz	L6 1278.75e6	
	■	■	■	□	
IRNSS (Regional)	L5 1176.45 MHz				
	■				
SBAS	L1/E1/B1 1575.42 MHz	L5/B2a/E5a 1176.45 MHz	G1 1602 MHz	G2 1248 MHz	G3 1207 MHz
	■	■	■	■	■

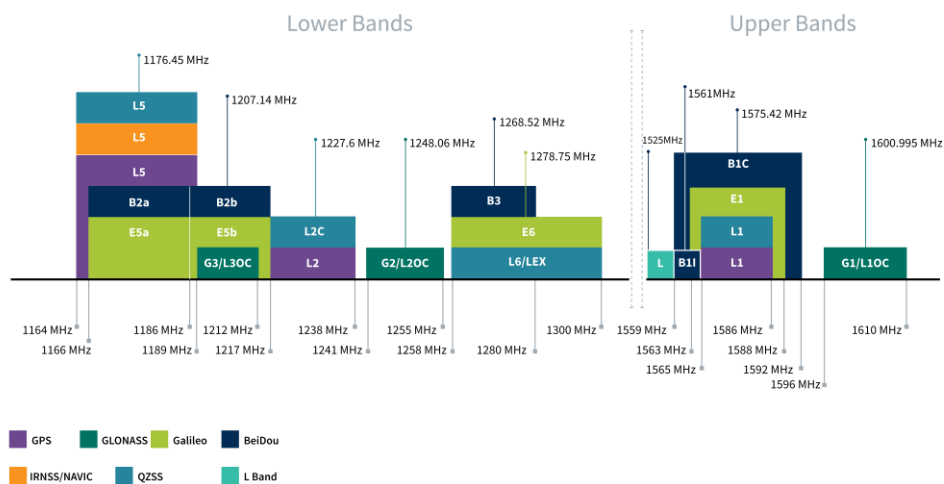

GNSS Bands and Constellations

GNSS Electrical								
Frequency (MHz)	1176.45	1201.55	1227.6	1248	1542	1561	1575.42	1603
VSWR (max.)	1:1	1:1	1:1	1:1	1:1	1:1	1:1	1:1
Passive Antenna Efficiency (%) (Without cable loss)	32.63	33.32	32.22	31.06	52.53	53.83	51.64	44.9
Passive Antenna Gain at Zenith (dBic) (Without cable loss)	-0.35	-0.24	-0.32	-0.39	0.75	0.86	0.86	0.45
Axial Ratio (dB)	0.26	0.16	0.08	0.05	0.58	0.51	0.72	0.77
PCO (cm)	0.09	0.12	0.14	0.14	0.23	0.25	0.33	0.32
PCV (cm)	0.21	0.16	0.14	0.11	0.14	0.31	0.28	0.25
Polarization	RHCP							
Impedance	50 Ω							
Connector	SMA(M)							
Antenna Reference Position (ARP): Center of the antenna horizontally, bottom plane								

LNA and Filter Electrical Properties								
Frequency (MHz)	1176.45	1201.55	1227.6	1248	1542	1561	1575.42	1603
Gain@3.0V (dBic)	32.1	32.3	32.7	31.3	26.9	26.8	26.1	25.9
Noise@3.0V (dBic)	2.4	1.7	2.3	2.2	3.1	2.9	2.3	3.3
Group Delay(ns)	18.8	14.8	17.8	21.6	17.1	15.7	15.8	21.9
Voltage Range	+2.0 - +5.5V							
Current Draw	7 - 13mA							

Mechanical	
Dimensions	Ø40.5 x 58.5mm
Weight	33.8g
Material	ABS
Connector	SMA(M)

Environmental	
Temperature Range	-40°C - +85°C
Waterproof	IPX7 (when mounted)
Vibration	ISO 16750, 10 – 1000Hz, 3 axes, 8 hours/axis
Mechanical Shock	ISO 16750-3 4.2.2
ESD	IEC 61000-4-2 8kV contact/15kV air discharge

3. Mechanical Drawing

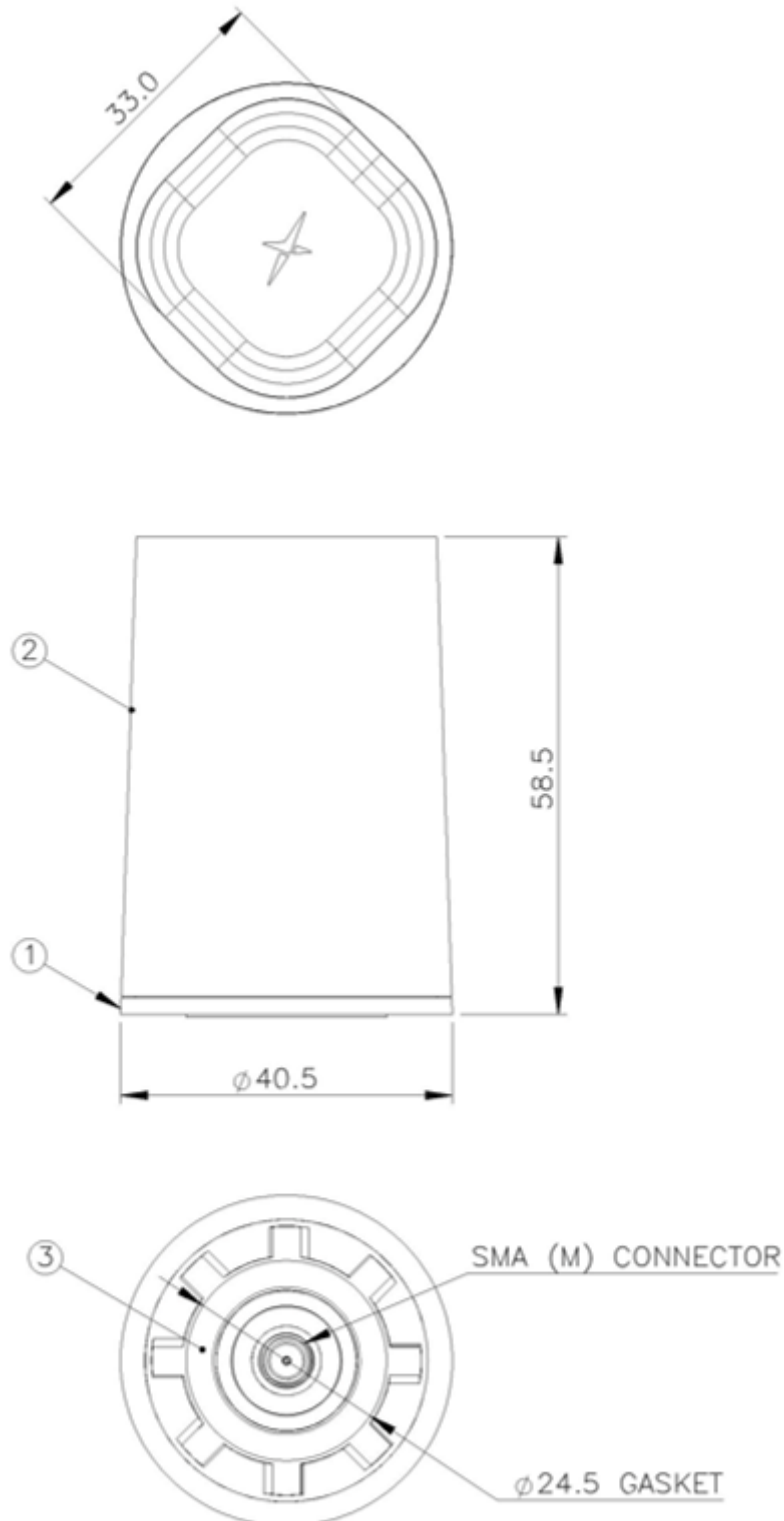

ITEM NO.	DESCRIPTION	MATERIAL	QTY.
1	BOTTOM HOUSING AND OVERMOLED CONNECTOR TS.125	ABS	1
2	Top Housing TS.125	ABS	1
3	RUBBER GASKET	Neoprene	1

4. Installation Guide

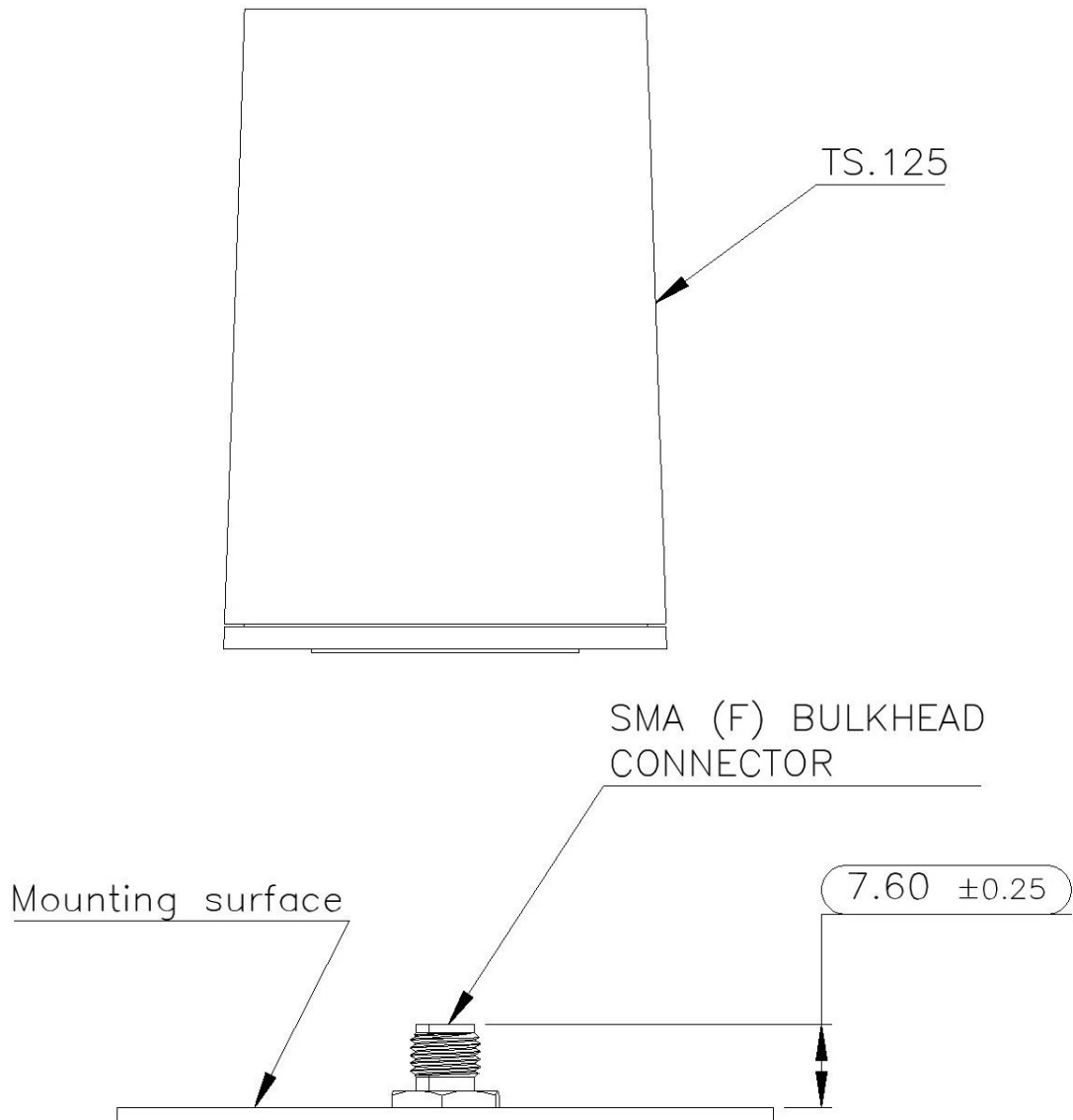

NOTE: HAND TIGHTEN ONLY.
 A CONNECTOR PROTRUSION HEIGHT
 OF 7.60 ± 0.25 mm IS REQUIRED TO
 ENSURE A WATER TIGHT IPX7 RATING.

5. Packaging

1pc TS.125.0111 per PE Bag
 Bag dimensions – 120x170mm
 Weight – 33.8g



10pcs TS.125.0111 per PE Bag
 Bag dimensions 220x460mm
 Weight – 0.35Kg



360pcs TS.125.0111 per carton
 Dimensions 370x370x300mm
 Weight – 4.3Kg



6. Antenna Characteristics

6.1 Return Loss

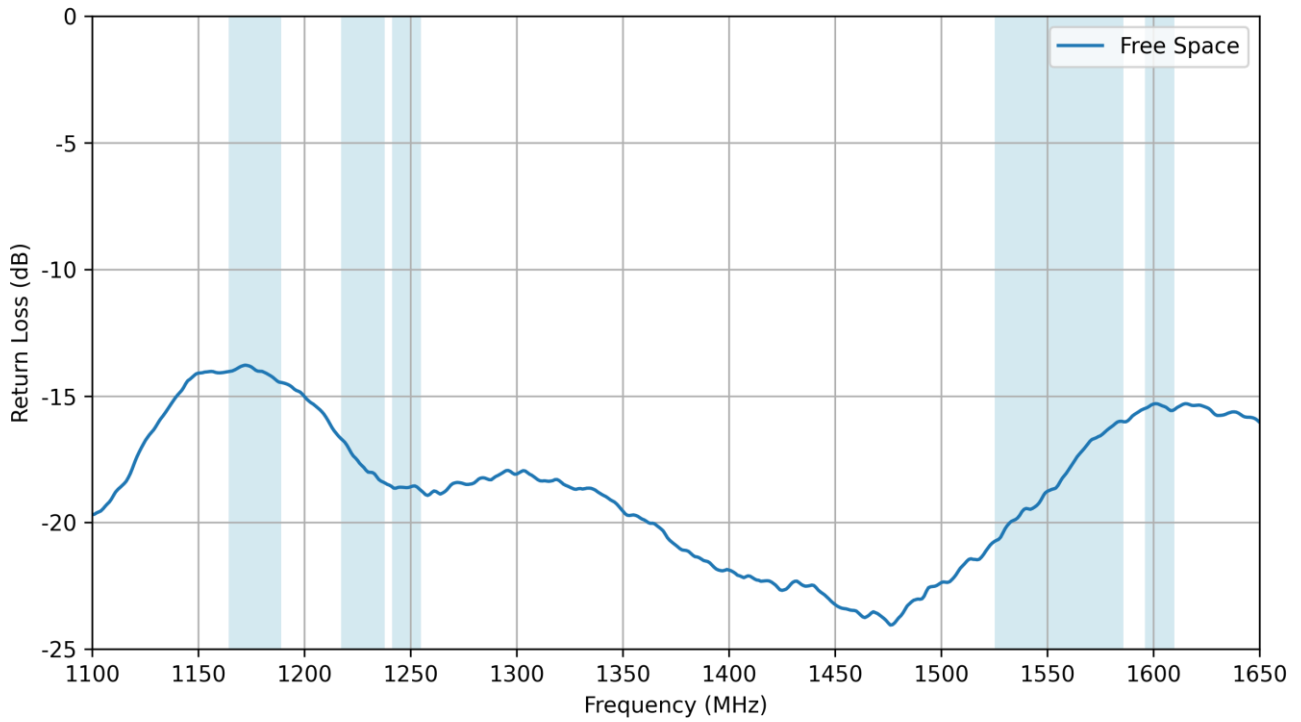

6.2 VSWR

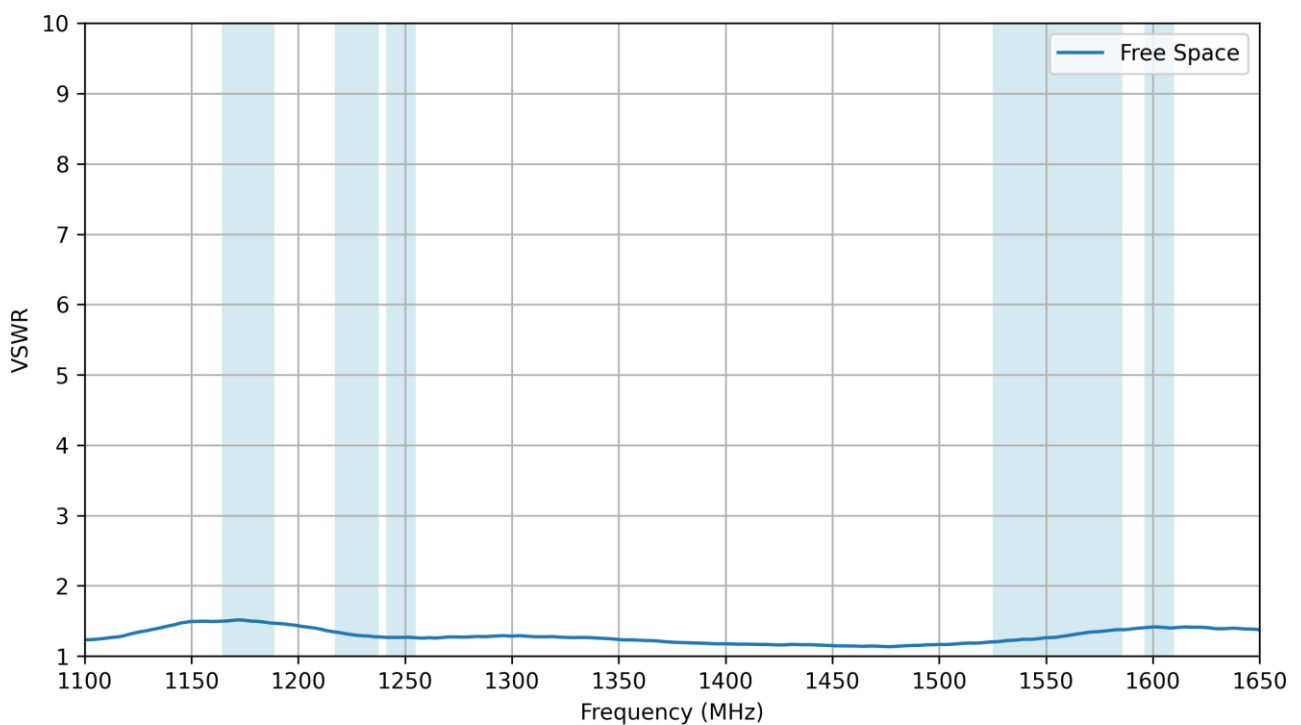

6.3 Efficiency

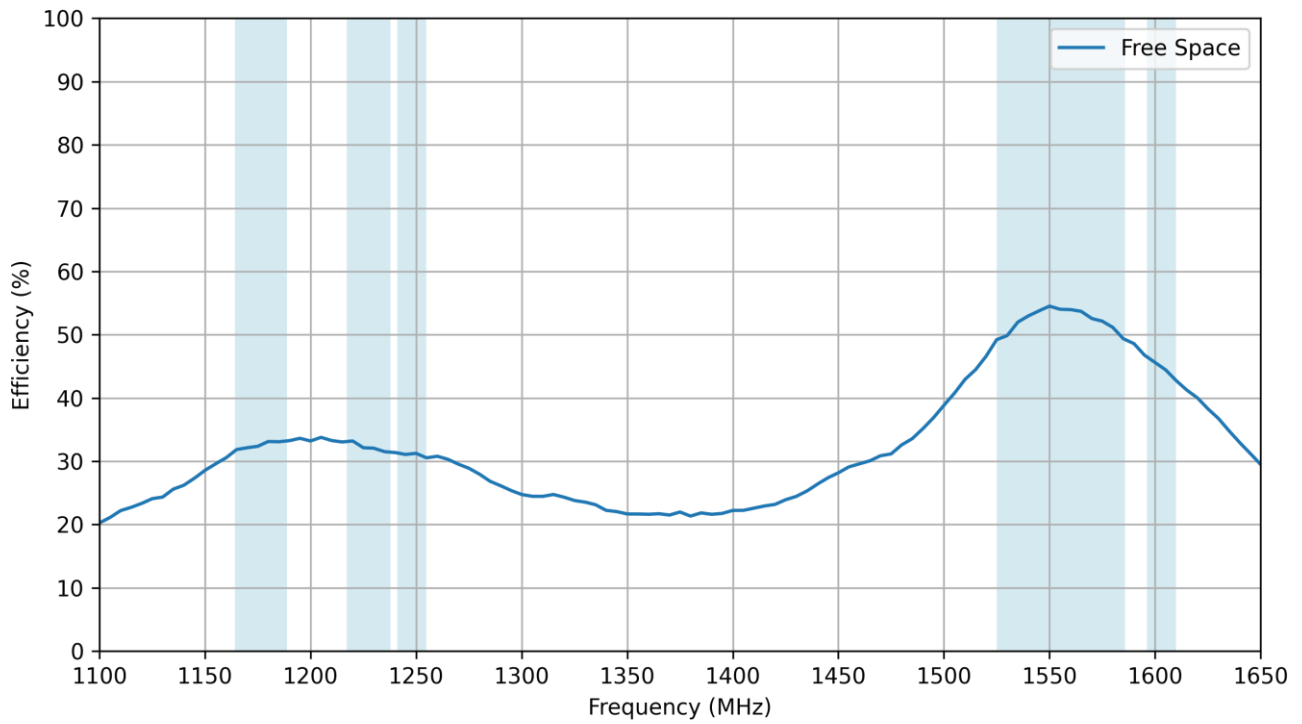

6.4 Average Gain

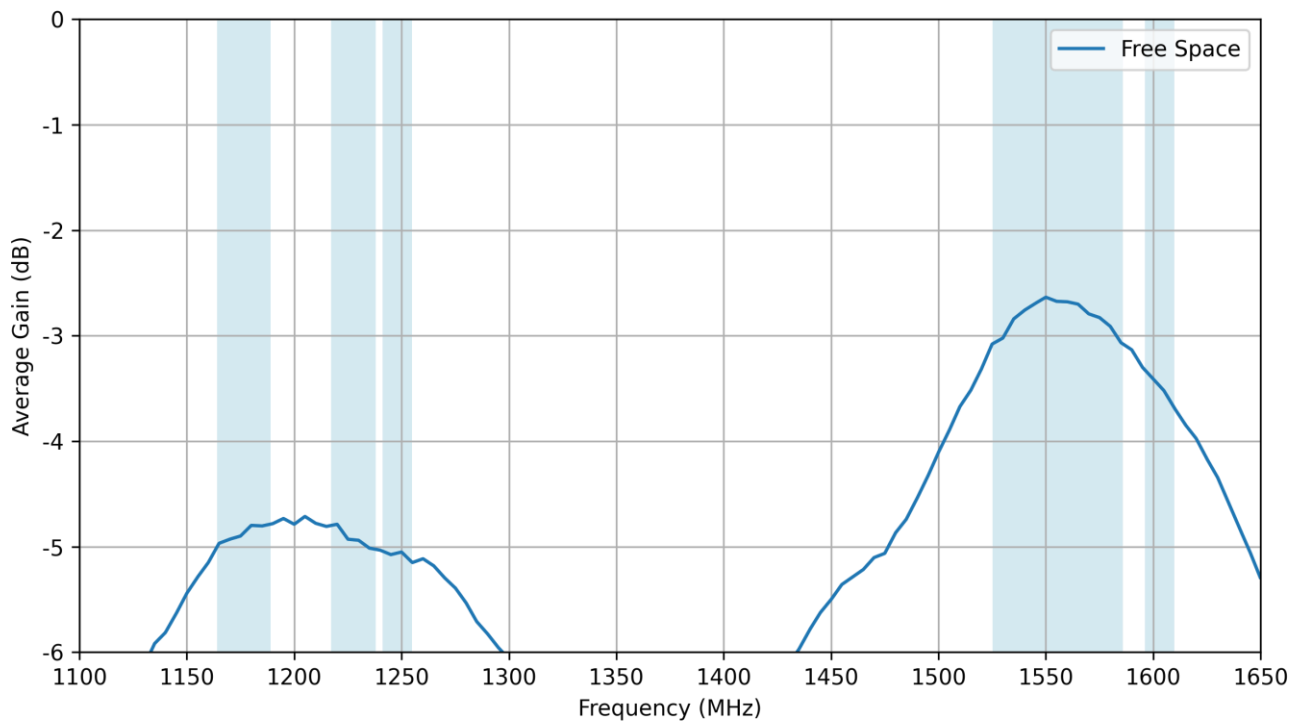

6.5 Peak Gain

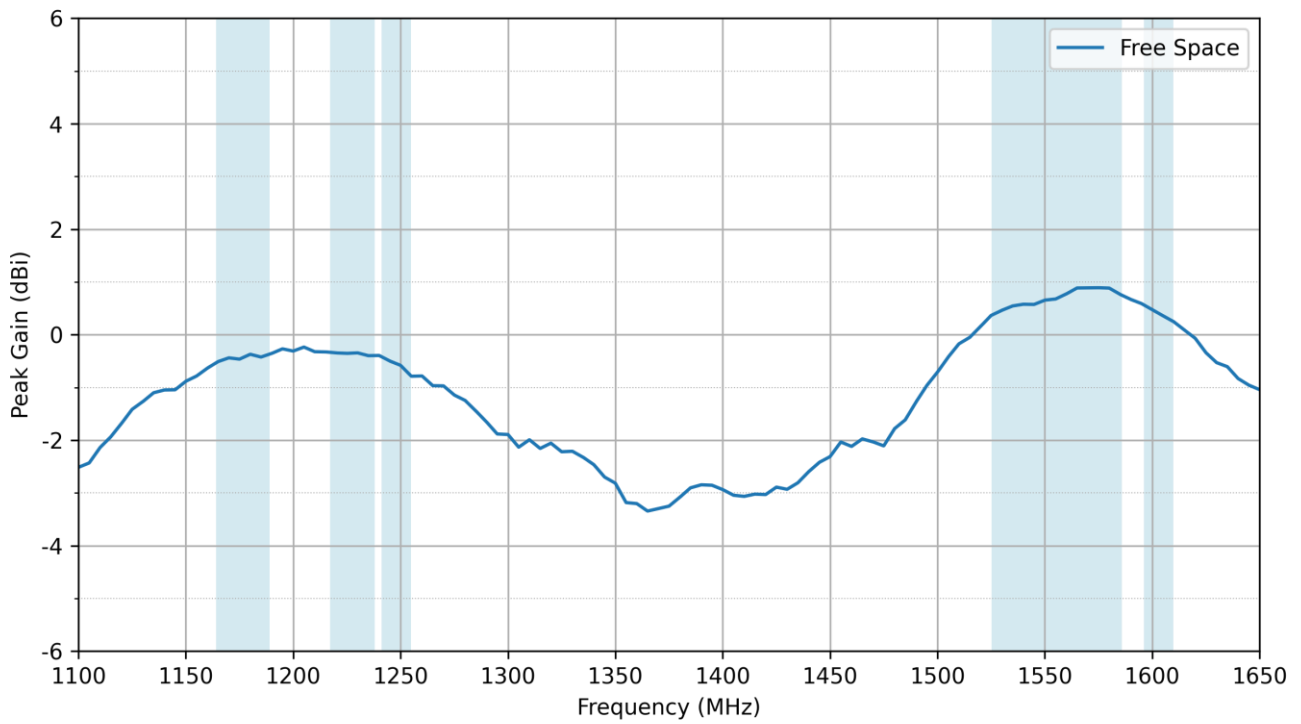

6.6 Axial Ratio

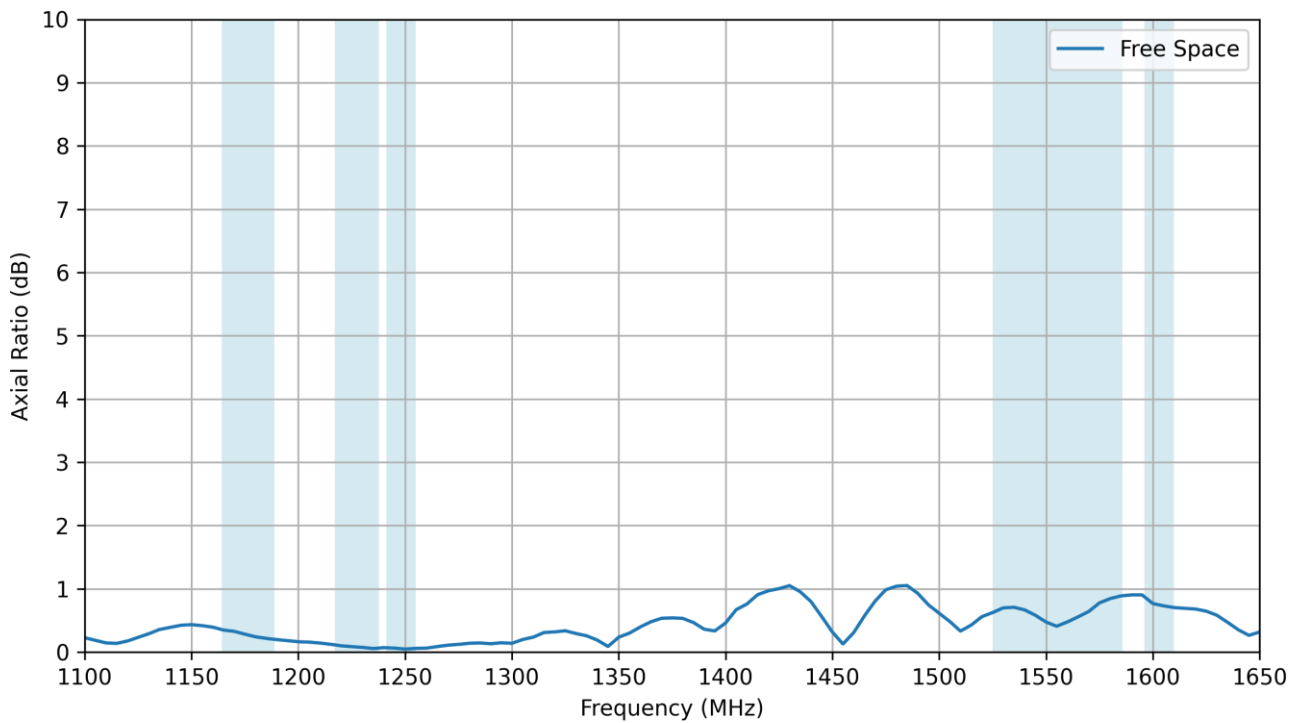

6.7 AR vs Angle for Phi=0

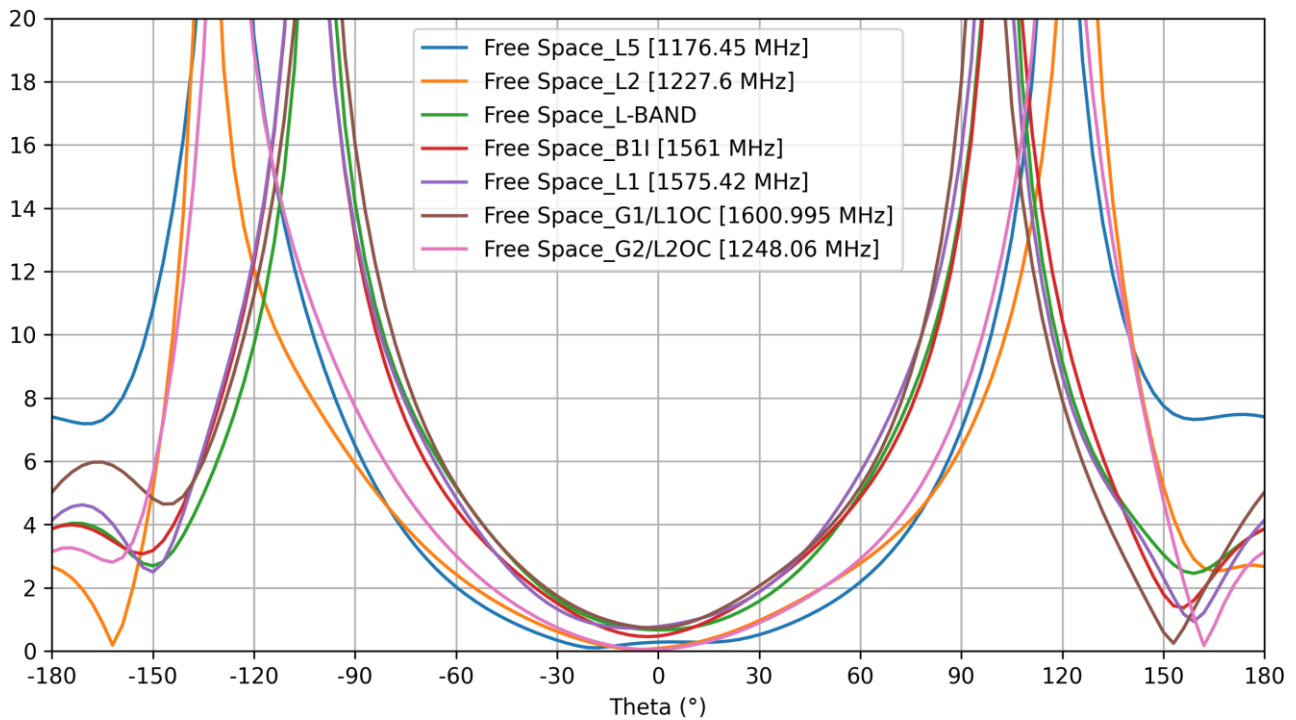

6.8 AR vs Angle for Phi=90

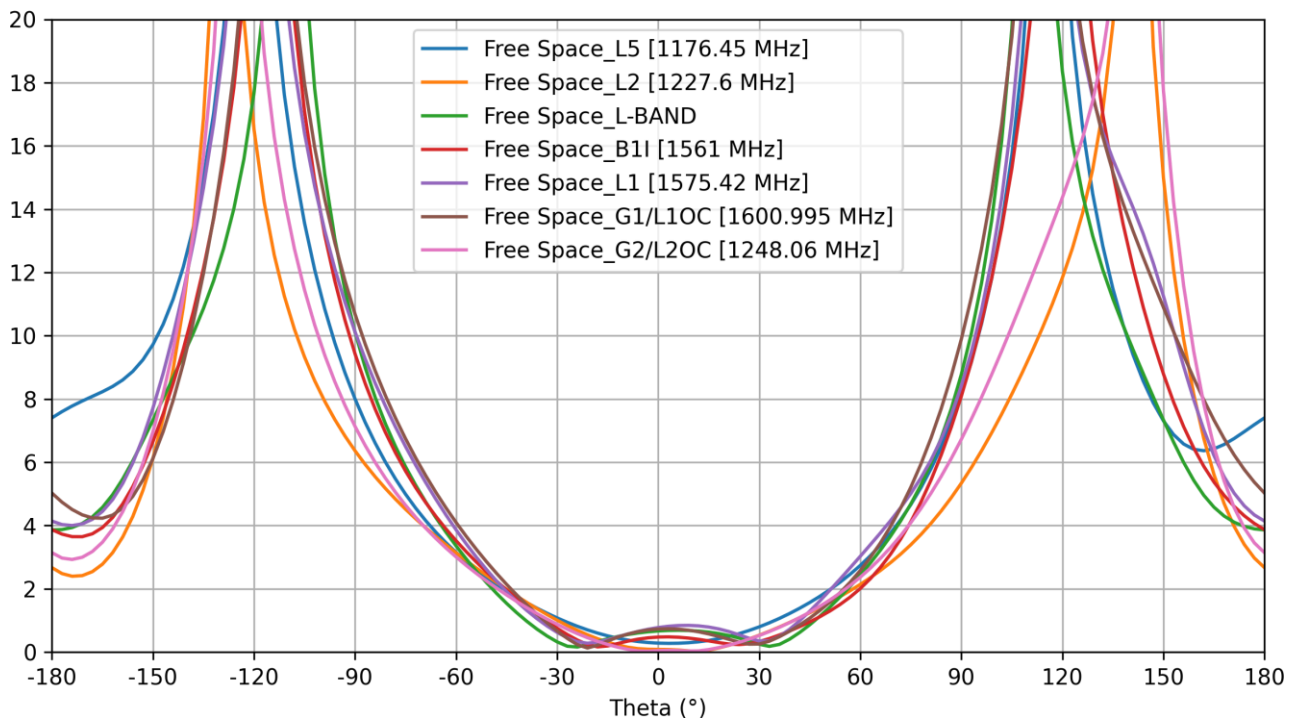

6.9 AR vs Angle for Theta=90

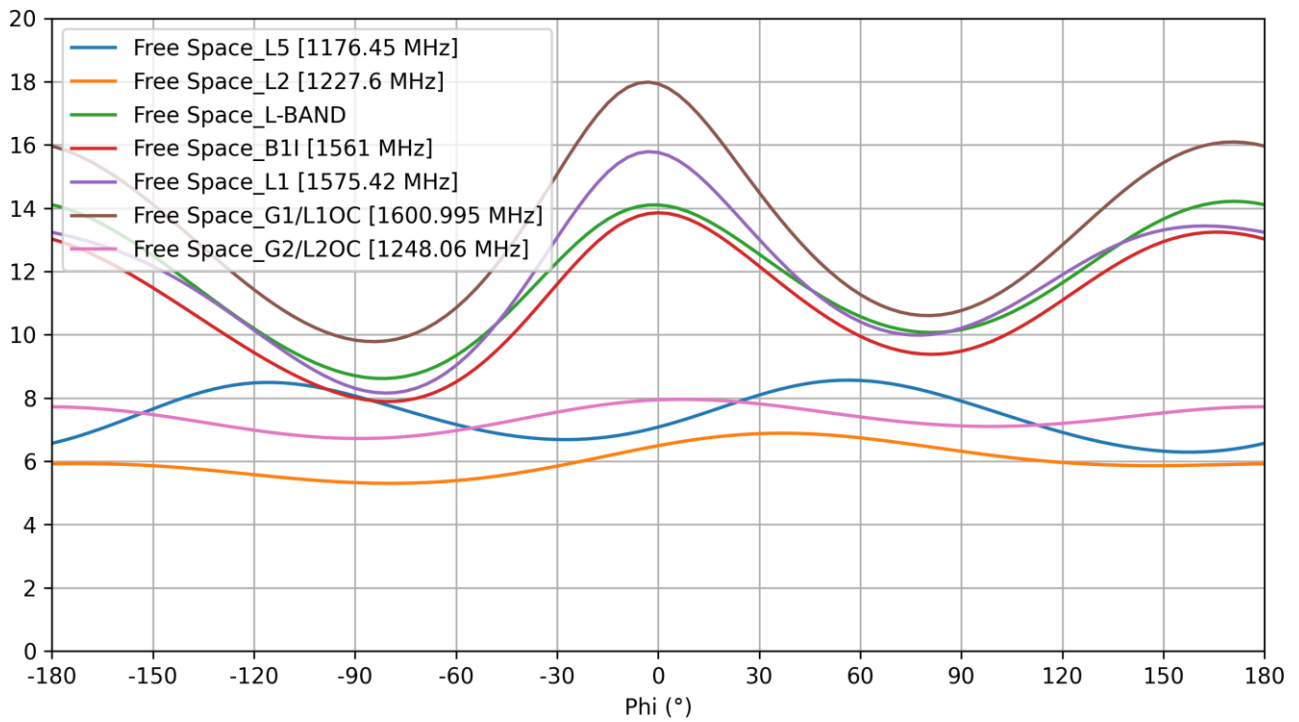

6.10 PCO

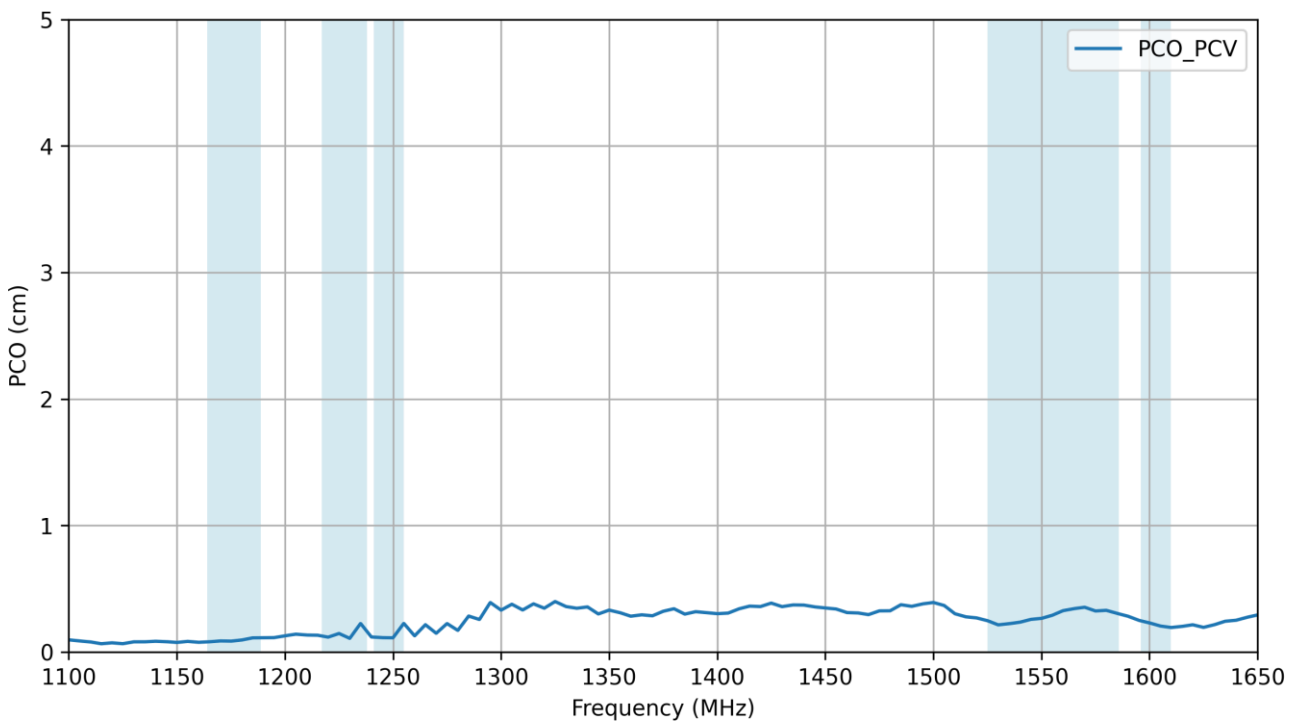

6.11 PCV

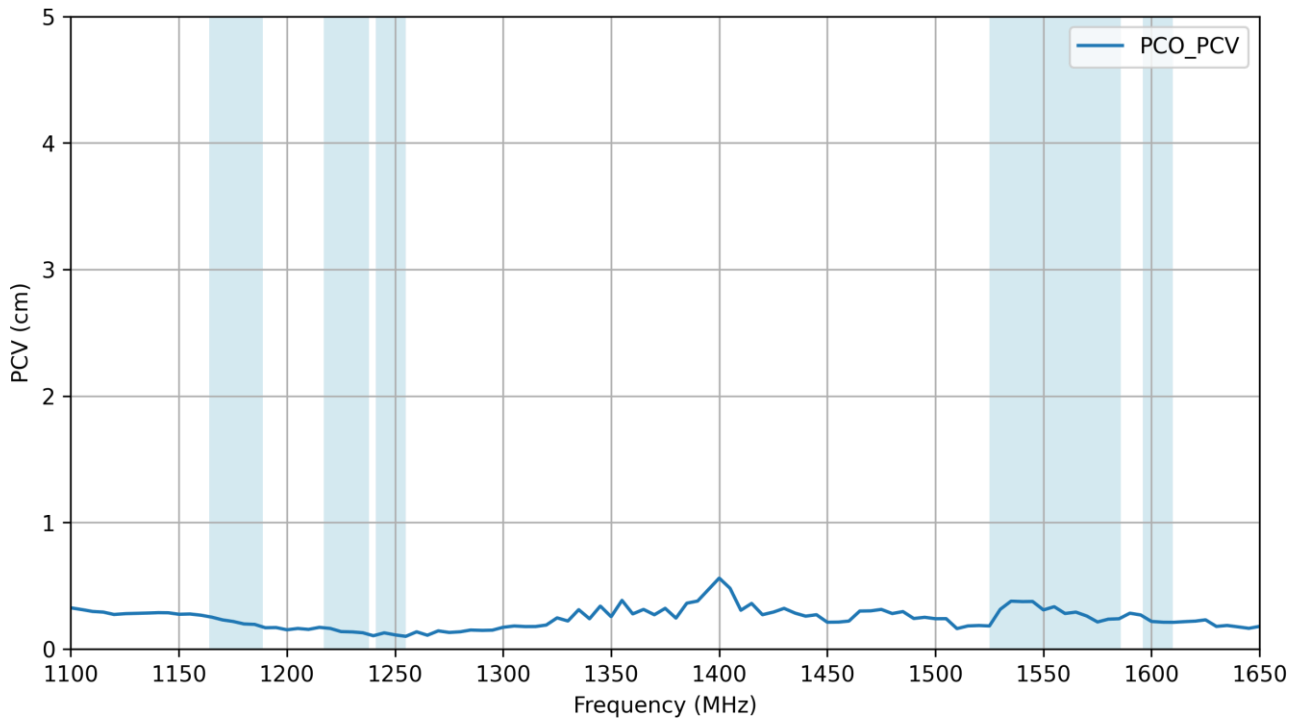

7. LNA Characteristics

7.1 Gain – Low-Band

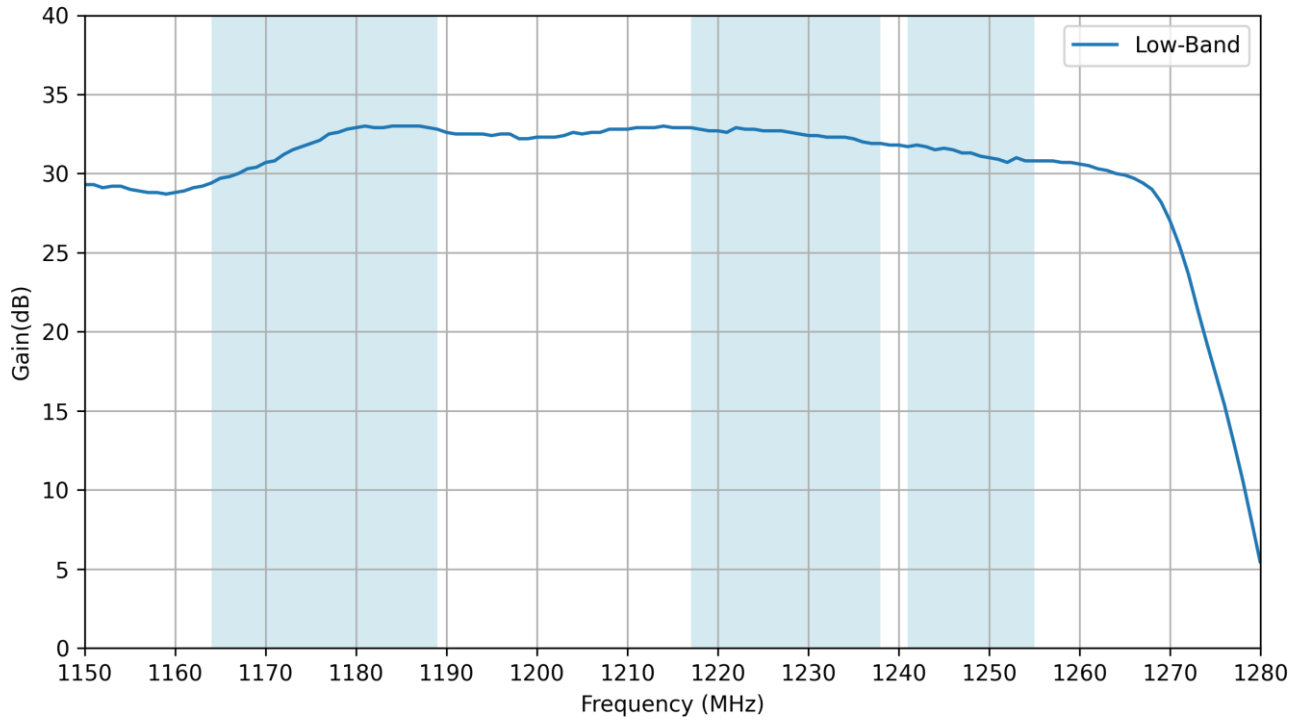

7.2 Gain – High-Band

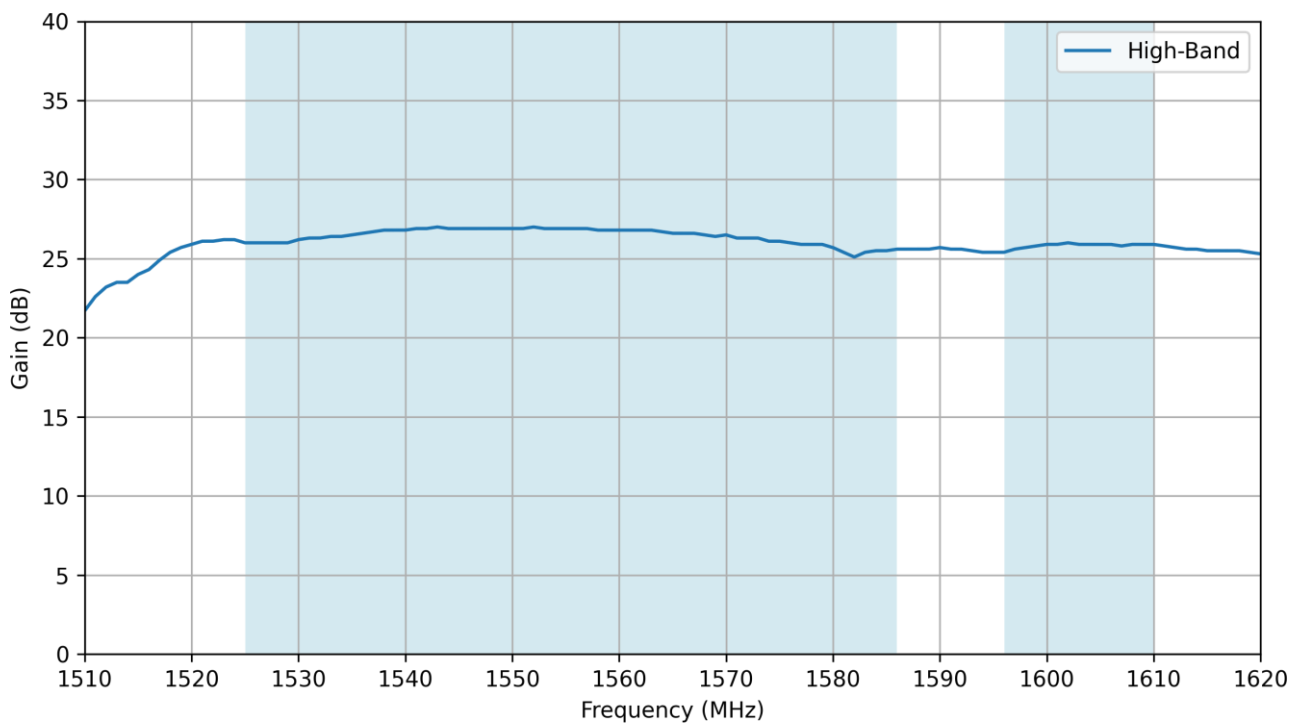

7.3 Noise Figure – Low-Band

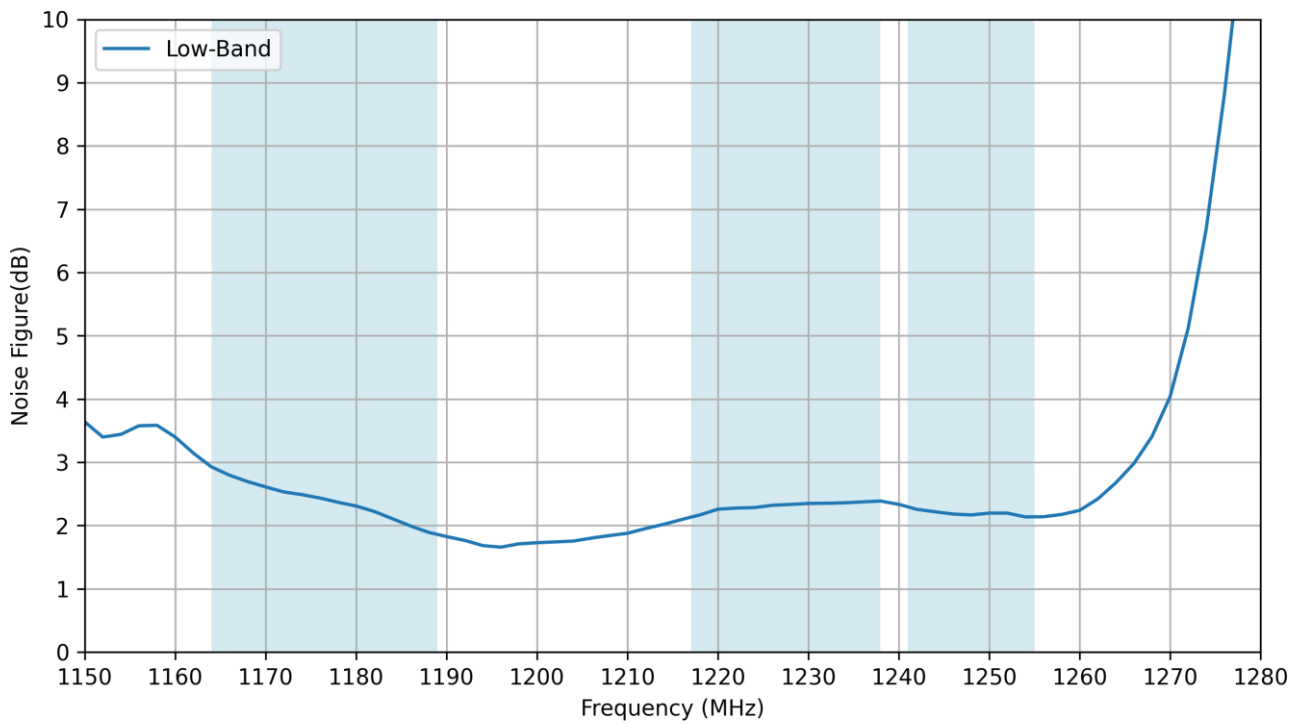

7.4 Noise Figure – High-Band

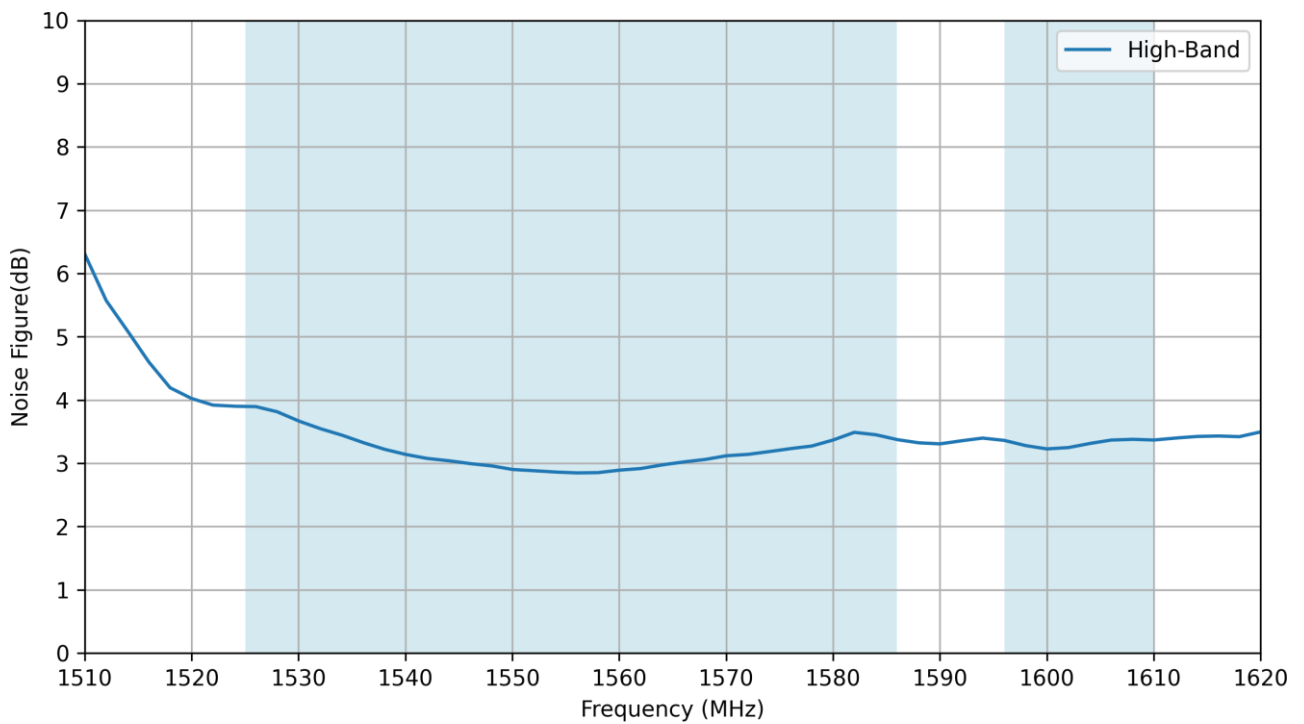

7.5 Out Of Band Attenuation

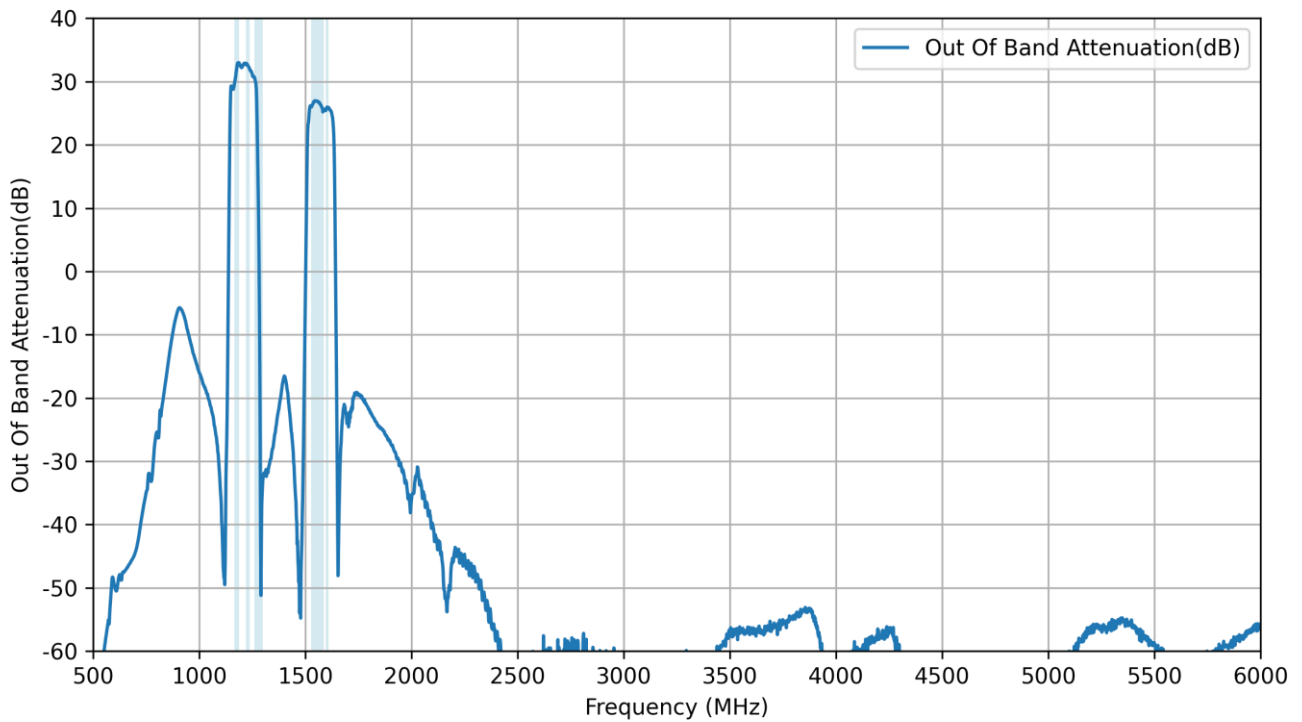

7.6 Group Delay

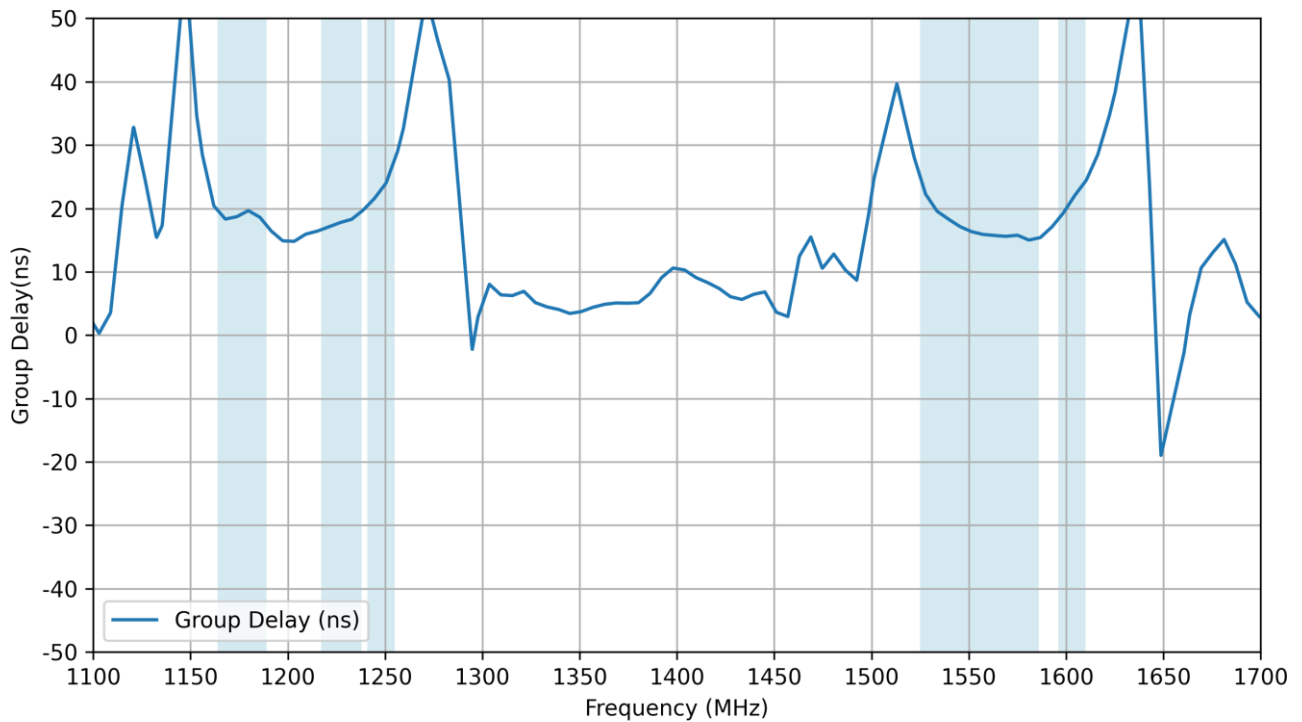

8. Field Test Results

In this section Taoglas will present the field test result for TS.125.0111 antenna. The test was performed when the antenna was mounted on a static rooftop test set up in an open sky environment for at least 7 hours.

Taoglas will show the field test results using the following receivers:

8.1 U-blox ZED-F9P

Receiver features:

- Multi-band GNSS: 184-channel GPS L1C/A L2C, GLONASS: L1OF L2OF, Galileo: E1B/C E5b, BeiDou: B1I B2I, QZSS: L1C/A L2C L1S , SBAS L1C/A
- Multi-band RTK with fast convergence times and reliable performance
- Nav. update rate RTK up to 20 Hz
- Position accuracy = RTK 0.01 m + 1 ppm CEP

Positioning Accuracy Table (2D Accuracy)					
Test Condition	Correction Service	CEP (50%)	DRMS (68%)	2DRMS (95%)	TTF (sec)
Free Space	PPP-RTK DISABLED	35.78 cm	43.65 cm	89.3 cm	24
	PPP-RTK ENABLED	15.95 cm	19.13 cm	38.26 cm	31

No Correction Signal Quality

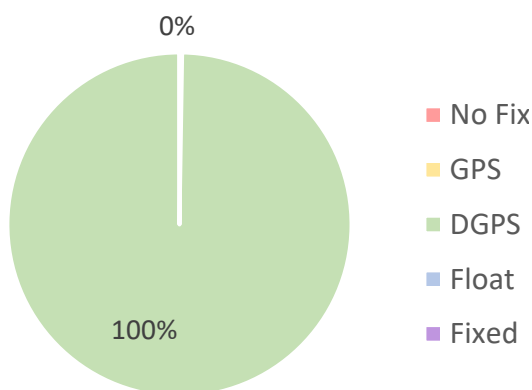

Point Perfect Signal Quality

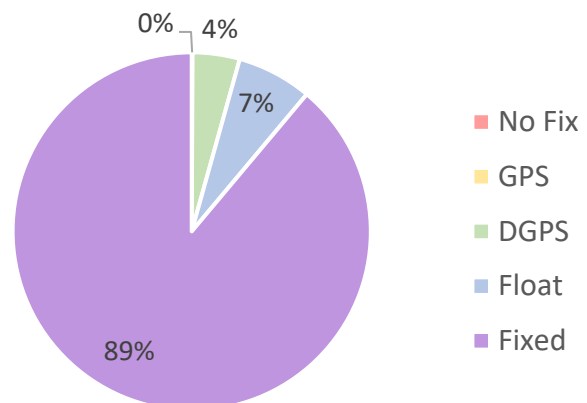

8.2 U-blox NEO-F9P

Receiver features:

- Multi-band GNSS: 184-channel GPS L1C/A L5, GLONASS L1OF, GALILEO E1B/C E5a, BeiDou B1I B2a, QZSS L1C/A L1S L5, SBAS L1C/A
- Nav. update rate: RTK up to 20 Hz
- Position accuracy = 0.01 m + 1 ppm CEP

Positioning Accuracy Table (2D Accuracy)					
Test Condition	Correction Service	CEP (50%)	DRMS (68%)	2DRMS (95%)	TTF (sec)
Free Space	PPP-RTK DISABLED	32.02 cm	38.71 cm	77.41 cm	25
	PPP-RTK ENABLED	8.04 cm	9.62	19.24 cm	33

No Correction Signal Quality

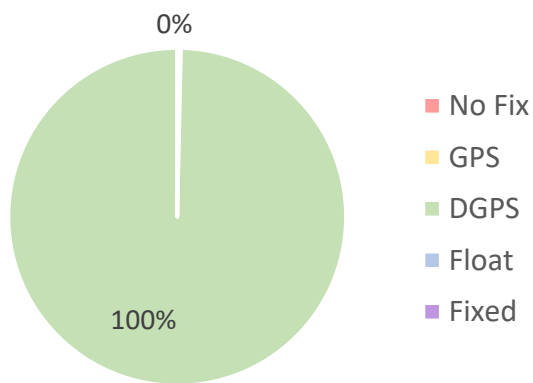

Point Perfect Signal Quality

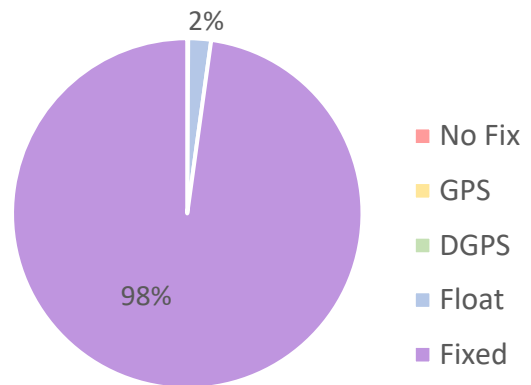

8.3 Septentrio - AsteRx-U

Receiver features:

- Multi-band GNSS: 544 channels
- GPS: L1, L2, L5 GLONASS: L1, L2, L3 Galileo: E1, E5ab, AltBoc, E6 BeiDou: B1, B2, B3 NavIC: L51 QZSS: L1, L2, L5, L6
- SBAS: EGNOS, WAAS, GAGAN, MSAS, SDCM(L1, L5)
- RTK (base and rover), Integrated dual-channel L-band receiver, Support for PPP
- Nav. update rate up to 100 Hz
- Position accuracy = RTK 0.6 cm + 0.5 ppm

Positioning Accuracy Table (2D Accuracy)					
Test Condition	Correction Service	CEP (50%)	DRMS (68%)	2DRMS (95%)	TTF (sec)
Free Space	PPP-RTK DISABLED	33.98 cm	40.87 cm	81.73 cm	43
	PPP-RTK ENABLED	6.77 cm	8.11 cm	16.23 cm	45

No Correction Signal Quality

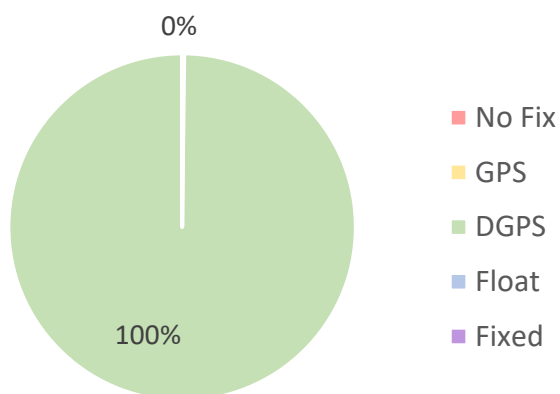

SwiftNav Correction Signal Quality

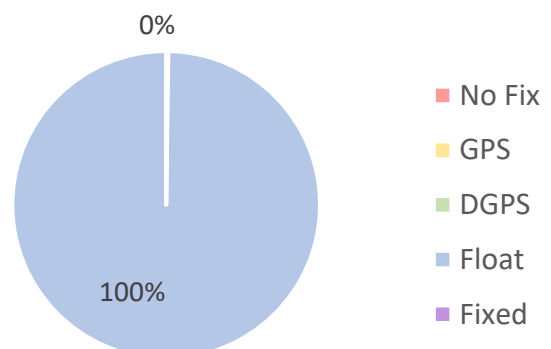

9. Radiation Patterns

9.1 Test Setup

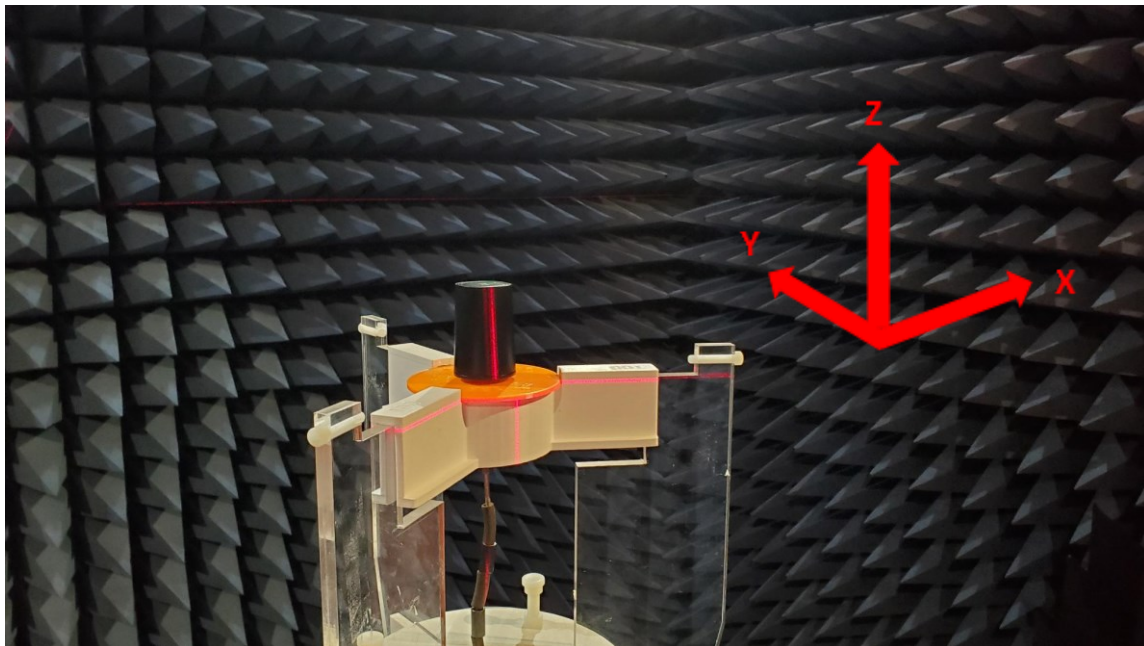
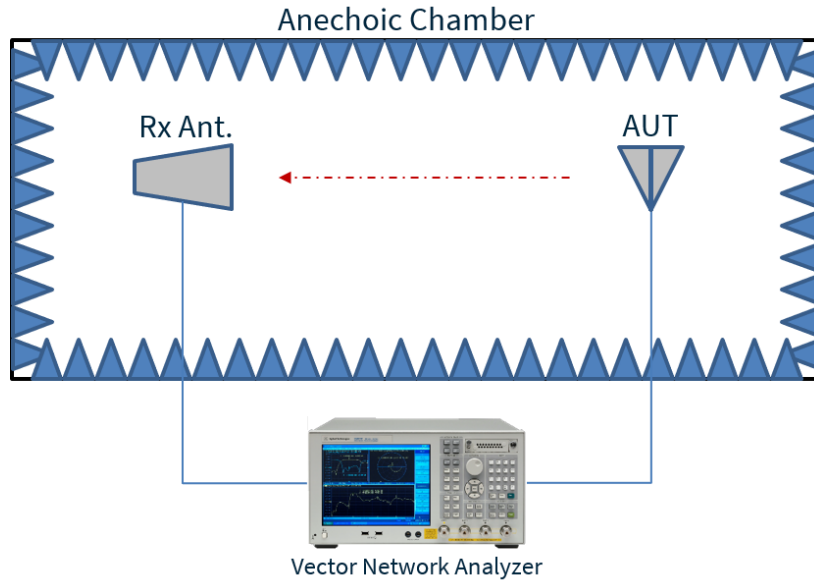

TS.125 – Chamber Set-up

9.2 Free Space Patterns at 1175 MHz

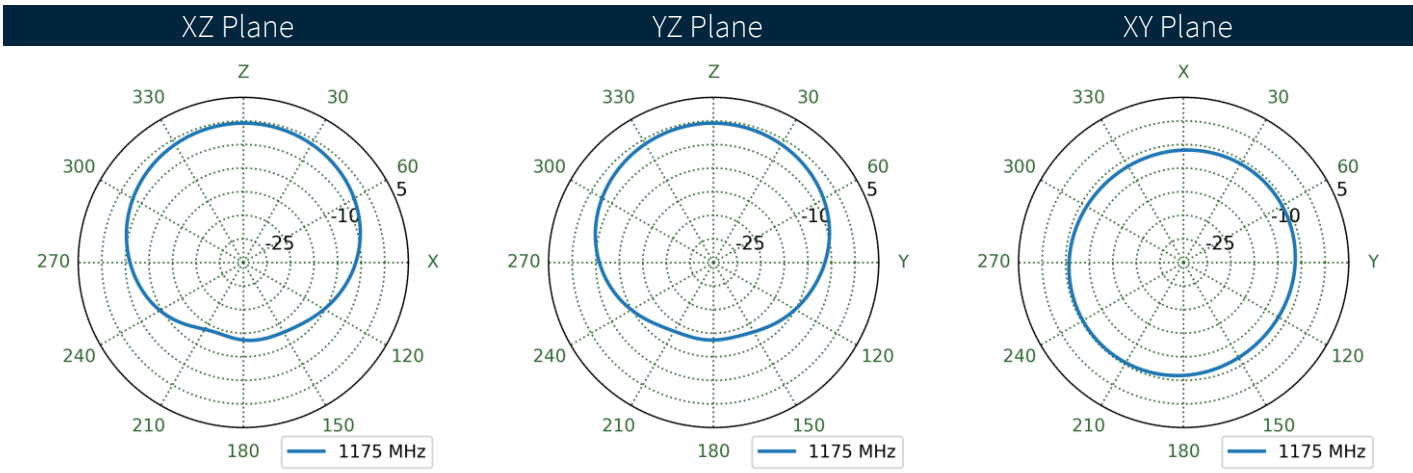
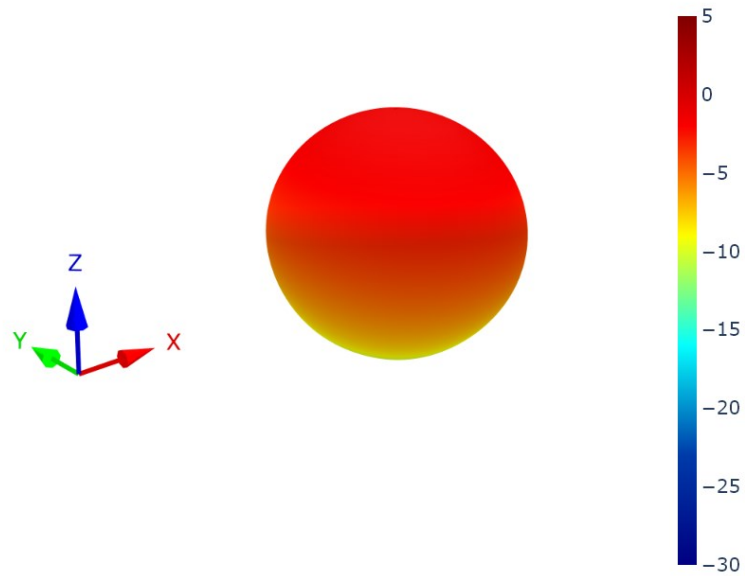

9.3 Free Space Patterns at 1225 MHz

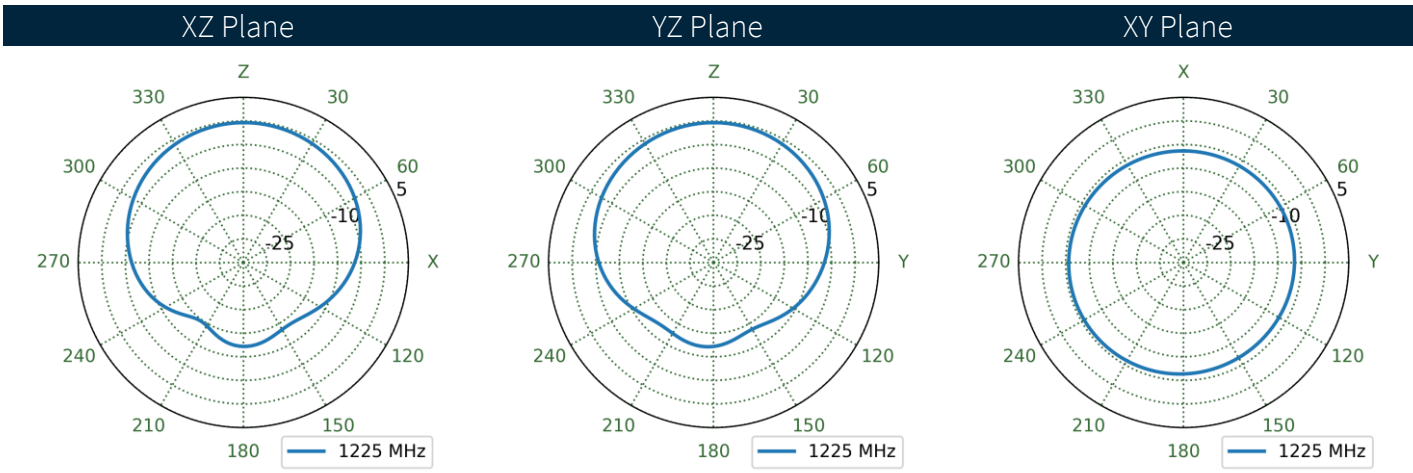
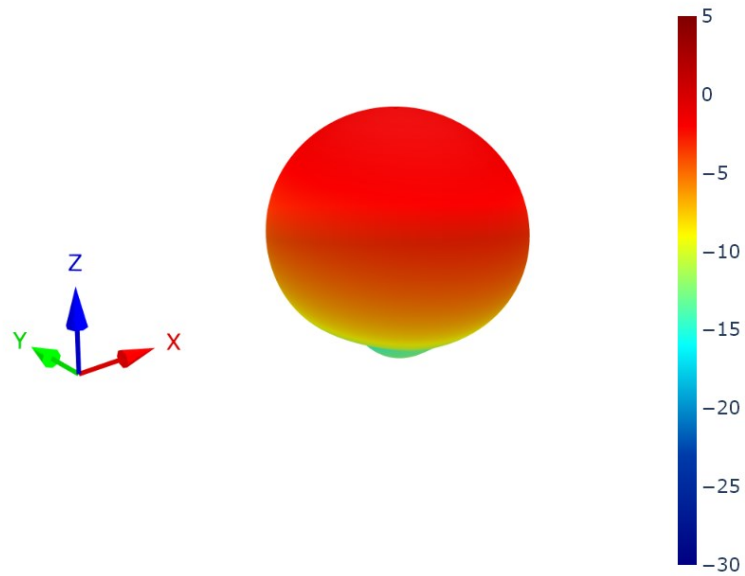

9.4 Free Space Patterns at 1250 MHz

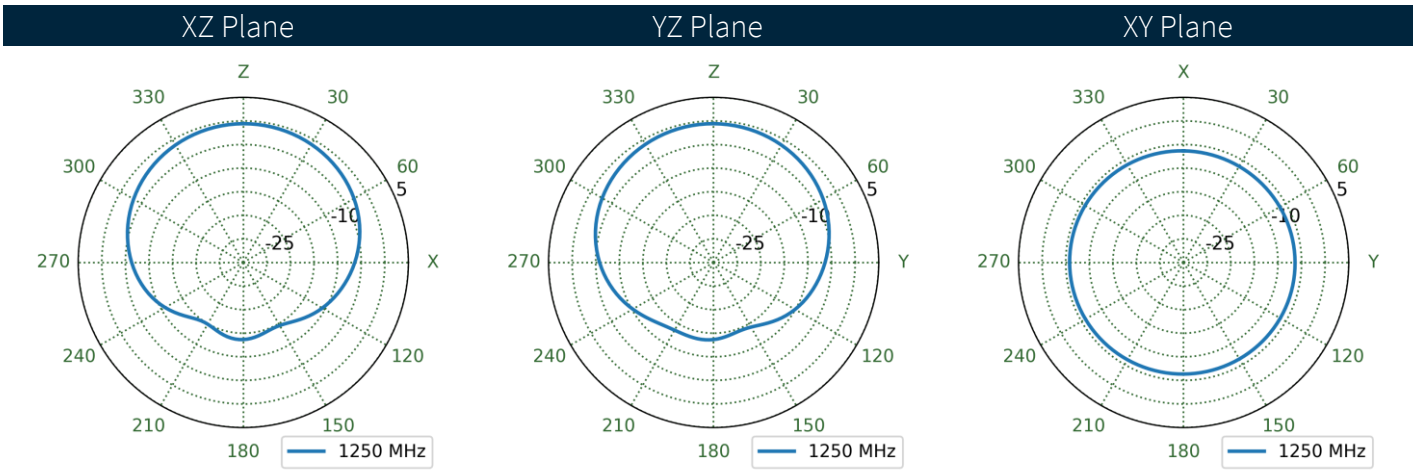
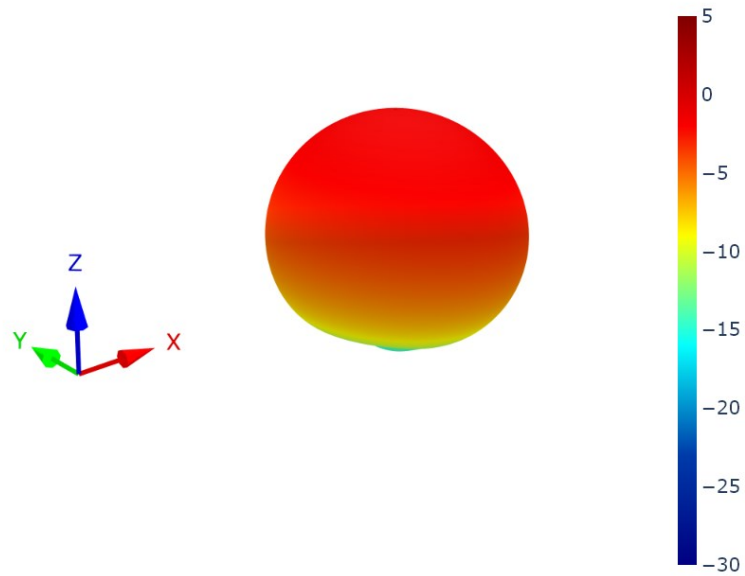

9.5 Free Space Patterns at 1540 MHz

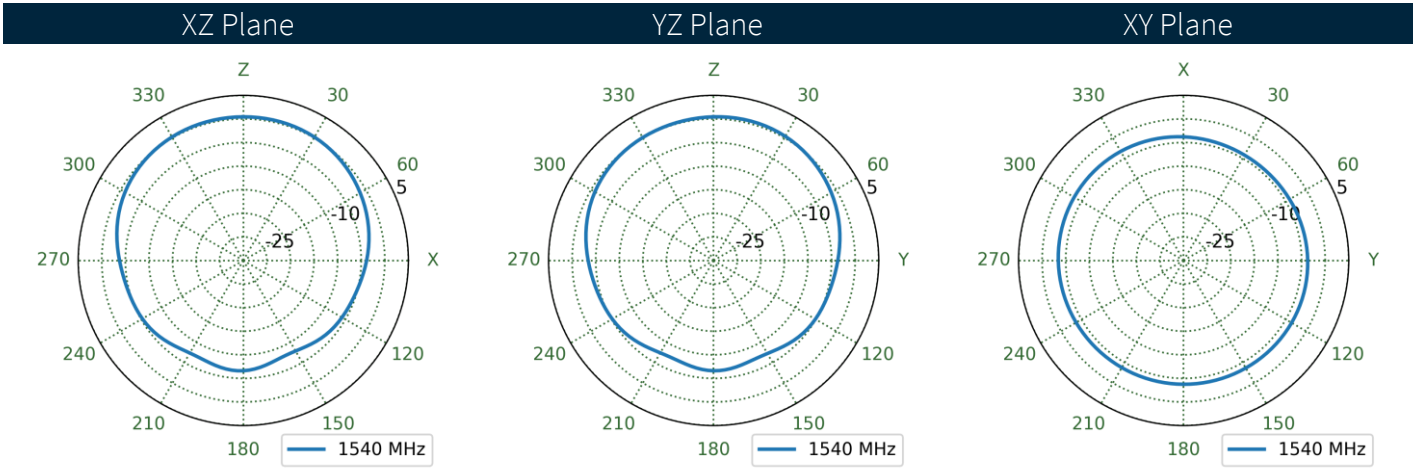
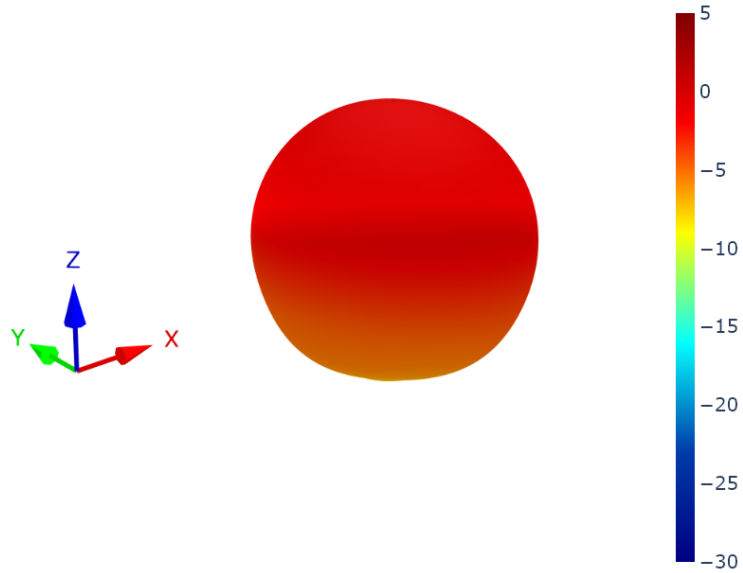

9.6 Free Space Patterns at 1560 MHz

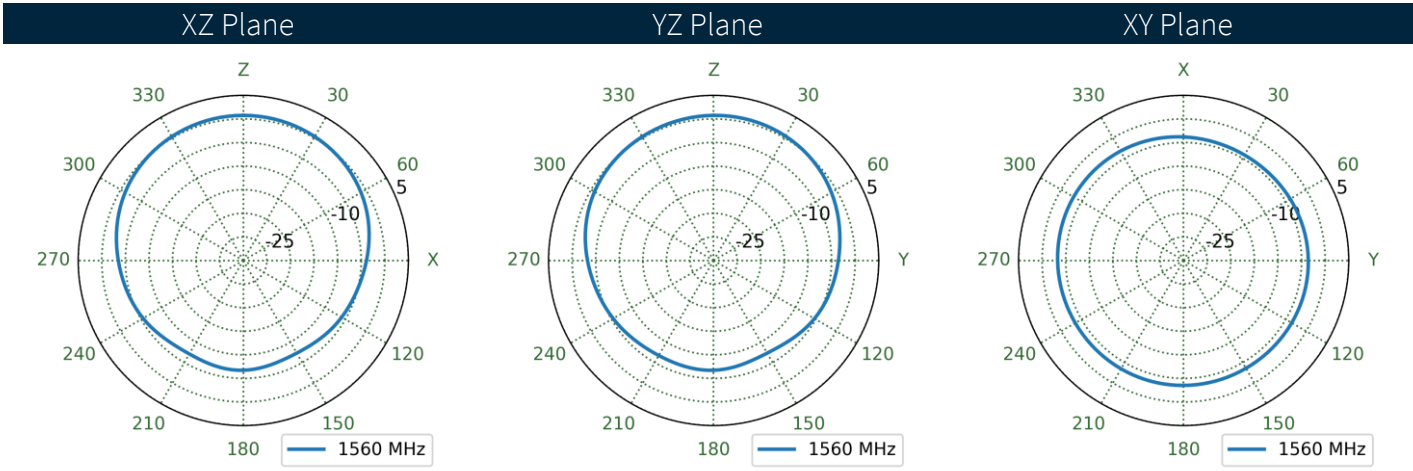
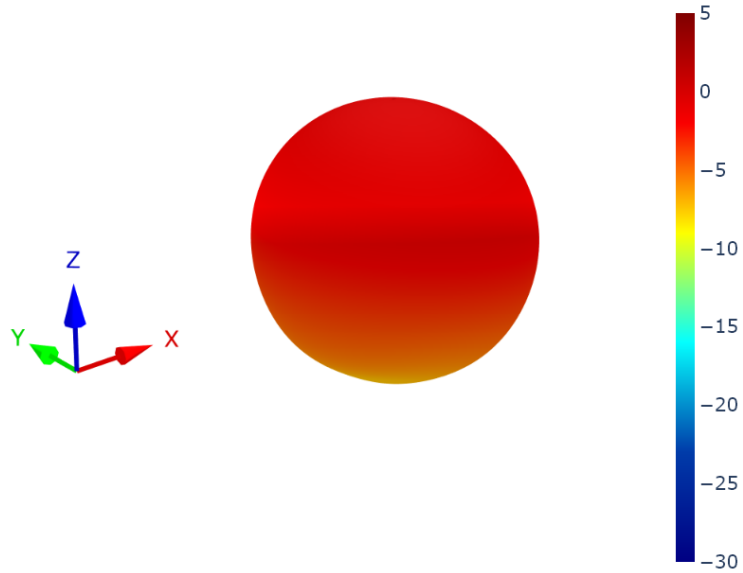

9.7 Free Space Patterns at 1575 MHz

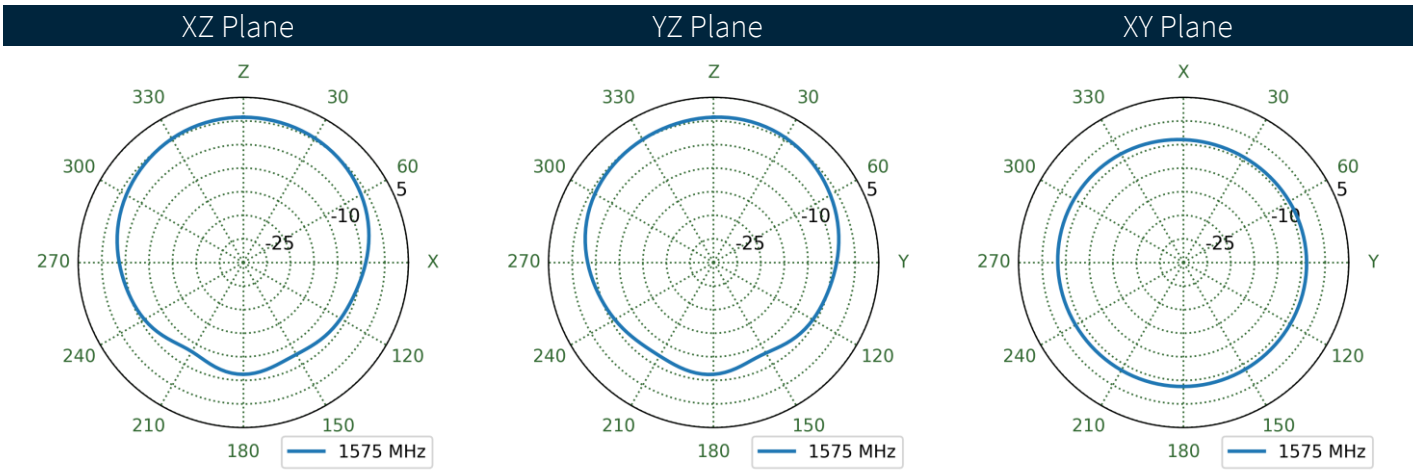
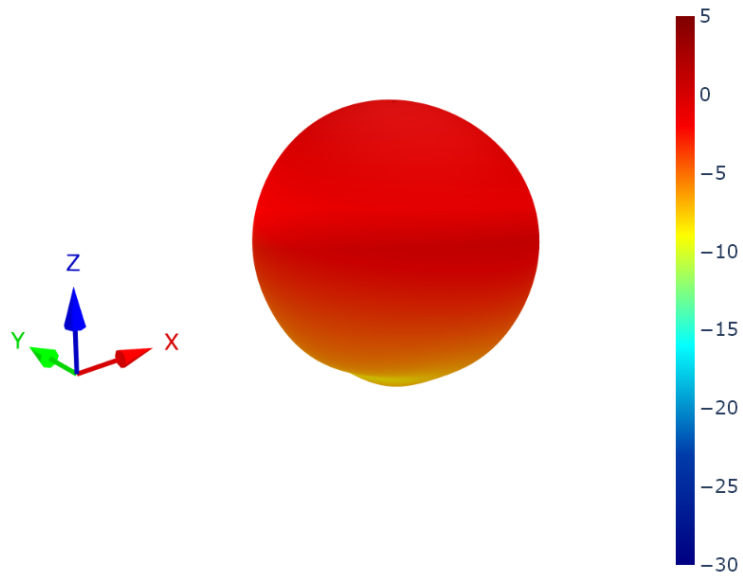

9.8 Free Space Patterns at 1605 MHz

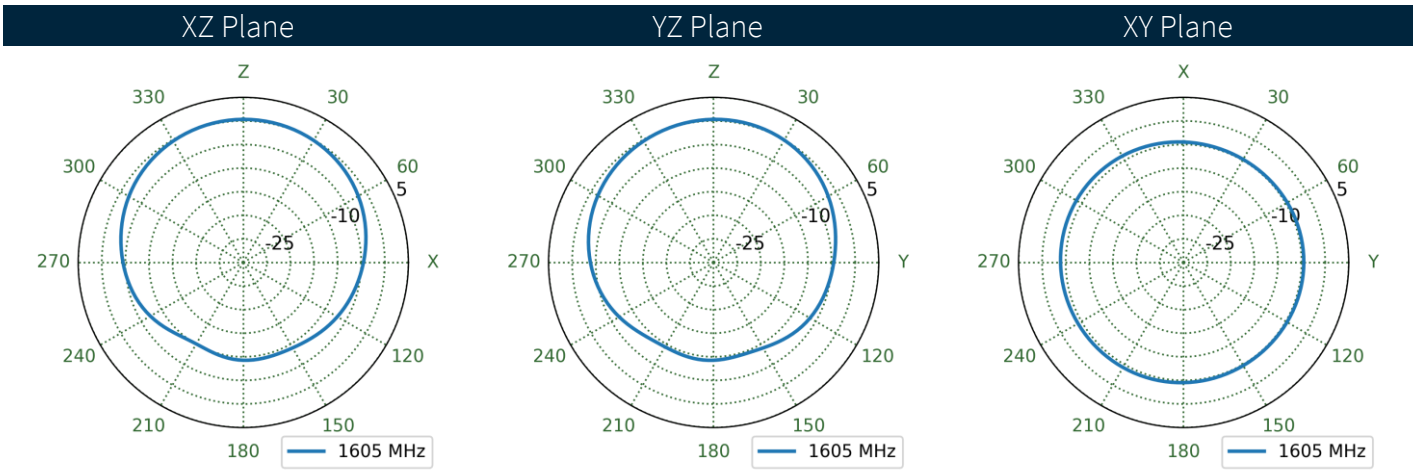
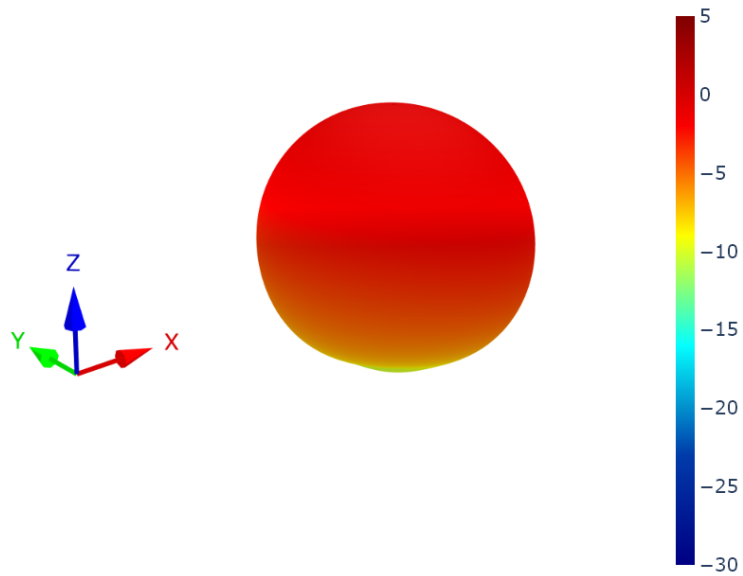

Changelog for the datasheet

SPE-24-8-138-A – TS.125.0111W

Revision: A (Original First Release)

Date: 2024-06-04

Notes: Initial Release

Author: Gary West

Previous Revisions



www.taoglas.com

